

KOBELCO

The Worldwide Manufacturer

KOBELCO

WELDING HANDBOOK

KOBELCO

WELDING HANDBOOK

WELDING CONSUMABLES AND PROCESSES

FAMILIARC™

TRUSTARC™

PREMIARC™

 **KOBE STEEL, LTD.**
Welding Company

KOBELCO KOBE STEEL, LTD.
WELDING COMPANY

2009

Overall Index

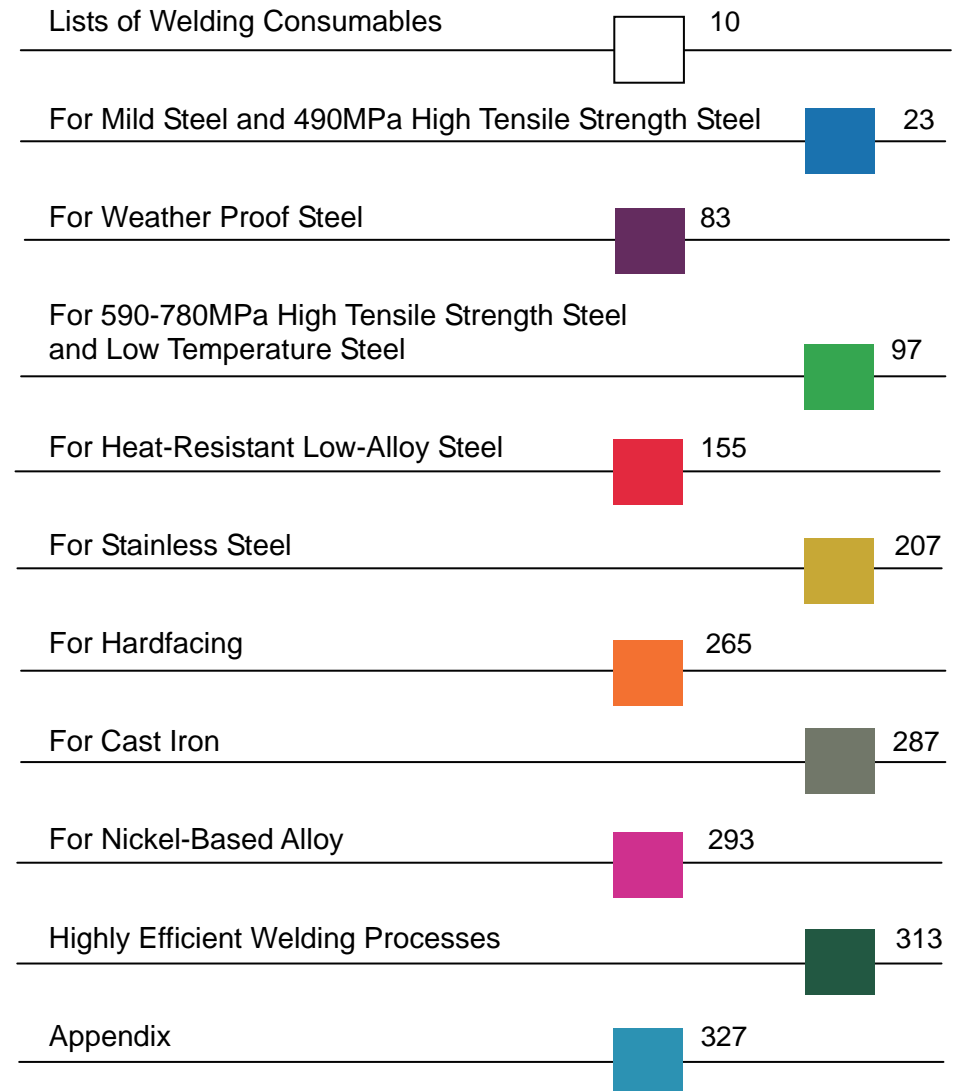

• For your further information of welding consumable specifications, classifications, approvals and packages, please contact the nearest Kobelco office or sales representative.

Notification

We, Welding Company of Kobe Steel, Ltd., thank you very much for your continuous patronage of our products and services. We have changed the designation system of welding consumable as described in the following from April 2008. However, the technical design of the products is not changed.

New group brand names and the corresponding products

All KOBELCO welding consumables are designated with "Trade Designation" and are grouped into the following three new groups on the basis of the characteristics of individual products as detailed below.

(1) **FAMILIARC™** (Famili-Arc)

A coined word produced by combining "Familiar" and "Arc."

Welding consumables grouped into this group are used for general welded structures made of mild steels and high tensile strength steels that have the tensile strength of less than 590 MPa.

(2) **TRUSTARC™** (Trust-Arc)

A coined word produced by combining "Trust" and "Arc."

Welding consumables grouped into this group are used for such steels that require highly credible qualities as high tensile strength steels with the tensile strength of 570 MPa and higher, low temperature steels, and heat-resistant low-alloy steels.

(3) **PREMIARC™** (Premi-Arc)

A coined word produced by combining "Premium" and "Arc."

Welding consumables grouped into this group are used for high-alloy steels, stainless steels, and nonferrous metals.

The new group brand name (referred to as "Trademark" hereinafter) is put on the head of an individual trade designation. The trade designations are made by modifying the traditional brand names in accordance with the new designation system in which the position of hyphen is reviewed so that a hyphen comes after one letter or two letters. That is, the new brand name consists of "Trademark" and "Trade designation" as shown in the following. We are determined to control all the trade designations so that they can clearly be identified.

Examples of new and old brand names

Old brand name	New brand name
(1) B-10	FAMILIARC™ B-10
(2) MG-50	FAMILIARC™ MG-50
(3) TGS-50	FAMILIARC™ TG-S50
(4) MGS-50	FAMILIARC™ MG-S50
(5) ZERODE-44	FAMILIARC™ Z-44
(6) CMA-106N	TRUSTARC™ CM-A106N
(7) DW-308	PREMIARC™ DW-308

The purpose of changing the designation system

In recent years, we have found some other companies' products that have the same brand names as ours and false certificates that misrepresent our company's certificates in Japan and the Asian countries. In order to cope with this problem, we have taken legal actions against the impostors that could be verified and have required them to change their product names. However, it is difficult in the traditional product designation system to protect all of our products from imitation. Hence, we have established the new designation system of welding consumable to ensure the trademark right in main countries and to make our products identifiable more clearly, in which the particular group brand name, "Trademark," is put on the head of an individual "Trade Designation."

The new designation system is not only to prevent counterfeit products in Japan and overseas countries, but also to prevent our customers and users from suffering such a trouble in terms our products.

This modification may cause customers and users to modify their relevant documents. We sincerely hope for your understanding of the abovementioned situation and for your cooperation with us.

Note: The trademarks may be used with the following symbols in this booklet.
[F]: FAMILIARC™; [T]: TRUSTARC™; [P]: PREMIARC™.

Foreword

Note the following preliminary information on use of this welding handbook.

1. Standards for welding consumables are abbreviated as follows

JIS: Japanese Industrial Standard
 AWS: American Welding Society's Standard
 EN: European Norm
 ASME: American Society of Mechanical Engineers' Standard

2. Classifications for welding consumables are used in accordance with the following rules

Welding consumables are classified in accordance with basically the mechanical and/or chemical requirements of the standards, excluding such requirements as size, length, marking and identification manners. For details please contact the nearest Kobelco office or sales representative.

3. The test conditions of mechanical properties and hardness are as follows

- (1) Unless otherwise specified, impact values are obtained with Charpy 2mm-V notch specimens.
- (2) Unless otherwise specified, tension test and hardness test are carried out at room temperature.
- (3) Unless otherwise specified, tension test and hardness test are carried out in the as-welded condition.
- (4) The gauge length of tensile specimens is 4 x D (where D is the diameter) for testing at room temperature.
- (5) Unless otherwise specified, postweld heat treatment is followed by furnace cooling.
- (6) Unless otherwise specified, the testing method is as per AWS standard.
- (7) All mechanical and chemical data are given separately as "Example" (one of the manufacturer's laboratory test data) and "Guaranty" (the guaranty value as per AWS standard). Tensile strength and 0.2% offset strength are rounded as SI unit.

4. The weight per piece of covered electrode shows an approximate weight

Abbreviations and marks with definitions

This welding handbook uses the following abbreviations and marks if necessary.

Abbrev. and mark	Definition	Abbrev. and mark	Definition
AC	Alternating current or Air cooling	NL	Number of layer
A	Ampere	NR	Not required
AP	All positions	OD	Outer diameter
AW	As-welded	OQ	Oil quenching
Bal	Balance	OS	Offset strength
CR	Cooling rate	OSW	One-side welding
DBE	Distance between electrodes	Pol	Polarity
DC	Direct current	Pre. H	Preheat
DC-EN	DC, electrode negative	PT	Plate thickness
DC-EP	DC, electrode positive	PWHT	Postweld heat treatment
Dia.	Diameter	RA	Reduction of area
EGW	Electrode gas arc welding	RC	Redrying conditions
EI	Elongation	RG	Root gap
Ext	Extension of wire	RT	Room temperature
F	Flat position	SAW	Submerged arc welding
FC	Furnace cooling	SG	Shielding gas
FCW	Flux-cored wire	SMAW	Shielded metal arc welding
FCAW	Flux Cored Arc Welding	SR	Stress relief
GD	Groove design	SW	Solid wire
GMAW	Gas Metal Arc Welding	(T)	Trailing electrode
GS	Groove size	TIG	Tungsten inert gas
GTAW	Gas Tungsten Arc Welding	TS	Tensile strength
H	Horizontal position	Temp	Test temperature
HAZ	Heat-affected zone	V	Voltage
HF	Horizontal fillet	VD	Vertical-down position
HI	Heat input	VU	Vertical-up position
HT	High tensile	WP	Welding position
Hv	Hardness (Vickers)	WQ	Water quenching
I PT	Interpass temperature	YP	Yield point
IV	Impact value	≧	Maximum
L	Length	≦	Minimum
(L)	Leading electrode		
MS	Mild steel		
NE	Number of electrode		

Warning and Caution in Welding



Pay your attention to the following warnings and cautions for your safety and health during welding and related operations

 WARNING	Be sure to follow safety practices stated in the following in order to protect welders, operators and accompanied workers from a serious accident resulting in injury or death.
--	--



- Be sure to follow safety practices stated in the following when you use welding consumables.
- Be sure to follow safety practices stated in the instruction manual of welding equipment when you use it.

 WARNING	Electric shock can kill.
--	---------------------------------



- Do not touch live electrical parts (A covered electrode held with an electrode holder and a welding wire are electrically live).
- Wear dry, insulated gloves. Do not wear torn or wet gloves. Use an electric shock preventing device (e.g., open-circuit-voltage-reducing device) when welders or operators work in confined or high-level spaces. Use also a lifeline when welders or operators conduct welding at a high-level space.
- Follow safety practices stated in the instruction manual of welding machines before use. Do not use a welding machine the case or cover of which is removed. Welding cables must have an adequate size for the capacity expected. Welding cables must be kept in an appropriate condition and a damaged cable must be repaired or replaced with new one.

 CAUTION 	Fumes and gases generated during welding are dangerous to your health. Welding in confined spaces is dangerous because it can be a cause to suffocation by oxygen deficient.
---	---



- Keep your head out of the source of fumes or gases to prevent you from directly breathing high density fumes or gases.
- Use local exhaust ventilation, or wear respirators in order to prevent you from breathing fumes and toxic gases which cause toxication, poor health and suffocation by oxygen deficient.
- Use general ventilation during welding in a workshop. Particularly during welding in confined spaces, be sure to use adequate ventilation or respirators, and welding should be done at the presence of a trained supervisor.
- Do not conduct welding at where degreasing, solvent cleaning, spraying, or painting operations are carried out nearby. Welding work accompanied by these operations may cause generation of harmful gases.
- Use adequate ventilation or respirators with special attention during welding plated and coated steels.
- Use respirators, eye safety glasses and safety leather gloves when using welding fluxes in order to prevent you from flux dust.

 CAUTION 	Arc rays can injure eyes and burn skin.
---	--



- Wear hand shields with an adequate shade grade during welding operations and supervising the welding work. Select the correct shade grade for filter lenses and filter plates suitable for exact welding work by referring the standard JIS T81 41.
- Wear suitable protectors for protecting you from an arc ray; e.g., safety leather glove for welding, long sleeve shirt, foot cover, leather apron.
- Use, at need, shade curtains for welding by surrounding the welding areas in order to prevent accompanied workers from arc rays.

 	<p>CAUTION</p> <p>Fire and explosion can take place.</p>
--	--



- Never conduct welding at areas adjacent to highly inflammable materials. Remove combustibles so that spatters cannot ignite them. If combustibles cannot be removed, cover them with a noninflammable material.
- Do not weld vessels or pipes which contain combustibles or being sealed.
- Do not put a hot weldment close to combustibles right after welding finished.
- When welding ceilings, floors, walls, remove combustibles put at the other side of them.
- Any part of a welding wire, with exception of the portion appropriately extended from the tip of the torch, must be free from touching the electrical circuit of the base metal side.
- Fasten cable joints and seal them with an insulation tape. The cable of the base metal side should be connected as close as possible to the welding portion of the work.
- Prepare fire-extinguishing equipment at where welding is carried out, in order to cope with a possible accident.

 	<p>CAUTION</p> <p>Flying spatter and slag can injure eyes and cause skin burns.</p> <p>High temperature heat of welding can cause skin burns.</p>
--	--

- Wear safety glasses, safety leather gloves for welding, long sleeve shirts, foot covers, leather aprons, etc.
- Do not touch weldments while they are hot.

 	<p>CAUTION</p> <p>The tip of a welding wire and filler wire can injure eyes, faces, etc.</p>
--	--

- When take off the tip of a wire fastened in the spool, be sure to hold the tip of the wire.
- When check the wire feeding condition, do not direct the welding torch to your face.

 	<p>CAUTION</p> <p>Falling down or dropping welding consumables can injure you.</p>
--	--

- Wear safety shoes and pay your attention not to drop welding consumables on your body when carrying and handling them. Keep yourself in a correct posture not to cause a crick in your back while handling them.
- Follow the handling instructions shown on the surface of the pail pack wire packages when handle them.
- Pile up welding consumables in a correct way so as not to cause falling or dropping while they are stored or carried.

Lists of Welding Consumables

Welding Process	Trade designation	ASME/AWS	JIS	ASME		Page
				F No.	A No.	
For Mild Steel and 490MPa High Tensile Strength Steel						
SMAW	KOBE-6010	A5.1 E6010	-	5	1	40
	B-33	A5.1 E6013	Z3211 D4313	2	1	46
	RB-26	A5.1 E6013	Z3211 D4313	2	1	33
	TB-24	A5.1 E6013	Z3211 D4303	2	1	-
	TB-I24	A5.1 E6013	Z3211 D4303	2	1	-
	Z-44	A5.1 E6013	Z3211 D4303	2	1	46
	B-10	A5.1 E6019	Z3211 D4301	2	1	46
	B-14	A5.1 E6019	Z3211 D4301	2	1	32
	B-17	A5.1 E6019	Z3211 D4301	2	1	46
	BI-14	A5.1 E6019	Z3211 D4301	2	1	-
	LB-26	A5.1 E7016	Z3211 D4316	4	1	48
	LB-47	A5.1 E7016	Z3211 D4316	4	1	26
	LB-52	A5.1 E7016	Z3212 D5016	4	1	34
	LB-52RC	A5.1 E7016	Z3211 E4916	4	1	38
	LB-52U	A5.1 E7016	Z3211 D4316	4	1	35
	LB-M52	A5.1 E7016	Z3212 D5016	4	1	26
	LB-52A	A5.1 E7016	Z3212 D5016	4	1	48
	LB-57	A5.1 E7016	Z3212 D5316	4	-	48
	LT-B52A	A5.1 E7018	Z3212 D5016	4	1	50
	LB-52-18	A5.1 E7018	Z3212 D5016	4	1	36
	KOBE-7024	A5.1 E7024	-	1	1	39
	LB-26V	A5.1 E7048	Z3211 D4316	4	1	-
	LB-52T	A5.1 E7048	Z3212 D5016	4	1	48
	LB-52V	A5.1 E7048	Z3212 D5016	4	1	-
	LB-78VS	A5.1 E7048	-	4	1	43
	KOBE-7010S	A5.5 E7010-P1	-	3	-	41
	LB-76	A5.5 E7016-G	Z3212 D5316	4	1	48
	KOBE-8010S	A5.5 E8010-P1	-	3	-	42
	LB-88VS	A5.5 E8018-G	-	4	-	44
	LB-98VS	A5.5 E9018-G	-	4	-	45
LB-47A	-	Z3211 D4316	-	1	-	
LT-B50	-	Z3212 D5003	-	1	50	
FCAW	MX-100T	A5.18 E70C-6C/6M	Z3313 YFW-C50DM	6	1	59
	MX-A100	A5.18 E70C-6M	Z3313 YFW-A50DM	6	1	58
	DW-200	A5.20 E70T-1C	Z3313 YFW-C50DR	6	1	60

Welding Process	Trade designation	ASME/AWS	JIS	ASME		Page
				F No.	A No.	
FCAW	MX-100	A5.20 E70T-1C	Z3313 YFW-C50DM	6	1	62
	MX-200	A5.20 E70T-1C	Z3313 YFW-C50DM	6	1	56
	MX-200E	A5.20 E70T-9C	Z3313 YFW-C502M	6	1	57
	MX-200H	A5.20 E70T-1C	Z3313 YFW-C50DM	6	1	62
	MX-Z210	A5.20 E70T-1	Z3313 YFW-C50DM	6	1	-
	MX-A200	A5.20 E70T-1M	Z3313 YFW-A50DM	6	1	62
	DW-100	A5.20 E71T-1C	Z3313 YFW-C50DR	6	1	52
	DW-100E	A5.20 E71T-9C	Z3313 YFW-C502R	6	1	53
	DW-100V	A5.20 E71T-1C	Z3313 YFW-C50DR	6	1	60
	DW-50	A5.20 E71T-1C/1M, -9C/9M	Z3313 YFW-C50DR	6	1	55
	DW-A50	A5.20 E71T-1M	Z3313 YFW-A50DR	6	1	54
	DW-A51B	A5.20 E71T-5M-J	Z3313 YFW-A502B	6	1	60
	GMAW	MIX-50	A5.18 ER70S-3	Z3312 YGW16	6	1
MG-51T		A5.18 ER70S-6	Z3312 YGW12	6	1	65
MIX-50S		A5.18 ER70S-G	Z3312 YGW15	6	1	66
MG-50		A5.18 ER70S-G	Z3312 YGW11	6	1	64
MG-S50		A5.18 ER70S-G	Z3312 YGW16	6	1	66
MG-50D		-	-	-	-	-
MG-50T		A5.18 ER70S-G	Z3312 YGW12	-	1	66
GTAW	NO65G	A5.18 ER70S-2	Z3316 YGT50	6	1	70
	TG-S51T	A5.18 ER70S-6	Z3316 YGT50	6	1	69
	TG-S50	A5.18 ER70S-G	Z3316 YGT50	6	1	68
SAW	PF-H45/US-43	A5.17 F6A4-EL8	Z3183 S422-S	6	1	78
	MF-44/US-36	A5.17 F7A0-EH14	Z3183 S501-H	6	-	-
	MF-53/US-36	A5.17 F7A0-EH14	Z3183 S501-H	6	-	78
	G-50/US-36	A5.17 F7A2-EH14	Z3183 S502-H	6	-	72
	G-60/US-36	A5.17 F7A2-EH14	Z3183 S502-H	6	-	73
	G-80/US-36	A5.17 F7A2-EH14, F6P2-EH14	-	6	1	78
	MF-38A/US-36	A5.17 F7A4-EH14	Z3183 S502-H	6	-	-
	PF-H55E/US-36	A5.17 F7A4-EH14	Z3183 S502-H	6	1	80
	MF-300/US-36	A5.17 F7A6-EH14 F7P6-EH14	Z3183 S502-H	6	-	76
	MF-38/US-36	A5.17 F7A6-EH14 F7P6-EH14	Z3183 S502-H	6	-	74
	PF-I53ES/US-36L	-	-	-	-	-

Lists of Welding Consumables

Welding Process	Trade designation	ASME / AWS	JIS	ASME		Page
				F No.	A No.	
For Weather Proof Steel						
SMAW	LB-W52	A5.5 E7016-G	Z3214 DA5016G	4	-	86
	LB-W52B	A5.5 E7016-G	Z3214 DA5016W	4	-	86
	LB-W588	A5.5 E8016-C3	-	4	-	86
	LB-W62G	A5.5 E8018-W2	Z3214 DA5816W	4	-	86
FCAW	DW-588	A5.29 E81T1-W2C	Z3320 YFA-58W	6	-	88
	DW-50W	-	Z3320 YFA-50W	-	-	88
GMAW	MG-W50TB	A5.28 ER80S-G	Z3315 YGA-50W	6	-	90
SAW	MF-53/US-W52B	A5.23 F7A0-EG-G	Z3183 S501-AW	6	-	92
	MF-38/US-W52B	A5.23 F7A2-EG-G	Z3183 S502-AW	6	-	92
	MF-38A/US-W52B	A5.23 F7A2-EG-G	Z3183 S502-AW	6	-	92
	MF-63/US-W62B	A5.23 F8A0-EG-G	Z3183 S581-AW	6	-	94
	MF-38/US-W62B	A5.23 F8A2-EG-G	Z3183 S582-AW	6	-	94
For 590-780MPa High Tensile Steel and Low Temperature Steel						
SMAW	LB-52LT-18	A5.1 E7018-1	-	4	1	104
	LB-7018-1	A5.1 E7018-1	-	4	1	104
	NB-3J	A5.5 E7016-C2L	Z3241 DL5016-10AP3	4	10	116
	LB-52NS	A5.5 E7016-G	Z3212 D5016	4	-	109
	NB-3N	A5.5 E7016-G	Z3241 DL5016-10P3	4	10	-
	NB-A52V	A5.5 E7016-G	Z3212 D5016	4	-	-
	NB-A52F	A5.5 E7018-G	Z3212 D5026	4	-	-
	LB-62L	A5.5 E8016-C1	-	4	10	111
	NB-2	A5.5 E8016-C1	Z3241 DL5016-6AP2	4	10	-
	LB-65L	A5.5 E8016-C1	Z3212 D6216	4	10	116
	NB-1SJ	A5.5 E8016-G	Z3241 DL5016-6AP1	4	10	110
	LB-62	A5.5 E9016-G	Z3212 D5816	4	-	106
	LB-62N	A5.5 E9016-G	Z3212 D5816	4	10	-
	LB-62U	A5.5 E9016-G	Z3211 E6216-N1M1 U	4	-	108
	LB-62UL	A5.5 E9016-G	Z3212 D5816	4	-	107
	LB-67L	A5.5 E9016-G	Z3211 E6216-N5M1L	4	10	112
	LB-62D	A5.5 E9018-G	Z3212 D5816	4	-	116
	LB-106	A5.5 E10016-G	Z3212 D7016	4	-	116
	LB-70L	A5.5 E10016-G	-	4	-	113
	LB-116	A5.5 E11016-G	Z3212 D8016	4	12	116
	LB-80UL	A5.5 E11016-G	Z3212 D8016	4	12	116

Welding Process	Trade designation	ASME / AWS	JIS	ASME		Page
				F No.	A No.	
SMAW	LB-88LT	A5.5 E11016-G	Z3212 D8016	4	12	115
	LB-80L	A5.5 E11018-G H4	-	4	-	114
FCAW	MX-55LF	A5.20 E70T-9C-J	Z3313 YFL-C506M	6	-	132
	DW-A55ESR	A5.20 E71T-12M-J	-	6	1	132
	DW-55E	A5.20 E71T-9C-J	Z3313 YFL-C504R	6	-	118
	DW-A55E	A5.20 E71T-9M-J	Z3313 YFL-A504R	6	1	119
	MX-A55T	A5.28 E80C-G	-	6	10	132
	MX-A55Ni1	A5.28 E80C-G	-	6	-	129
	MX-A80L	A5.28 E110C-G H4	-	6	-	130
	DW-50LSR	A5.29 E71T1-GC	Z3313 T496T1-1CA-N1	6	-	120
	DW-55L	A5.29 E81T1-K2C	Z3313 YFL-C506R	6	10	122
	DW-55LSR	A5.29 E81T1-K2C	Z3313 YFL-C506R	6	10	124
	DW-62L	A5.29 E91T1-Ni2C-J	-	6	10	126
	DW-A55L	A5.29 E81T1-K2M	-	6	10	123
	DW-A55LSR	A5.29 E81T1-Ni1M	-	6	10	125
	DW-A62L	A5.29 E91T1-GM	-	6	10	127
	DW-A65L	A5.29 E91T1-K2M-J	-	6	10	128
	DW-A81Ni1	A5.29 E81T1-Ni1M-J	-	6	10	121
GMAW	MG-S50LT	A5.18 ER70S-G	Z3325 YGL1-6A(AP)	6	-	138
	MG-S1N	A5.28 ER70S-G	Z3325 YGL2-6A(P)	6	10	138
	MG-S3N	A5.28 ER70S-G	Z3325 YGL3-10G(P)	6	-	138
	MG-60	A5.28 ER80S-G	Z3312 YGW21	6	-	134
	MG-T1NS	A5.28 ER80S-G	Z3325 YGL-6A(A)	6	10	98
	MG-S63B	A5.28 ER90S-G	Z3312 YGW23	6	-	134
	MG-70	A5.28 ER100S-G	-	6	-	134
	MG-S70	A5.28 ER100S-G	-	6	12	134
	MG-80	A5.28 ER110S-G	-	-	-	136
	MG-S80	A5.28 ER110S-G	-	6	-	136
	MG-S88A	A5.28 ER120S-G	-	6	-	136
GTAW	TG-S1N	A5.28 ER70S-G	-	6	-	142
	TG-S3N	A5.28 ER70S-G	-	6	10	142
	TG-S60A	A5.28 ER80S-G	Z3316 YGT62	6	-	140
	TG-S62	A5.28 ER80S-G	Z3316 YGT60	6	2	140
	TG-S80AM	A5.28 ER110S-G	Z3316 YGT80	6	-	140

Lists of Welding Consumables

Welding Process	Trade designation	ASME / AWS	JIS	ASME		Page
				F No.	A No.	
SAW	MF-38/US-49A	A5.17 F7A6-EH14 F7P6-EH14	-	6	-	152
	PF-H55S/US-49A	A5.17 F7A6-EH14 F7P6-EH14	-	6	1	98
	PF-H55LT/US-36	A5.17 F7A8-EH14	-	6	1	150
	PF-H55AS/US-36J	A5.17 F7P8-EH14	-	6	1	151
	PF-H203/US-203E	A5.23 F7P15-ENi3-Ni3	-	6	10	152
	MF-38A/US-A4	A5.23 F8A4-EA4-A4	Z3183 S584-H	6	2	-
	MF-38/US-A4	A5.23 F8A4-EA4-A4 F8P6-EA4-A4	Z3183 S584-H	6	2	146
	MF-38A/US-49	A5.23 F8A4-EG-A4	Z3183 S584-H	6	2	-
	MF-38/US-49	A5.23 F8A4-EG-A4 F8P6-EG-A4	Z3183 S584-H	6	-	144
	PF-H55S/US-255	A5.23 F9A5-EG-G F8P5-EG-G	-	6	-	-
	MF-38/US-40	A5.23 F9A6-EA3-A3 F8P6-EA3-A3	Z3183 S624-H1	6	-	147
	MF-38/US-70	A5.23 F10A6-EG-G	Z3183 S704-H1	6	-	-
	PF-H80AS/US-80LT	A5.23 F11A10-EG-G	-	6	-	149
	PF-H80AK/US-80BN	A5.23 F11A4-EG-G	Z3183 S804-H4	6	-	152
	PF-H80AK/US-80LT	A5.23 F12A10-EG-G	-	6	-	148

For Heat-Resistant Low-Alloy Steel

SMAW	BL-76	A5.1 E7016	Z3212 D5016	4	-	-
	BL-96	A5.5 E9016-G	-	4	-	156
	BL-106	A5.5 E10016-G	-	4	-	156
	CM-B95	A5.5 E7015-B2L	Z3223 DT2315	4	3	172
	CM-A76	A5.5 E7016-A1	Z3223 DT1216	4	2	172
	CM-B83	A5.5 E8013-G	-	2	3	156
	CM-B105	A5.5 E8015-B3L	Z3223 DT2415	4	4	172
	CM-B86	A5.5 E8016-B1	-	4	3	156
	CM-A96	A5.5 E8016-B2	Z3223 DT2316	4	3	162
	CM-A96MB	A5.5 E8016-B2	Z3223 DT2316	4	3	163
	CM-A96MBD	A5.5 E8016-B2	-	4	3	163
	CM-5	A5.5 E8016-B6	Z3223 DT2516	4	4	174
	CM-9	A5.5 E8016-B8	Z3223 DT2616	4	5	168
	CM-B98	A5.5 E8018-B2	Z3223 DT2318	4	3	172
	CM-A106	A5.5 E9016-B3	Z3223 DT2416	4	4	164
	CM-A106N	A5.5 E9016-B3	Z3223 DT2416	4	4	165
	CM-A106ND	A5.5 E9016-B3	-	4	4	165

Welding Process	Trade designation	ASME / AWS	JIS	ASME		Page
				F No.	A No.	
SMAW	CM-95B9	A5.5 E9015-B9	-	4	5	170
	CM-96B9	A5.5 E9016-B9	-	4	5	170
	CM-9Cb	A5.5 E9016-G	-	4	-	169
	CM-B108	A5.5 E9018-B3	Z3223 DT2418	4	4	172
	CM-2CW	-	-	4	-	174
	CM-A106H	-	-	-	4	166
	CM-A106HD	-	-	-	4	167
	CR-12S	-	-	-	-	171
	GMAW	MG-S5CM	A5.28 ER80S-B6	Z3317 YG5CM-A	6	4
MG-S9CM		A5.28 ER80S-B8	-	6	5	178
MG-S56		A5.28 ER80S-G	-	6	-	176
MG-S1CM		A5.28 ER80S-G	Z3317 YG1CM-A	6	3	176
MG-SM		A5.28 ER80S-G	Z3317 YGM-A	6	2	176
MG-S9Cb		A5.28 ER90S-G	-	6	-	178
MG-S2CM		A5.28 ER90S-G	Z3317 YG2CM-A	6	4	176
MG-1CM		A5.28 ER80S-G	Z3317 YG1CM-C	6	3	157
MG-CM		A5.28 ER80S-G	Z3317 YGCM-C	6	3	157
MG-M		A5.28 ER80S-G	Z3317 YGM-C	6	2	157
MG-T1CM		A5.28 ER80S-G	Z3317 YG1CM-A	6	3	-
MG-TM		A5.28 ER80S-G	Z3317 YGM-A	6	2	-
MG-2CM		A5.28 ER90S-G	Z3317 YG2CM-C	6	4	157
MG-S63S		A5.28 ER90S-G	-	6	-	157
MG-T2CM		A5.28 ER90S-G	Z3317 YG2CM-A	6	4	-
MG-S2CMS	A5.28 ER90S-G	Z3317 YG2CM-A	6	4	-	
GTAW	TG-S5CM	A5.28 ER80S-B6	Z3316 YGT5CM	6	4	188
	TG-S9CM	A5.28 ER80S-B8	-	6	5	185
	TG-S1CML	A5.28 ER80S-G	Z3316 YGT1CML	6	3	180
	TG-S2CML	A5.28 ER80S-G	Z3316 YGT2CML	6	4	182
	TG-S56	A5.28 ER80S-G	-	6	11	188
	TG-S63S	A5.28 ER90S-G	-	6	12	188
	TG-S1CM	A5.28 ER80S-G	Z3316 YGT1CM	6	3	180
	TG-SM	A5.28 ER80S-G	Z3316 YGTM	6	2	188
	TG-S80B2	A5.28 ER80S-B2	-	6	3	181
	TG-S90B3	A5.28 ER90S-B3	-	6	4	183

Lists of Welding Consumables

Welding Process	Trade designation	ASME / AWS	JIS	ASME		Page
				F No.	A No.	
GTAW	TG-S90B9	A5.28 ER90S-B9	-	6	5	187
	TG-S2CM	A5.28 ER90S-G	Z3316 YGT2CM	6	4	182
	TG-S9Cb	A5.28 ER90S-G	-	6	5	186
	TG-S12CRS	-	-	-	-	188
	TG-S2CMH	-	-	-	4	184
	TG-S2CW	-	-	6	-	188
	TG-SCM	-	-	-	3	157
SAW	PF-200S/US-502	A5.23 F7P2-EG-B6	Z3183 S502-5CM	6	4	204
	MF-29A/US-511	A5.23 F7PZ-EG-B2	Z3183 S641-1CM	6	3	204
	PF-200/US-511N	A5.23 F8P2-EG-B2	Z3183 S642-1CM	6	3	194
	PF-200D/US-511ND	A5.23 F8P2-EG-B2	-	6	3	195
	MF-29A/US-521	A5.23 F8P2-EG-B3	Z3183 S571-2CM	6	4	204
	MF-38/US-A4	A5.23 F8P6-EA4-A4 F8A4-EA4-A4	-	6	2	192
	MF-38/US-49	A5.23 F8P6-EG-A4 F8A4-EG-A4	Z3183 S584-H	6	-	190
	MF-38/US-40	A5.23 F8P6-EA3-A3 F9A6-EA3-A3	Z3183 S624-H1	6	-	193
	PF-200/US-521S	A5.23 F9P2-EG-B3	Z3183 S642-2CM	6	4	196
	PF-200D/US-521S	A5.23 F9P2-EG-B3	-	6	4	197
	MF-27/US-56B	A5.23 F9P4-EG-G	Z3183 S642-MN	6	-	202
	PF-200/US-56B	A5.23 F9P4-EG-G	Z3183 S642-MN	6	-	202
	PF-90B9/US-90B9	A5.23 F9PZ-EB9-B9	-	6	-	-
	MF-29AX/US-63S	A5.23 F10P2-EG-G	Z3183 S642-MN	6	-	-
	PF-200/US-63S	A5.23 F10P2-EG-G	Z3183 S642-MN	6	-	157
	PF-200S/US-9Cb	A5.23 F10PZ-EG-G	-	6	-	200
	PF-500/US-521H	-	-	-	4	198
	PF-500D/US-521HD	-	-	-	4	199
	PF-90B9/US-90B9	-	-	-	-	201
	For Stainless Steel					
SMAW	NC-16H	A5.4 E16-8-2-16	Z3221 D16-8-2-16	5	8	-
	NC-38	A5.4 E308-16	Z3221 D308-16	5	8	216
	NC-38H	A5.4 E308H-16	Z3221 D308-16	5	8	218
	NC-38LT	A5.4 E308L-16	Z3221 D308L-16	5	8	226

Welding Process	Trade designation	ASME / AWS	JIS	ASME		Page
				F No.	A No.	
SMAW	NC-38L	A5.4 E308L-16	Z3221 D308L-16	5	8	217
	NC-39	A5.4 E309-16	Z3221 D309-16	5	8	219
	NC-39L	A5.4 E309L-16	Z3221 D309L-16	5	8	220
	NC-39MoL	A5.4 E309MoL-16	Z3221 D309MoL-16	5	8	221
	NC-30	A5.4 E310-16	Z3221 D310-16	5	9	208
	NC-32	A5.4 E312-16	Z3221 D312-16	5	-	208
	NC-36	A5.4 E316-16	Z3221 D316-16	5	8	222
	NC-36L	A5.4 E316L-16	Z3221 D316L-16	5	8	223
	NC-36LT	A5.4 E316L-16	Z3221 D316L-16	5	8	226
	NC-317L	A5.4 E317L-16	Z3221 D317L-16	5	8	226
	NC-318	A5.4 E318-16	Z3221 D318-16	5	8	-
	NC-37	A5.4 E347-16	Z3221 D347-16	5	8	228
	NC-37L	A5.4 E347-16	Z3221 D347L-16	5	8	228
	CR-40	A5.4 E410-16	Z3221 D410-16	4	6	224
	CR-40Cb	-	Z3221 D410Nb-16	-	7	224
	CR-43	A5.4 E430-16	Z3221 D430-16	4	7	225
	CR-43Cb	-	Z3221 D430Nb-16	-	7	225
	CR-43CbS	-	-	-	7	225
	NC-316MF	-	-	-	-	228
	NC-329M	-	-	-	8	228
FCAW	DW-329A	A5.22 E2209T0-1/4	-	6	8	241
	DW-329AP	A5.22 E2209T1-1/4	-	6	8	242
	DW-308H	A5.22 E308HT1-1/4	Z3323 YF308C	6	8	244
	DW-308L	A5.22 E308LT0-1/4	Z3323 YF308LC	6	8	231
	DW-308LT	A5.22 E308LT0-1/4	Z3323 YF308LC	6	8	248
	DW-308LH	A5.22 E308LT1-1/4	Z3323 YF308LC	6	8	244
	DW-308LP	A5.22 E308LT1-1/4	Z3323 YF308LC	6	8	232
	DW-308	A5.22 E308T0-1/4	Z3323 YF308C	6	8	230
	DW-309MoL	A5.22 E309LMoT0-1/4	Z3323 YF309MoLC	6	8	236
	DW-309MoLP	A5.22 E309LMoT1-1/4	Z3323 YF309MoLC	6	8	237
	DW-309L	A5.22 E309LT0-1/4	Z3323 YF309LC	6	8	234
	DW-309LP	A5.22 E309LT1-1/4	Z3323 YF309LC	6	8	235
	DW-309	A5.22 E309T0-1/4	Z3323 YF309C	6	8	233
DW-309LH	A5.22 E309LT1-1/4	Z3323 YF309LC	6	8	244	

Lists of Welding Consumables

Welding Process	Trade designation	ASME / AWS	JIS	ASME		Page
				F No.	A No.	
FCAW	DW-310	A5.22 E310T0-1/4	-	6	9	248
	DW-312	A5.22 E312T0-1	-	6	-	248
	DW-316L	A5.22 E316LT0-1/4	Z3323 YF316LC	6	8	239
	DW-316LT	A5.22 E316LT1-1/4	Z3323 YF316LC	6	8	250
	DW-316LH	A5.22 E316LT1-1/4	Z3323 YF316LC	6	8	246
	DW-316LP	A5.22 E316LT1-1/4	Z3323 YF316LC	6	8	240
	DW-316	A5.22 E316T0-1/4	Z3323 YF316C	6	8	238
	DW-316H	A5.22 E316T1-1/4	Z3323 YF316C	6	8	246
	DW-317L	A5.22 E317LT0-1/4	Z3323 YF317LC	6	8	250
	DW-347	A5.22 E347T0-1/4	Z3323 YF347C	6	8	250
	DW-347H	A5.22 E347T1-1/4	Z3323 YF347C	6	8	246
	TG-X308L	A5.22 R308LT1-5	-	-	8	256
	TG-X309L	A5.22 R309LT1-5	-	-	8	257
	TG-X316L	A5.22 R316LT1-5	-	-	8	258
	TG-X347	A5.22 R347T1-5	-	-	8	259
	DW-2101	-	-	-	-	250
	DW-410Cb	-	-	-	7	209
	DW-430CbS	-	-	-	7	209
	MX-A135N	-	-	-	-	252
	MX-A410NM	-	-	-	-	252
MX-A430M	-	-	-	7	252	
GMAW	MG-S308	A5.9 ER308	Z3321 Y308	6	8	254
	MG-S308LS	A5.9 ER308LSi	Z3321 Y308LSi	6	8	254
	MG-S309	A5.9 ER309	Z3321 Y309	6	8	254
	MG-S309LS	A5.9 ER309LSi	Z3321 Y309Si	6	8	254
	MG-S316LS	A5.9 ER316LSi	Z3321 Y316LSi	6	8	254
	MG-S347S	A5.9 ER347Si	Z3321 Y347Si	6	8	209
	MG-S430M	-	-	-	-	209
GTAW	TG-S308	A5.9 ER308	Z3321 Y308	6	8	260
	TG-S308L	A5.9 ER308L	Z3321 Y308L	6	8	260
	TG-S309	A5.9 ER309	Z3321 Y309	6	8	260
	TG-S309L	A5.9 ER309L	Z3321 Y309L	6	8	260
	TG-S309MoL	A5.9 ER309LMo	Z3321 Y309Mo	-	8	260

Welding Process	Trade designation	ASME / AWS	JIS	ASME		Page
				F No.	A No.	
GTAW	TG-S310	A5.9 ER310	Z3321 Y310	6	9	209
	TG-S316	A5.9 ER316	Z3321 Y316	6	8	260
	TG-S316L	A5.9 ER316L	Z3321 Y316L	6	8	260
	TG-S317L	A5.9 ER317L	Z3321 Y317L	6	8	262
	TG-S347	A5.9 ER347	Z3321 Y347	6	8	262
	TG-S410	A5.9 ER410	Z3321 Y410	6	6	262
	TG-S310MF	-	-	-	-	262
	NO4051	-	-	-	-	262
	TG-S329M	-	-	-	-	262
	TG-S410Cb	-	-	-	7	262
SAW	PF-S1/US-308	A5.9 ER308	Z3324 S308	6	8	209
	PF-S1/US-308L	A5.9 ER308L	Z3324 S308L	6	8	209
	PF-S1/US-309	A5.9 ER309	Z3324 S309	6	8	209
	PF-S1/US-309L	A5.9 ER309L	Z3324 S309L	6	8	209
	PF-S1M/US-316	A5.9 ER316	Z3324 S316	6	8	209
	PF-S1M/US-316L	A5.9 ER316L	Z3324 S316L	6	8	209
	PF-S1/US-317L	A5.9 ER317L	Z3324 S317L	6	8	209
	PF-S1/US-347	A5.9 ER347	Z3324 S347	6	8	209
	PF-S4M/US-410	-	Z3324 SSG	-	7	209
	For Hardfacing					
SMAW	HF-240	-	Z3251 DF2A-250-R	-	-	270
	HF-260	-	Z3251 DF2A-300-B	-	-	270
	HF-330	-	Z3251 DF2A-350-R	-	-	270
	HF-350	-	Z3251 DF2A-400-B	-	-	270
	HF-450	-	Z3251 DF2A-450-B	-	-	272
	HF-500	-	Z3251 DF2B-500-B	-	-	272
	HF-600	-	Z3251 DF2B-600-B	-	-	272
	HF-650	-	Z3251 DF3C-600-B	-	-	272
	HF-700	-	Z3251 DF3C-600-B	-	-	274
	HF-800K	-	Z3251 DF3C-700-B	-	-	274
	HF-950	-	-	-	-	274
HF-1000	-	-	-	-	267	
HF-11	-	Z3251 DFMA-250-B	-	-	276	

Lists of Welding Consumables

Welding Process	Trade designation	ASME / AWS	JIS	ASME		Page
				F No.	A No.	
SMAW	HF-12	-	Z3251 DF3C-500-B	-	-	276
	HF-13	-	Z3251 DF4A-450-B	-	-	276
	HF-16	-	Z3251 DFME-300-B	-	-	276
	HF-30	-	Z3251 DFCrA-700-B	-	-	276
FCAW	DW-H250	-	Z3326 YF2A-C-250	-	-	278
	DW-H350	-	Z3326 YF2A-C-350	-	-	278
	DW-H450	-	Z3326 YF3B-C-450	-	-	278
	DW-H600	-	Z3326 YF3B-C-600	-	-	278
	DW-H700	-	Z3326 YF3B-C-700	-	-	278
	DW-H800	-	Z3326 YF3B-C-800	-	-	278
	DW-H11	-	Z3326 YFMA-C-250	-	-	280
	DW-H16	-	Z3326 YFME-C-300	-	-	280
	DW-H30	-	Z3326 YFCrA-C-700	-	-	280
	DW-H30MV	-	Z3326 YFCrA-C-800	-	-	280
SAW	G-50/US-H250N	-	-	-	-	282
	G-50/US-H350N	-	-	-	-	282
	G-50/US-H400N	-	-	-	-	282
	G-50/US-H450N	-	-	-	-	282
	G-50/US-H500N	-	-	-	-	284
	MF-30/US-H550N	-	-	-	-	284
	MF-30/US-H600N	-	-	-	-	284
For Cast Iron						
SMAW	CI-A1	A5.15 ENi-Ci	Z3252 DFCNi	-	-	290
	CI-A2	A5.15 ENiFe-Ci	Z3252 DFCNiFe	-	-	290
	CI-A3	A5.15 Est	Z3252 DFCFe	-	-	290
	CI-A5	-	-	-	-	290
For Nickel-Based Alloy						
SMAW	ME-L34	-	Z3224 DNiCu-1-15	-	-	300
	NI-C70A	A5.11 ENiCrFe-1	Z3224 DNiCrFe-1J-16	43	-	300
	NI-C703D	A5.11 ENiCrFe-3	Z3224 DNiCrFe-3-15	43	-	300
	NI-C70S	A5.11 ENiCrFe-9	Z3225 D9Ni-1	43	-	298
	NI-C1S	A5.11 ENiMo-8	Z3225 D9Ni-2	44	-	298
	NI-C625	-	-	-	-	300

Welding Process	Trade designation	ASME / AWS	JIS	ASME		Page
				F No.	A No.	
FCAW	DW-N70S	-	-	-	-	302
	DW-N82	A5.34 ENiCr3T0-4	-	-	-	302
	DW-N625	A5.34 ENiCrMo3T1-4	-	-	-	304
	DW-NC276	A5.34 ENiCrMo4T0-4	-	-	-	304
	DW-N625M	-	-	-	-	304
GMAW	MG-S70NCb	A5.14 ERNiCr-3	Z3334 YNiCr-3	43	-	306
GTAW	TG-S70NCb	A5.14 ERNiCr-3	Z3334 YNiCr-3	43	-	308
	TG-SN625	A5.14 ERNiCrMo-3	Z3334 YNiCrMo-3	43	-	308
	TG-S709S	A5.14 ERNiMo-8	Z3332 YGT9Ni-2	44	-	308
SAW	PF-N3/US-709S	A5.14 ERNiMo-8	Z3333 FS9Ni-F/YS9Ni	44	-	310
	PF-N4/US-709S	A5.14 ERNiMo-8	Z3333 FS9Ni-H/YS9Ni	44	-	310
Highly Efficient Welding Processes						
FCB™	PF-I50/US-43/ PF-I50R (MF-1R)	-	-	-	-	314
	PF-I55E/US-36/ PF-I50R (MF-1R)	-	-	-	-	314
RF™	PF-H55E/US-36/ RF-1	-	-	-	-	316
FA-B	MF-38/US-36/ RR-2/FA-B1	-	-	-	-	318
	MF-38/US-49/ RR-2/FA-B1	-	-	-	-	318
	PF-I52E/US-36/ RR-2/FA-B1	-	-	-	-	318
EGW	DW-S43G	A5.26 EG70T-2	Z3319 YFEG-22C	6	-	320
	DW-S1LG	-	-	-	-	320
	DW-S60G	-	Z3319 YFEG-32C	-	-	320
H-SAW	MF-33H/US-36	A5.17 F7A6-EH14 F7P6-EH14	Z3183 S502-H	6	-	322
	MF-33H/US-49	A5.23 F8A6-EG-A4 F8P6-EG-A4	Z3183 S624-H1	6	2	322
	MF-33H/US-49A	A5.17 F7A6-EH14 F7P6-EH14	-	6	-	322
EAW	LB-116	A5.5 E11016-G	Z3212 D8016	4	12	324
	LB-80EM	-	Z3212 D8000	-	-	324

Welding Consumables and Proper Welding Conditions for

- **Shielded Metal Arc Welding (SMAW)**
- **Flux Cored Arc Welding (FCAW)**
- **Gas Metal Arc Welding (GMAW)**
- **Gas Tungsten Arc Welding (GTAW)**
- **Submerged Arc Welding (SAW)**

For Mild Steel and 490MPa High Tensile Strength Steel

■ A guide for selecting the type of welding consumable ⁽¹⁾

Type of covering and AWS classification	High titania	Low hydrogen	Ilmenite ⁽²⁾	High cellulose	Lime titania ⁽³⁾	Iron-powder iron-oxide	Iron-powder titania
	E6013	E7016	E6019	E6010	E6013	E6027	E7024
Weldability							
•Crack resistant	△	⊙	○	○	○	△	△
•X-ray soundness	△	⊙	○	△	○	△	△
•Impact value	△	⊙	○	○	○	△	△
Usability							
•Suitability for particular welding positions	F	⊙	○	⊙	△	⊙	-
	F, HF	⊙	○	⊙	△	⊙	⊙
	VU	△	⊙	⊙	○	⊙	--
	VD	○	-(4)	-	⊙	△	-
•Bead appearance	OH	△	⊙	⊙	○	⊙	-
	F	⊙	△	○	△	⊙	-
	F, HF	⊙	△	○	△	⊙	⊙
•Penetration	V, OH	⊙	⊙	○	○	⊙	-
		△	○	⊙	⊙	○	△
•Spatter	⊙	○	○	△	○	○	○
•Slag removal	⊙	△	○	○	○	⊙	⊙
•Travel speed	○	△	○	△	⊙	⊙	⊙
•Suitability for thin metal	⊙	△	○	△	⊙	○	○

Note (1) ⊙: Excellent, ○: Good, △: Fair

F: Flat butt welding, F, HF: Flat and horizontal fillet welding, VU: Vertical-up welding, VD: Vertical-down welding, OH: Overhead welding, V, OH: Vertical and overhead welding

(2) The ilmenite type corresponds to the iron-oxide titania potassium type per the AWS standard.

(3) The lime titania type is not specified by the AWS standard, but exact products fall in the range of AWS E6013.

(4) Some low-hydrogen electrodes classified as E7048 are suitable exclusively for vertical-down welding.

■ Tips for better welding results

- (1) Slag and fumes on tack weld beads absorb moisture; therefore, they must be removed right after tack welding to prevent adverse effects on the subsequent main welding.
- (2) When wind velocity is more than 3m/sec in field welding, use a wind screen, or nitrogen in the wind decreases impact value and X-ray soundness of the weld.
- (3) In welding medium and heavy thick mild steels by using non-low-hydrogen electrodes, keep the work at appropriate preheat and interpass temperature to remove diffusible hydrogen and thereby prevent cracking in the weld.
- (4) In order to get better impact values, it is effective to lay each weld layer as thin as possible.
- (5) Many covered electrodes can be used with both AC and DC power sources. Low-hydrogen type electrodes, however, should be tested on mechanical properties beforehand, because DC current causes a little lower strength of the weld metal.
- (6) Low-hydrogen type electrodes are more suitable for surface finishing and repair welding of gas shielded metal arc and self-shielded metal arc welded deposits in order to prevent pits and blowholes.

■ How to keep covered electrodes in good condition

- (1) Store covered electrodes in a warehouse where the humidity is low.
- (2) Low-hydrogen type electrodes should be stored in an oven (100-150°C) placed near the welding area after re-drying was finished so that welders can take out the electrodes little by little. This manner is good for preventing the electrodes from moisture pick up and thereby decrease the diffusible hydrogen content of the weld metal.
- (3) A change of the color of the flux coating to become darker, much more spatter, stronger arc, and irregular slag-covering are signs that the electrodes picked up moisture excessively. In such a case, re-drying is effective even for non-low-hydrogen electrodes to improve usability and X-ray soundness. But excessive drying for long hours at high temperatures deteriorates X-ray soundness of the weld metal.
- (4) Welders should bring an appropriate amount of electrodes for half-a-day use at sites in order to prevent electrodes from excessive moisture pick up.

■ A guide for selecting filler metals for API grade pipes and comparison of welding procedures ⁽¹⁾

API 5L pipe grade	Welding pass	With high cellulose electrodes	With low hydrogen electrodes		
		Downhill welding process	Uphill welding process	Downhill welding process	
				With only low hydrogen electrodes	With a combination of high cellulose and low hydrogen electrodes
A25 A, B X42 X46 X52	Root	KOBE-6010 KOBE-7010S	LB-52U	LB-78VS	KOBE-6010 KOBE-7010S
	Hot		LB-47		
	Filler and cap		LB-52 LB-M52 LB-52-18		
X56	Root	KOBE-6010 KOBE-7010S	LB-52U	LB-78VS	KOBE-6010 KOBE-7010S
	Hot		LB-52		
	Filler and cap		LB-M52 LB-52-18		
X60	Root	KOBE-6010 KOBE-7010S	LB-52U	LB-78VS LB-88VS	KOBE-6010 KOBE-7010S
	Hot		LB-52		
	Filler and cap		KOBE-7010S KOBE-8010S LB-52-18		
X65	Root	KOBE-7010S KOBE-8010S	LB-52U	LB-88VS	KOBE-7010S KOBE-8010S
	Hot		LB-57		
	Filler and cap		LB-62 LB-62D		
X70	Root	KOBE-7010S KOBE-8010S	LB-62U	LB-88VS	KOBE-7010S KOBE-8010S
	Hot		LB-62		
	Filler and cap		LB-62D		
X80	Root	-	LB-62U	LB-98VS	KOBE-7010S KOBE-8010S
	Hot		LB-65D		
	Filler and cap				
Weldability					
•Stability of root pass		○	⊙	△	○
•Weld soundness		○	⊙	○	○
•Crack resistance		△	⊙	⊙	○
Welding efficiency		⊙	△	○	⊙
Groove size tolerance		○	⊙	△	○

Note (1) ⊙: Excellent, ○: Fair, △: Inferior

■ Tips for better welding results

1) Sizes and tolerances of welding grooves

In one-side butt welding of pipes, it is important to make sound root pass welds without incomplete joint penetration and other discontinuities. For this, it is essential to prepare welding grooves suitable for individual welding procedures. Refer to the recommended sizes and tolerances of the grooves shown in the table below.

Welding consumable	Welding process	Recommendation and tolerance	Groove angle (deg.)	Root face (mm)	Root gap (mm)	Misalignment (mm)
High cellulose electrodes	Downhill welding	Recommendation	60-70	1.2-2.4 (1.2-2.0)	1.2-2.0	≤ 0.8
		Tolerance	50-75	0.8-2.4	0.8-2.4	≤ 1.6
Low hydrogen electrodes	Uphill welding	Recommendation	60-80 (70-80)	0.4-2.0	2.0-3.2 (2.0-2.6)	≤ 1.6 (≤ 0.8)
		Tolerance	55-90	0.4-2.4	1.6-3.6	≤ 2.0
	Downhill welding	Recommendation	60-80	1.2-2.0	2.6-3.4 (2.6-3.2)	≤ 0.6
		Tolerance	55-90	1.0-2.0	2.5-3.5	≤ 1.0

Note: Recommended ranges in parentheses are suitable for small diameter tubes with an approximate thickness of 7mm or less.

2) How to proceed root pass welding

(1) Downhill welding should be started at the 11 to 1 o'clock position of a pipe, whereas uphill welding should be started at the 5 to 7 o'clock position in common procedures. However, welding should be started at where there is a narrower root opening.

(2) It is recommended to strike an arc on the groove face and transfer the arc to the root of the groove, maintaining the arc in stable condition.

(3) Joint penetration can be adjusted by controlling the shape of a keyhole molten crater by adjusting welding current, electrode holding angle, the extent of sticking an electrode into the root opening, and weaving width. Control the penetration more strictly particularly at the 12 o'clock position where reverse side bead extrusion tends to be excessive and the 6 o'clock position that tends to cause a concave reverse side beads.

(4) Before joining beads particularly with low hydrogen electrodes, the end of the preceding bead should be tapered by grinding.

(5) After the completion of root pass welding, remove slag and unacceptable portion of beads, and shape the beads along the entire circumference of the pipe by grinding. Particularly, where the weld surfaces contain deep undercut, the shaping should be conducted more carefully.

For Mild Steel and 490MPa High Tensile Strength Steel

Types and features of flux-cored wires

There are two types of flux cored wires: DW series rutile type and MX series metal type. Both DW and MX series include a variety of wires that use either CO₂ or Ar-CO₂ admixture shielding gas. The following paragraphs describe essential characteristics of both types of flux-cored wires to provide users with a useful guide.

DW series:

DW series is the most popular type of flux-cored wire, most of which contains rutile flux. This series offers excellent weldability with good arc stability and very low spatter generation. With CO₂ or Ar-CO₂ admixture shielding gas, DW wires show good slag removability and smooth, glossy bead appearance. Because of high deposition rates, highly efficient welding can be conducted. DW series includes those suitable for out-of-position welding and those suitable for horizontal fillet welding for a variety of applications.

MX series:

MX series is metal type flux-cored wire. Due to high deposition rates, highly efficient welding can be conducted. MX wires offer excellent weldability with good arc stability and low spatter generation. With some wires, the amount of slag is as little as in gas metal arc welding with solid wires; therefore, multi-pass welding can continuously be conducted without removing the slag on each pass. A variety of MX wires are available to cover wide applications of thin plate, medium and thick plate, and primer-coated plates.

Deposition rate:

Compared at the same welding current, the deposition rates of flux-cored wires are higher by 50 - 60% relative to stick electrodes and 10 - 20% higher than solid wires. Spatter generation in use of flux-cored wires is much lower than in use of solid wires.

Tips for better welding results

In addition to the tips for gas metal arc welding with solid wires, the following tips especially for flux-cored wires are essential to use the excellent features of the wires.

- (1) Because the wire is softer than solid wire, do not excessively tighten the pressure roller of the wire feeder so as not to cause the deformation of the wire.
- (2) In flat butt welding, backhand technique is better for stable penetration. In horizontal and overhead fillet welding, forehand technique is better for flat bead appearance.
- (3) In vertical down fillet welding, the first layer run should be straight and keep the welding speed faster to avoid slag inclusions and to get better penetration. For the 2nd and subsequent layers, remove the slag of preceding beads and avoid weaving.
- (4) In one-side welding, welding parameter should carefully be selected to prevent welding defects such as hot cracking.
- (5) In horizontal fillet welding of primer-coated plates, porosity defects such as pit and gas hole are apt to occur; therefore, the selection of proper wires and welding parameters suitable for welding primer-coated plates are essential. Figure 1 shows the relationship between welding speed and the number of pits occurred in the weld metal. Figure 2 shows proper welding speeds related to fillet leg lengths.

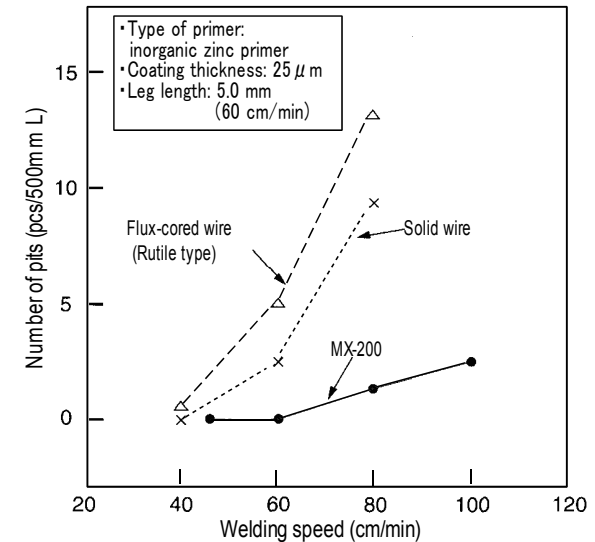

Fig. 1 Porosity resistance to primer

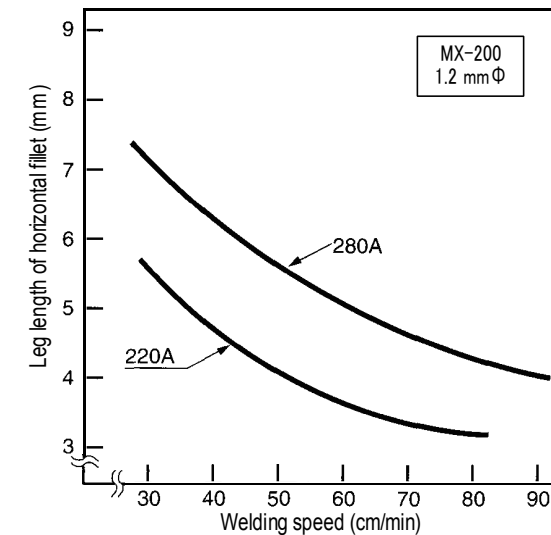

Fig. 2 Horizontal fillet leg length vs. welding speed

For Mild Steel and 490MPa High Tensile Strength Steel

■ Tips for better welding results in Gas Metal Arc Welding

- (1) Use a CO₂ shielding gas corresponding to ANSI/AWS A5.32/A5.32M SG-C or an equivalent CO₂ gas purified for welding.
- (2) Control the mixing ratio of Ar and CO₂ in an Ar-CO₂ admixture shielding gas because fluctuation of the mixing ratio affects the usability of a solid wire.
- (3) Adjust the shielding gas flow rate in the 20 to 25 l/min range.
- (4) Use a wind screen in welding in a windy area because a strong wind causes blowholes.
- (5) Use a proper ventilation system at where general ventilation is inadequate.
- (6) Keep the tip-to-work distance at around 15 mm with welding currents less than 250A and at around 20 to 25 mm with welding currents over 250A.
- (7) The use of an excessively low arc voltage may generate a large sound in spray arc welding with an Ar-CO₂ shielding gas. In such a case increase the arc voltage to prevent blowholes.
- (8) Torch angle, welding speed, wire diameter, and welding current markedly affect bead appearance and penetration; therefore, adjust such welding parameters according to the application.

■ Tips for better welding results in Gas Tungsten Arc Welding

- (1) Welding power source:
Use the DC-EN connection with the constant current or drooping characteristic DC power source in general applications.
- (2) Shielding gas:
Use an argon gas with a high purity equivalent to that of JIS K1105, in order to prevent pits and blowholes in the weld metal and decrease consumption of the tip of a tungsten electrode. When the length of the Ar gas piping is long, use metal pipes or Teflon tubes to prevent porosity in the weld metal, because moisture can permeates into the Ar gas through the wall of a rubber hose and thereby causes porosity. Adjust the shielding gas flow rate in the 12-18 l/min range.
- (3) Tungsten electrode:
A 1-2% thoriated tungsten electrode is suitable. The tip of the tungsten electrode must be kept sharp in order to maintain the arc stable.
- (4) Tungsten electrode extension length and arc length:
In order to keep the shielding of molten weld pool in good condition, the extension of a tungsten electrode from shielding nozzle should be approx. 5 mm. Maintain the arc length at 1-3 mm. The use of an excessively long arc length can deteriorate the shielding effect and causes undercut.
- (5) Cleaning of welding groove:
Because the quality of gas tungsten arc welds is markedly affected by dirt on groove surfaces, scale, rust, water and oil must be removed before welding because they can cause pits, blowholes and unstable arcs.
- (6) Wind protection and ventilation:
Use a wind screen in a windy site to maintain the shielding gas in good condition. Use an appropriate ventilation system where welding is carried out in a confined area to prevent welders from oxygen deficiency.

■ Tips for better welding results in Submerged Arc Welding

- (1) Accuracy of groove sizes:
The accuracy of root gap and groove angle affects the quality of welds much more than with other welding processes; where the accuracy is poor, burn-through, lack of penetration, excessive or insufficient reinforcement can occur.
- (2) Surface of groove:
Rust and oil in the groove must be removed before welding to prevent pits and blowholes.
- (3) Distribution and circulation of flux:
Where a flux is supplied excessively on the base plate, the bead appearance becomes irregular particularly in use of melted fluxes. In case where a flux is used repetitively by means of a circulation system, the flux can be contaminated with scale and dust and its grain size distribution can be varied; therefore, add new flux occasionally to maintain good performances of the flux.
- (4) Grain size of flux:
Several grain sizes are available for a certain melted flux. The most proper size depends on welding currents to be used. The use of high currents with a coarse grain size flux can deteriorates bead appearance; in contrast, the use of low currents with a fine grain size flux can cause pock marks because of poor degassing.
- (5) Welding condition and penetration:
Submerged arc welding can use a wide range of parameters such as wire diameter, welding current, arc voltage and welding speed; however, erroneous setting of the parameter causes burn-through, and insufficient or excessive penetration and reinforcement. The bead shape can be affected by the travel angle of a wire; that is, where the wire is leaned to the direction of welding (backhand welding), the bead shape becomes narrower with comparatively deep penetration. In contrast, where the wire is leaned to the opposite direction of welding (forehand welding), the bead shape becomes wider with shallower penetration.

■ A guide for selecting welding consumables for pipe welding

1. Welding consumables for straight pipe seam welding

API pipe grade	Flux/Wire	Application
X42, X46	MF-38/US-36 or US-49	General applications
X52, X56 X60	MF-100N/US-36 or US-40	Low temperature applications

2. Welding consumables for spiral pipe welding

API pipe grade	Flux/Wire	Application
X42, X46	G-50/US-36 or US-40	General applications
X52, X56	G-60/US-36 or US-40	High speed welding
X60, X65 X70	MF-100N/US-36 or US-40	Low temperature applications

B-14



Ilmenite type covered electrode for mild steel

Classification: ASME / AWS A5.1 E6019
EN ISO 2560-A-E 35 2 RA
JIS Z3211 D4301

Features : •Suitable for butt and fillet welding of thin and middle-thick plates (up to 20mm)
▪Excellent usability

Redrying conditions: 70~100°Cx0.5~1h

Welding Positions:

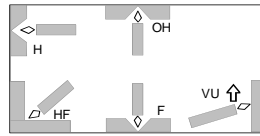

Chemical composition of all-weld metal (%) as per AWS

	C	Si	Mn	P	S
Example	0.10	0.10	0.43	0.015	0.007
Guaranty	0.05~0.13	0.05~0.25	0.25~0.65	≤0.030	≤0.025

Mechanical properties of all-weld metal as per AWS

	YP (MPa)	TS (MPa)	EI (%)	IV (J)
Example	410	460	32	-18°C: 82
Guaranty	≥330	≥410	≥22	-18°C≥27

Recommended welding parameters

	2.6mm	3.2mm	4.0mm	5.0mm	6.0mm
Dia.	2.6mm	3.2mm	4.0mm	5.0mm	6.0mm
F, HF, H	55~90A	85~140A	130~190A	180~260A	240~310A
VU, OH	45~75A	60~120A	100~160A	135~210A	-

Polarity

Example	AC
Guaranty	AC, DC-EP, DC-EN

Approvals

AB	LR	NV	BV	NK	Others
3	3m	3	3	KMW3	CR, GL

Packages

Dia. (mm)	Length (mm)	Weight per pack(kg)	Weight per carton(kg)	Weight per piece(g)
2.6	350	5	20	20
3.2	400	5	20	35
4.0	450	5	20	62
5.0	450	5	20	94
6.0	450	5	20	141

RB-26



High titania type covered electrode for mild steel

Classification : ASME / AWS A 5.1 E6013
EN ISO 2560-A-E 35 0 R
JIS Z3211 D4313

Features : •Suitable for butt and fillet welding of thin plates
▪Excellent usability in all positions including vertical downward

Redrying Conditions: 70~100°Cx0.5~1h

Welding Positions:

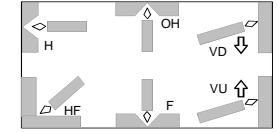

Chemical composition of all-weld metal (%) as per AWS

	C	Si	Mn	P	S
Example	0.08	0.30	0.37	0.012	0.010
Guaranty	0.05~0.12	0.15~0.45	0.25~0.65	≤0.030	≤0.025

Mechanical properties of all-weld metal as per AWS

	YP (MPa)	TS (MPa)	EI (%)
Example	450	510	25
Guaranty	≥330	≥410	≥17

Recommended welding parameters

	2.0mm	2.6mm	3.2mm	4.0mm	5.0mm
Dia.	2.0mm	2.6mm	3.2mm	4.0mm	5.0mm
F, HF, H, VD	30~65A	45~95A	60~125A	105~170A	150~220A
VU, OH	30~65A	45~95A	60~125A	100~150A	125~190A

Polarity

Example	AC
Guaranty	AC, DC-EP, DC-EN

Approvals

AB	LR	NK
2	2m	KMW2

Packages

Dia. (mm)	Length (mm)	Weight per pack (kg)	Weight per carton (kg)	Weight per piece (g)
2.0	300	2	20	10
2.6	350	5	20	19
3.2	350	5	20	29
4.0	400	5	20	53
5.0	400	5	20	81

LB-52



Low hydrogen type covered electrode for mild steel and 490MPa high tensile strength steel

Classification: ASME / AWS A5.1 E7016
EN ISO 2560-A-E 42 3 B
JIS Z3212 D5016

Features: •Suitable for butt and fillet welding of heavy structures
•Excellent mechanical properties

Redrying Conditions: 300~350°Cx0.5~1 h

■ **Chemical composition of all-weld metal (%) as per AWS**

	C	Si	Mn	P	S
Example	0.08	0.60	0.94	0.011	0.006
Guaranty	0.05~0.10	≤0.75	≤1.60	≤0.020	≤0.020

■ **Mechanical properties of all-weld metal as per AWS**

	0.2%OS (MPa)	TS (MPa)	EI (%)	IV (J)	PWHT (°Cxh)
Example	500	570	32	-29°C:120	AW
	420	520	33	-29°C:150	620x1
Guaranty	≥400	≥480	≥22	-29°C≥27	AW
	≥350	≥460	≥25	-29°C≥27	620±15x1

■ **Recommended welding parameters**

	Dia.	2.6mm	3.2mm	4.0mm	5.0mm	6.0mm
F, HF, H	55~85A	90~130A	130~180A	180~240A	210~310A	
VU, OH	50~80A	80~120A	110~170A	150~200A	-	

■ **Polarity**

Example	AC
Guaranty	AC, DC-EP

■ **Approvals**

AB	LR	NV	BV	NK
3H10,3Y,3Y400	3m,3Ym(H15)	3YH10	3.3Y	KMW53H10

■ **Packages**

Dia. (mm)	Length (mm)	Weight per pack (kg)	Weight per carton (kg)	Weight per piece (g)
2.6	350	5	20	20
3.2	350	5	20	31
4.0	400	5	20	54
5.0	450	5	20	97
6.0	450	5	20	137

Welding Positions

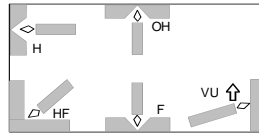

LB-52U



Low hydrogen type covered electrode for mild steel and 490MPa high tensile strength steel

Classification: ASME / AWS A5.1 E7016
EN ISO 2560-A-E 42 2 B
JIS Z3211 D4316

Features : •Suitable for one side welding of pipes
•Extremely good arc stability in one side welding with relatively low current

Redrying Conditions: 300~350°Cx0.5~1 h

■ **Chemical composition of all-weld metal (%) as per AWS**

	C	Si	Mn	P	S
Example	0.08	0.64	0.86	0.012	0.008
Guaranty	0.05~0.10	≤0.75	≤1.60	≤0.020	≤0.020

■ **Mechanical properties of all-weld metal as per AWS**

	0.2%OS (MPa)	TS (MPa)	EI (%)	IV (J)
Example	480	560	31	-29°C: 80
Guaranty	≥400	≥480	≥22	-29°C≥27

■ **Recommended welding parameters**

	Dia.	2.6mm	3.2mm	4.0mm	5.0mm
F, HF, H	60~90A	90~130A	130~180A	180~240A	
VU, OH	50~80A	80~120A	110~170A	150~200A	
Root pass	30~80A	60~110A	90~140A	130~180A	

Root pass: DC-EN is also suitable.

■ **Polarity**

Example	AC
Guaranty	AC, DC-EP

■ **Approvals**

AB	LR	NV	BV	NK	Others
3H10,3Y	3m,3Ym(H15)	3YH10	3,3YHH	KMW53H10	CCS

■ **Packages**

Dia. (mm)	Length (mm)	Weight per pack (kg)	Weight per carton (kg)	Weight per piece (g)
2.6	350	5	20	20
3.2	400	5	20	35
4.0	400	5	20	53
5.0	400	5	20	82

Welding Positions

Welding Positions

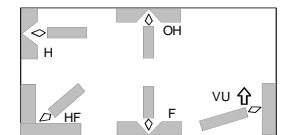

LB-52-18



Iron powder low hydrogen type covered electrode for mild steel and 490MPa high tensile strength steel

Classification: ASME / AWS A5.1 E7018
 EN ISO 2560-A-E 42 3 B
 JIS Z3212 D5016

Features : •Suitable for butt and fillet welding of heavy structure
 •Good performance by DC-EP current

Redrying Conditions: 300~350°Cx0.5~1 h

Welding Positions:

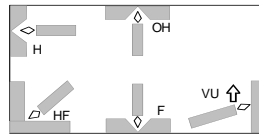

Chemical composition of all-weld metal (%) as per AWS

	C	Si	Mn	P	S
Example	0.07	0.59	0.97	0.013	0.007
Guaranty	0.05~0.10	≤0.75	≤1.60	≤0.020	≤0.020

Mechanical properties of all-weld metal as per AWS

	0.2%OS (MPa)	TS (MPa)	EI (%)	IV (J)	PWHT (°Cxh)
Example	500	560	31	-29°C:110	AW
	420	520	32	-29°C:140	620x1
Guaranty	≥400	≥480	≥22	-29°C≥27	AW
	≥350	≥460	≥25	-29°C≥27	620±15x1

Recommended welding parameters

	2.6mm	3.2mm	4.0mm	5.0mm
Dia.	2.6mm	3.2mm	4.0mm	5.0mm
F, HF, H	65~95A	90~130A	130~190A	190~250A
VU, OH	60~90A	80~120A	110~170A	165~210A

Polarity

Example	AC
Guaranty	AC, DC-EP

Approvals

AB	LR	NV	NK
3H10,3Y	3m,3Ym(H15)	3YH10	KMW53HH

Packages

Dia. (mm)	Length (mm)	Weight per pack(kg)	Weight per carton(kg)	Weight per piece(g)
2.6	350	5	20	24
3.2	400	5	20	41
4.0	450	5	20	69
5.0	450	5	20	106

LB-52RC



Low hydrogen type covered electrode for HIC resistant steel

Classification: ASME / AWS A5.1 E7016
JIS Z3211 E4916

Features: •Suitable for butt and fillet welding of heavy structures
•Excellent mechanical properties

Redrying Conditions: 300~350°Cx0.5~1 h

Welding Positions

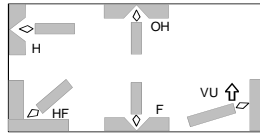

Chemical composition of all-weld metal (%) as per AWS

	C	Si	Mn	P	S
Example	0.08	0.51	1.11	0.008	0.002
Guaranty	≤0.12	≤0.60	0.50~1.60	≤0.014	≤0.006

Mechanical properties of all-weld metal as per AWS

	0.2%OS (MPa)	TS (MPa)	EI (%)	IV (J)	PWHT (°Cxh)
Example	470	550	31	-30°C:160	AW
	400	510	34	-30°C:180	620x8
Guaranty	≥400	≥490	≥23	-30°C≥34	AW
	≥285	460~580	≥20	-30°C≥34	620x8

Recommended welding parameters

	3.2mm	4.0mm	5.0mm
Dia.	3.2mm	4.0mm	5.0mm
F, HF, H	90~130A	130~180A	180~240A
VU, OH	80~120A	110~170A	150~200A

Polarity

Example	DCEP
Guaranty	DC-EP, AC

Packages

Dia. (mm)	Length (mm)	Weight per pack (kg)	Weight per carton (kg)	Weight per piece (g)
3.2	350	5	20	31
4.0	400	5	20	54
5.0	450	5	20	97

KOBE-7024



Iron-powder titania type covered electrode for mild steel and 490MPa high tensile strength steel

Classification: ASME / AWS A5.1 E7024

Features: •Suitable for flat and horizontal fillet welding
•Good welding usability in manual and gravity welding

Redrying Conditions: 70~100°Cx0.5~1h

Welding Positions:

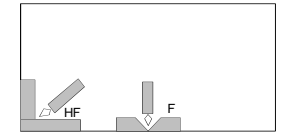

Chemical composition of all-weld metal (%) as per AWS

	C	Si	Mn	P	S
Example	0.09	0.35	0.63	0.017	0.008
Guaranty	≤0.15	≤0.90	≤1.25	≤0.030	≤0.030

Mechanical properties of all-weld metal as per AWS

	0.2%OS (MPa)	TS (MPa)	EI (%)	IV (J)
Example	470	540	27	0°C: 55
Guaranty	≥400	≥490	≥17	-

Recommended welding parameters

	4.0mm	5.0mm
Dia.	4.0mm	5.0mm
F, HF	170~210A	220~260A

Polarity

Example	DCEP
Guaranty	DC-EP, AC, DC-EN

Packages

Dia. (mm)	Length (mm)	Weight per pack(kg)	Weight per carton(kg)	Weight per piece(g)
4.0	450	5	20	101
5.0	450	5	20	147

KOBE-6010



High cellulose type covered electrode for pipe welding (up to API-X52)

Classification: ASME / AWS A5.1 E6010
EN ISO 2560-A-E 35 0 C

Features: •Suitable for butt welding of pipes
•Excellent usability in vertical downward welding

Welding Positions:

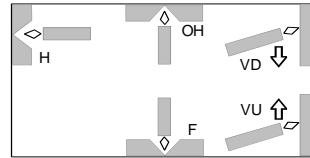

Chemical composition of all-weld metal (%) as per AWS

	C	Si	Mn	P	S
Example	0.12	0.15	0.51	0.009	0.008
Guaranty	0.05~0.20	≤0.40	0.30~0.80	≤0.030	≤0.025

Mechanical properties of all-weld metal as per AWS

	0.2%OS (MPa)	TS (MPa)	EI (%)	IV (J)
Example	430	510	27	-29°C: 63
Guaranty	≥330	≥410	≥22	-29°C ≥27

Recommended welding parameters

	2.4mm	3.2mm	4.0mm	4.8mm
Dia.	2.4mm	3.2mm	4.0mm	4.8mm
F, H	40~75A	70~130A	90~180A	140~225A
VD	40~75A	70~130A	90~180A	140~225A
VU, OH	40~75A	70~130A	90~180A	140~225A

Polarity

Example	DC-EP
Guaranty	DC-EP

Packages

Dia. (mm)	Length (mm)	Weight per pack(kg)	Weight per carton(kg)	Weight per piece(g)
2.4	300	2	20	13
3.2	350	5	20	27
4.0	350	5	20	40
4.8	350	5	20	58

KOBE-7010S



High cellulose type covered electrode for pipe welding (API-X52 to X60)

Classification: ASME / AWS A5.5 E7010-P1
EN ISO 2560-A-E 42 0 C

Features : •Suitable for butt welding of pipes
•Excellent usability in vertical downward welding

Welding Positions:

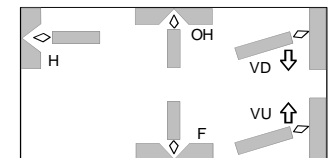

Chemical composition of all-weld metal (%) as per AWS

	C	Si	Mn	P	S
Example	0.14	0.10	1.01	0.012	0.007
Guaranty	≤0.20	≤0.60	≤1.20	≤0.03	≤0.03

Mechanical properties of all-weld metal as per AWS

	0.2%OS (MPa)	TS (MPa)	EI (%)	IV (J)
Example	470	570	30	-29°C: 61
Guaranty	≥410	≥480	≥22	-29°C ≥27

Recommended welding parameters

	2.4mm	3.2mm	4.0mm	4.8mm
Dia.	2.4mm	3.2mm	4.0mm	4.8mm
F, H	40~70A	60~120A	90~170A	130~210A
VD	40~70A	70~120A	100~170A	150~210A
VU, OH	40~70A	60~120A	80~160A	120~200A

Polarity

Example	DC-EP
Guaranty	DC-EP

Packages

Dia. (mm)	Length (mm)	Weight per pack(kg)	Weight per carton(kg)	Weight per piece(g)
2.4	300	2	20	13
3.2	350	5	20	26
4.0	350	5	20	40
4.8	350	5	20	58

KOBE-8010S



High cellulose type covered electrode for pipe welding (API-X60 to X70)

Classification: ASME / AWS A5.5 E8010-P1
EN ISO 2560-A-E 36 0 Z C

Features: •Suitable for butt welding of pipes
•Excellent usability in vertical downward welding

Welding Positions:

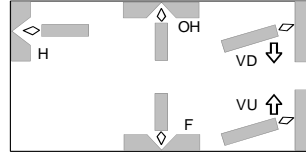

Chemical composition of all-weld metal (%) as per AWS

	C	Si	Mn	P	S	Mo
Example	0.15	0.12	1.05	0.012	0.006	0.27
Guaranty	≤0.20	≤0.60	≤1.20	≤0.03	≤0.03	≤0.50

Mechanical properties of all-weld metal as per AWS

	0.2%OS (MPa)	TS (MPa)	EI (%)	IV (J)
Example	520	620	28	-29°C: 54
Guaranty	≥460	≥550	≥19	-29°C ≥27

Recommended welding parameters

	3.2mm	4.0mm	4.8mm
Dia.	3.2mm	4.0mm	4.8mm
F, H	60~120A	90~170A	130~210A
VD	70~120A	100~170A	150~210A
VU, OH	60~120A	80~160A	120~200A

Polarity

Example	DC-EP
Guaranty	DC-EP

Packages

Dia. (mm)	Length (mm)	Weight per pack(kg)	Weight per carton(kg)	Weight per piece(g)
3.2	350	5	20	26
4.0	350	5	20	40
4.8	350	5	20	58

LB-78VS



Extra low hydrogen type covered electrode for pipe welding (up to API-X60)

Classification: ASME / AWS A5.1 E7048
EN ISO 2560-A-E 42 2 B

Features : •Suitable for butt welding of pipes
•Excellent usability in vertical downward welding
•Good mechanical properties

Redrying Conditions: 350~400°Cx1 h

Welding Positions:

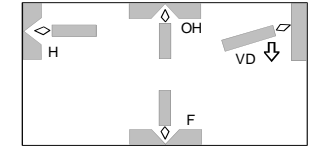

Chemical composition of all-weld metal (%) as per AWS

	C	Si	Mn	P	S
Example	0.06	0.56	1.18	0.012	0.005
Guaranty	0.05~0.10	≤0.90	≤1.60	≤0.020	≤0.020

Mechanical properties of all-weld metal as per AWS

	0.2%OS (MPa)	TS (MPa)	EI (%)	IV (J)
Example	490	580	30	-29°C:100
Guaranty	≥400	≥480	≥22	-29°C ≥27

Recommended welding parameters

	3.2mm	4.0mm
Dia. (mm)	3.2mm	4.0mm
F, VD, H	80~140A	130~210A
OH	80~120A	110~160A

Polarity

Example	AC
Guaranty	AC, DC-EP

Packages

Dia. (mm)	Length (mm)	Weight per pack(kg)	Weight per carton(kg)	Weight per piece(g)
3.2	350	5	20	33
4.0	400	5	20	56

LB-88VS



Extra low hydrogen type covered electrode for pipe welding (API-X60 to X70)

Classification: ASME / AWS A5.5 E8018-G
EN ISO 2560-A-E 46 2 Z B

Features : •Suitable for butt welding of pipes
▪Excellent usability in vertical downward welding
▪Good mechanical properties

Redrying Conditions: 350~400°Cx1 h

Welding Positions:

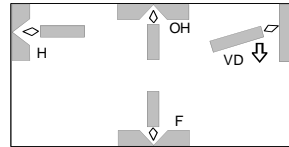

Chemical composition of all-weld metal (%) as per AWS

	C	Si	Mn	P	S	Ni	Mo
Example	0.06	0.55	1.20	0.012	0.006	0.53	0.12
Guaranty	0.05~0.10	0.30~0.75	1.00~1.40	≤0.020	≤0.020	0.40~0.80	0.05~0.30

Mechanical properties of all-weld metal as per AWS

	0.2%OS (MPa)	TS (MPa)	EI (%)	IV (J)
Example	510	620	30	-18°C:120
Guaranty	≥460	≥550	≥19	-

Recommended welding parameters

	3.2mm	4.0mm	4.5mm
Dia. (mm)	3.2mm	4.0mm	4.5mm
F, VD, H	80~140A	130~200A	160~250A
OH	80~120A	110~160A	130~190A

Polarity

Example	AC
Guaranty	AC, DC-EP

Packages

Dia. (mm)	Length (mm)	Weight per pack(kg)	Weight per carton(kg)	Weight per piece(g)
3.2	350	5	20	31
4.0	400	5	20	56
4.5	400	5	20	68

LB-98VS



Extra low hydrogen type covered electrode for pipe welding (API-X80)

Classification: ASME / AWS A5.5 E9018-G
EN ISO 2560-A-E 50 2 Z B

Features : •Suitable for butt welding of pipes
▪Excellent usability in vertical downward welding
▪Good mechanical properties

Redrying Conditions: 350~400°Cx1 h

Welding Positions:

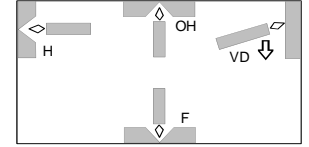

Chemical composition of all-weld metal (%) as per AWS

	C	Si	Mn	P	S	Ni	Mo
Example	0.06	0.61	1.27	0.013	0.004	1.17	0.18
Guaranty	0.05~0.10	0.30~0.75	1.00~1.50	≤0.020	≤0.020	0.90~1.40	0.10~0.40

Mechanical properties of all-weld metal as per AWS

	0.2%OS (MPa)	TS (MPa)	EI (%)	IV (J)
Example	560	660	30	-18°C:130
Guaranty	≥530	≥620	≥17	-

Recommended welding parameters

	3.2mm	4.0mm	4.5mm
Dia. (mm)	3.2mm	4.0mm	4.5mm
F, VD, H	80~140A	130~200A	160~250A
OH	80~120A	110~160A	130~190A

Polarity

Example	AC
Guaranty	AC, DC-EP

Packages

Dia. (mm)	Length (mm)	Weight per pack(kg)	Weigh per carton(kg)	Weight per piece(g)
3.2	350	5	20	31
4.0	400	5	20	56
4.5	400	5	20	67

Trade designation	ASME AWS class.	Type of covering	Pol.	Features	WP	Chemical composition of all-weld metal (%)					Mechanical properties of all-weld metal					
						C	Si	Mn	P	S	YP (MPa)	TS (MPa)	EI (%)	IV (J)		
B-10	A5.1 E6019	Ilmenite	AC DC-EP DC-EN	<ul style="list-style-type: none"> Suitable for butt and fillet welding of thin and thick plates (up to 20mm) Better usability RC: 70~100°Cx0.5~1h 	F HF H VU OH	Ex	0.10	0.09	0.39	0.016	0.008	Ex	400	450	30	-18°C: 68
						Gt	0.05~0.13	0.05~0.25	0.25~0.65	≤0.030	≤0.025	Gt	≥330	≥410	≥22	-18°C: ≥27
B-17	A5.1 E6019	Ilmenite	AC DC-EP DC-EN	<ul style="list-style-type: none"> Suitable for butt and fillet welding of thin and thick plate (up to 20mm) Good mechanical properties RC: 70~100°Cx0.5~1h 	F HF H VU OH	Ex	0.09	0.08	0.60	0.012	0.006	Ex	420	470	31	-18°C: 80
						Gt	0.05~0.13	0.05~0.25	0.50~0.90	≤0.030	≤0.025	Gt	≥330	≥410	≥22	-18°C: ≥27
Z-44	A5.1 E6013	Lime titania	AC DC-EP DC-EN	<ul style="list-style-type: none"> Typical lime titania type electrode RC: 70~100°Cx0.5~1h 	F HF H VU OH	Ex	0.08	0.14	0.34	0.014	0.009	Ex	410	460	32	0°C: 110
						Gt	≤0.12	0.05~0.45	0.20~0.60	≤0.030	≤0.025	Gt	≥330	≥410	≥17	-
B-33	A5.1 E6013	High titania	AC DC-EP DC-EN	<ul style="list-style-type: none"> Excellent usability in the flat and horizontal positions RC: 70~100°Cx0.5~1h 	F HF H VU OH	Ex	0.08	0.30	0.33	0.013	0.009	Ex	430	480	25	-
						Gt	0.05~0.12	0.20~0.50	0.10~0.65	≤0.030	≤0.025	Gt	≥330	≥410	≥17	-

Note: Welding tests are as per AWS. Ex: Example (polarity: AC);

Gt: Guaranty (polarity: as specified above)

Approvals

B-17	AB, LR, NV, BV, NK, GL, CR
Z-44	AB, LR, NV, NK

Diameter and Length (mm)

Dia.	2.0	2.6	3.2	4.0	5.0	6.0
B-10	-	350	350	400	400	450
B-17	-	350	350	400	400	450
Z-44	300	350	350	450	450	450
B-33	300	350	350	400	400	450

Trade designation	ASME AWS class.	Type of covering	Pol.	Features	WP	Chemical composition of all-weld metal (%)							Mechanical properties of all-weld metal					
						C	Si	Mn	P	S	Mo	Yield strength (MPa)	Tensile strength (MPa)	Impact energy (J)	Charpy transition temperature (°C)	Preheat (°C)		
LB-26	A5.1 E7016	Low hydrogen	AC DC-EP	<ul style="list-style-type: none"> Low hydrogen type containing iron powder RC: 300~350°C x0.5~1h 	F	Ex	0.08	0.50	0.97	0.013	0.007	-	Ex	480	550	33	-29°C:100	AW
					HF	Gt	0.05~0.10	≤0.75	≤1.60	≤0.020	≤0.020	-	Gt	410	500	34	-29°C:130	620x1
LB-52A	A5.1 E7016	Low hydrogen	AC DC-EP	<ul style="list-style-type: none"> Better impact value RC: 350~400°Cx1h 	F	Ex	0.08	0.57	1.12	0.012	0.005	-	Ex	500	580	31	-29°C:120	AW
					HF	Gt	0.05~0.10	≤0.75	≤1.60	≤0.020	≤0.020	-	Gt	430	530	33	-29°C:150	620x1
LB-52T	A5.1 E7048	Low hydrogen	AC DC-EP	<ul style="list-style-type: none"> Low hydrogen type for tack welding RC: 300~350°C x0.5~1h 	H	Ex	0.08	0.47	0.94	0.012	0.007	-	Ex	450	540	32	-29°C:110	AW
					VU	Gt	0.05~0.10	≤0.90	≤1.60	≤0.020	≤0.020	-	Gt	≥400	≥480	≥22	-29°C≥27	AW
LB-57	A5.1 E7016	Low hydrogen	AC DC-EP	<ul style="list-style-type: none"> Suitable for butt and fillet welding of 520MPa high tensile steel RC: 350~400°Cx1h 	F	Ex	0.08	0.64	0.85	0.011	0.006	0.17	Ex	530	610	31	-29°C:100	AW
					HF	Gt	0.05~0.10	≤0.75	≤1.60	≤0.020	≤0.020	≤0.30	Gt	470	540	32	-29°C:130	620x10
LB-76	A5.5 E7016-G	Low hydrogen	AC DC-EP	<ul style="list-style-type: none"> Suitable for butt and fillet welding of 520MPa high tensile steel RC: 300~350°C x0.5~1h 	H	Ex	0.08	0.58	1.30	0.013	0.007	-	Ex	510	600	29	-29°C:110	AW
					VU	Gt	0.05~0.10	0.30~0.75	1.00~1.50	≤0.020	≤0.020	-	Gt	≥390	≥480	≥25	-	AW

Note: Welding tests are as per AWS. Ex: Example (polarity: AC),

Gt: Guaranty (polarity: as specified above)

■ Approvals

LB-26	AB, LR, NV, BV, NK, CR
LB-52A	NK
LB-52T	AB, LR, NV, BV, NK, CR

■ Diameter and Length (mm)

Dia.	2.6	3.2	4.0	5.0	6.0
LB-26	350	350	400	450	450
LB-52A	-	350	400	450	450
LB-52T	-	350	400	450	-
LB-57	350	350	400	450	450
LB-76	-	350	400	450	450

Trade designation	ASME AWS class.	Type of covering	Pol.	Features	WP	Chemical		composition of all-weld metal (%)				Mechanical properties of all-weld metal				
						C	Si	Mn	P	S	YP (MPa)	TS (MPa)	EI (%)	IV (J)		
LT-B50	-	Lime titania	AC DC-EP DC-EN	▪Suitable for flat and horizontal fillet welding ▪RC: 70~100°Cx0.5~1h	F HF	Ex	0.07	0.39	0.94	0.017	0.009	Ex	480	530	29	0°C: 74
						Gt	≤0.10	0.10~0.70	0.60~1.25	≤0.030	≤0.025	Gt	≥390	≥490	≥20	0°C≥47
LT-B52A	A5.1 E7018	Low hydrogen	AC DC-EP	▪Suitable for flat and horizontal fillet welding ▪Iron powder low hydrogen type ▪RC: 300~350°C x0.5~1h	F HF	Ex	0.07	0.35	1.03	0.014	0.008	Ex	480	550	30	-29°C: 75
						Gt	≤0.11	≤0.75	≤1.60	≤0.025	≤0.025	Gt	≥400	≥480	≥22	-29°C≥27

Note: Welding tests are as per AWS. Ex: Example (polarity: AC),

Gt: Guaranty (polarity: as specified above)

Approvals

LT-B50	AB, LR, NV, BV, NK, CR, GL
LT-B52A	AB, LR, NV, BV, NK

Diameter and length (mm)

Dia.	4.0	4.5	5.0	5.5	6.0	6.4	7.0	8.0
LT-B50	450	450	450	450	450	450	450	450
	-	550	550	550	550	550	550	550
	700	700	700	700	700	700	700	
	-	900	900	900	900	900		
LT-B52A	450	-	550	-	550	550	550	450
	-	-	700	-	700	700	700	550
	-	-	-	-	-	-	-	700
	-	-	-	-	-	-	-	900

DW-100



Rutile type flux cored wire for mild steel and 490MPa high tensile strength steel

Classification: ASME / AWS A5.20 E71T-1C
EN ISO 17632-A - T 42 0 P C 1 H10
JIS Z3313 YFW-C50DR

Features: • Suitable for butt and fillet welding in all positions including vertical downward
• Soft and stable arc, less fume and spattering, smooth bead appearance, and good slag removal

Shielding gas: CO₂
Polarity: DC-EP

Welding positions:

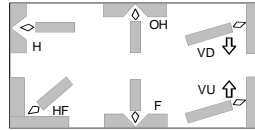

Chemical composition of all-weld metal (%) as per AWS

	C	Si	Mn	P	S
Example	0.05	0.45	1.35	0.013	0.009
Guaranty	≤0.12	≤0.90	≤1.75	≤0.03	≤0.03

Mechanical properties of all-weld metal as per AWS

	0.2%OS (MPa)	TS (MPa)	EI (%)	IV (J)
Example	510	570	30	-18°C: 85
Guaranty	≥400	≥490	≥22	-18°C ≥27

Recommended welding parameters

	1.2mm	1.4mm	1.6mm
Dia.	1.2mm	1.4mm	1.6mm
F	120~300A	150~400A	180~450A
HF	120~300A	150~350A	180~400A
H	120~280A	150~320A	180~350A
VU, OH	120~260A	150~270A	180~280A
VD	200~300A	220~300A	250~300A

Approvals

AB	LR	NV	BV	NK	Others
2SA, 2Y400SA(H10)	2S,2YS(H10) 2M,2YM(H10)	II YMS(H10)	SA2M HH, SA2YM HH	KSW52Y40G (C)H10	GL, CCS, CR, KR

Packages

Dia. (mm)	Type	Weight (kg)	Dia. (mm)	Type	Weight (kg)	Dia. (mm)	Type	Weight
1.2	Spool	12.5	1.4	Spool	12.5	1.6	Spool	12.5
	Spool	15		Spool	15		Spool	20
	Spool	20		Spool	20		Pack	350
	Pack	250		Pack	250			
					Pack		350	

DW-100E



Rutile type flux cored wire for mild steel and 490MPa high tensile strength steel

Classification: ASME / AWS A5.20 E71T-9C
EN ISO 17632-A - T 42 2 P C 1 H10
JIS Z3313 YFW-C502R

Features: • Suitable for butt and fillet welding in all positions
• Excellent impact value at low temperatures down to -29°C

Shielding gas: CO₂
Polarity: DC-EP

Welding positions:

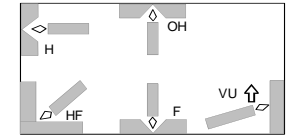

Chemical composition of all-weld metal (%) as per AWS (shielding gas: CO₂)

	C	Si	Mn	P	S	Ni
Example	0.05	0.43	1.28	0.013	0.008	0.38
Guaranty	≤0.12	≤0.90	≤1.75	≤0.03	≤0.03	≤0.50

Mechanical properties of all-weld metal as per AWS (Shielding gas: CO₂)

	0.2%OS (MPa)	TS (MPa)	EI (%)	IV (J)
Example	510	570	29	-29°C: 100
Guaranty	≥400	≥480	≥22	-29°C ≥27

Recommended welding parameters

	1.2mm	1.4mm
Dia.	1.2mm	1.4mm
F	120~300A	150~400A
HF	120~300A	150~350A
H	120~280A	150~320A
VU, OH	120~250A	150~250A

Approvals

AB	LR	NV	BV	NK	Others
3SA, 3Y400SA(H10)	3S,3YS(H10)	III YMS	SA3, 3YM	KSW53G	GL, CCS

Packages

Dia. (mm)	Type	Weight (kg)	Dia. (mm)	Type	Weight (kg)
1.2	Spool	12.5	1.4	Spool	12.5
	Spool	15		Spool	15
	Spool	20			

DW-A50



Rutile type flux cored wire for mild steel and 490MPa high tensile strength steel

Classification: ASME / AWS A5.20 E71T-1M
EN ISO 17632-A - T 42 2 P M 1 H5
JIS Z3313 YFW-A50DR

Features : •Suitable for butt and fillet welding in all position including vertical downward
•Excellent usability with soft and stable arc, less fume and spattering, good bead appearance and smooth slag removal

Shielding gas: Ar-CO₂ mixture
Polarity: DC-EP

Welding positions:

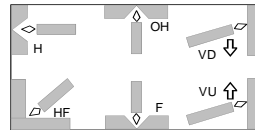

Chemical composition of all-weld metal (%) as per AWS

	C	Si	Mn	P	S
Example	0.05	0.48	1.22	0.013	0.009
Guaranty	≤0.12	≤0.90	≤1.75	≤0.03	≤0.03

Mechanical properties of all-weld metal as per AWS

	0.2%OS (MPa)	TS (MPa)	EI (%)	IV (J)
Example	510	570	30	-18°C: 110
Guaranty	≥400	≥490	≥22	-18°C ≥27

Recommended welding parameters

	1.2mm	1.6mm		1.2mm	1.6mm
Dia.	1.2mm	1.6mm	Dia.	1.2mm	1.6mm
F	120~300A	180~450A	VU, OH	120~260A	180~280A
HF	120~300A	180~400A	VD	200~300A	250~300A
H	120~280A	180~350A			

Approvals

AB	LR	NV	BV	NK	Others
3SA,3YSA(H5)	3S,3YS(H5)	III YMS(H5),MG	SA3YM HHH	KSW52G(M2)	GL, TÜV, U(ic), DB

Packages

Dia. (mm)	Type	Weight (kg)
1.2	Spool	12.5
	Spool	15
	Spool	20
	Pack	350
	Spool	12.5
1.6	Spool	12.5

DW-50



Rutile type flux cored wire for mild steel and 490MPa high tensile strength steel

Classification: ASME / AWS A5.20 E71T-1C/1M, -9C/9M
EN ISO 17632-A - T 42 2 P C/M 1 H5

Features : •Suitable for butt and fillet welding in all positions including vertical downward
•Excellent usability with soft and stable arc, less fume and spattering, good bead appearance and smooth slag removal
•Applicable for ship class E-grade plates

Shielding gas: CO₂ or Ar-CO₂ mixture
Polarity: DC-EP

Welding positions:

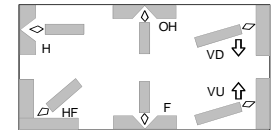

Chemical composition of all-weld metal (%) as per AWS (Shielding gas: CO₂)

	C	Si	Mn	P	S
Example	0.04	0.67	1.29	0.011	0.008
Guaranty	≤0.12	≤0.90	≤1.75	≤0.03	≤0.03

Mechanical properties of all-weld metal as per AWS (Shielding gas: CO₂)

	0.2%OS (MPa)	TS (MPa)	EI (%)	IV (J)
Example	510	582	31	-29°C: 108
Guaranty	≥400	≥490	≥22	-29°C ≥27

Recommended welding parameters

	1.2mm	1.6mm
Dia.	1.2mm	1.6mm
F	120~300A	180~450A
HF	120~300A	180~400A
H	120~280A	180~400A
VU, OH	120~270A	180~280A
VD	200~300A	250~300A

Approvals

AB	LR	NV	NK	Others
3SA,3YSA(H5)	3S,3YS(H5)	III YMS(H5)	KSW53G(C)	GL, CWB

Packages

Dia. (mm)	Type	Weight (kg)	Dia. (mm)	Type	Weight (kg)
1.2	Spool	5	1.6	Spool	15
	Spool	15		Spool	20
	Spool	20		Pack	350
	Pack	250			

MX-200



Metal type flux cored wire for mild steel and 490MPa high tensile strength steel

Classification: ASME / AWS A5.20 E70T-1C
EN ISO 17632-A - T 42 0 R C 3 H5
JIS Z3313 YFW-C50DM

Features : •Suitable for flat and horizontal fillet welding
•Excellent porosity resistibility to inorganic zinc primer

Shielding gas: CO₂

Polarity: DC-EP

Welding positions:

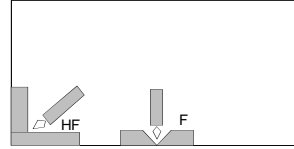

■ **Chemical composition of all-weld metal (%) as per AWS**

	C	Si	Mn	P	S
Example	0.06	0.50	1.40	0.013	0.009
Guaranty	≤0.12	≤0.90	≤1.75	≤0.03	≤0.03

■ **Mechanical properties of all-weld metal as per AWS**

	0.2%OS (MPa)	TS (MPa)	EI (%)	IV (J)
Example	530	590	29	-18°C: 55
Guaranty	≥400	≥490	≥22	-18°C≥27

■ **Recommended welding parameters**

	1.2mm	1.4mm	1.6mm
Dia.	1.2mm	1.4mm	1.6mm
F	150~300A	170~400A	200~450A
HF	180~300A	200~350A	270~400A

■ **Approvals**

AB	LR	NV	BV	NK	Others
2SA,2Y400SA (H5)	2S,2YS(H5)	II YMS(H5)	SA2YM HHH	KSW52Y40G (C)H5	GL, CCS, CR, KR

■ **Packages**

Dia. (mm)	Type	Weight (kg)	Dia. (mm)	Type	Weight (kg)	Dia. (mm)	Type	Weight (kg)
1.2	Spool	12.5	1.4	Spool	12.5	1.6	Spool	15
	Spool	15		Spool	15		Spool	20
	Spool	20		Spool	20		Pack	350
	Pack	250	Pack	250	350			

MX-200E



Metal type flux cored wire for mild steel and 490MPa high tensile strength steel

Classification: ASME / AWS A5.20 E70T-9C
EN ISO 17632-A - T 42 3 R C 3 H5
JIS Z3313 YFW-C502M

Features : •Suitable for flat and horizontal fillet welding
•Excellent porosity resistibility to inorganic zinc primer
•Excellent impact value at low temperatures down to -29°C

Shielding gas: CO₂

Polarity: DC-EP

Welding positions:

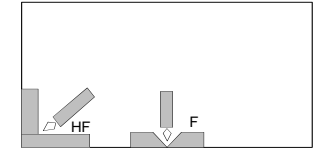

■ **Chemical composition of all-weld metal (%) as per AWS**

	C	Si	Mn	P	S
Example	0.05	0.63	1.63	0.008	0.007
Guaranty	≤0.12	≤0.90	≤1.75	≤0.03	≤0.03

■ **Mechanical properties of all-weld metal as per AWS**

	0.2%OS (MPa)	TS (MPa)	EI (%)	IV (J)
Example	540	600	30	-29°C: 70
Guaranty	≥400	≥490	≥22	-29°C≥27

■ **Recommended welding parameters**

	1.2mm	1.4mm	1.6mm
Dia.	1.2mm	1.4mm	1.6mm
F	150~300A	170~400A	200~450A
HF	180~300A	200~350A	270~400A

■ **Approvals**

AB	LR	NV	BV	NK	Others
4Y400SA (H5)	4Y40S(H5)	IVY40MS(H5)	SA4Y40M H5	KSW54Y40G (C)H5	GL

■ **Packages**

Dia. (mm)	Type	Weight (kg)	Dia. (mm)	Type	Weight (kg)
1.2	Spool	12.5	1.4	Spool	12.5
	Spool	15		Spool	15
	Spool	20		Spool	20
	Pack	250	Pack	250	200

MX-A100



Metal cored wire for mild steel and 490MPa high tensile strength steel

Classification: ASME / AWS A5.18 E70C-6M
 EN ISO 17632-A - T 42 4 M M 3 H5
 JIS Z3313 YFW-A50DM

Features : • Suitable for butt and fillet welding
 • Better arc stability and wider optimum current range for spray transfer arc with less spattering than solid wire

Shielding gas: Ar-CO₂ mixture

Polarity: DC-EP

Welding positions:

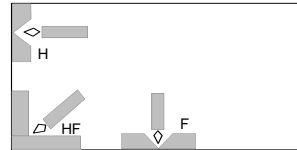

Chemical composition of all-weld metal (%) as per AWS

	C	Si	Mn	P	S
Example	0.05	0.63	1.58	0.017	0.011
Guaranty	≤0.12	≤0.90	≤1.75	≤0.03	≤0.03

Mechanical properties of all-weld metal as per AWS

	0.2%OS (MPa)	TS (MPa)	EI (%)	IV (J)
Example	450	550	33	-40°C: 71
Guaranty	≥400	≥483	≥22	-40°C ≥27

Recommended welding parameters

Dia.	1.2mm	1.4mm	1.6mm
F	150~350A	200~450A	250~500A
HF, H	150~300A	200~400A	250~450A

Approvals

LR	NV	BV	Others
3S,4Y(H5)	IVYMS(H5)	SA4YM HHH	GL, TÜV, U(ic), DB

Packages

Dia. (mm)	Type	Weight (kg)
1.2	Spool	20
	Pack	350
1.4	Spool	20
	Pack	350
1.6	Spool	20

MX-100T



Metal cored wire for mild steel and 490MPa high tensile strength steel

Classification: ASME / AWS A5.18 E70C-6C/6M
 EN ISO 17632-A - T 42 2 M C/M 1 H5
 JIS Z3313 YFW-C50DM

Features : • Suitable for butt and fillet welding in all positions for thin plates (e.g., 0.8mm)
 • Excellent arc stability in low current range (50~180A) for short circuiting welding in all positions

Shielding gas: CO₂ or Ar-CO₂ mixture

Polarity: DC-EP

Welding positions:

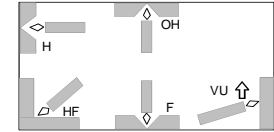

Chemical composition of all-weld metal (%) as per AWS (Shielding gas: CO₂)

	C	Si	Mn	P	S
Example	0.08	0.49	1.53	0.013	0.015
Guaranty	≤0.12	≤0.90	≤1.75	≤0.03	≤0.03

Mechanical properties of all-weld metal as per AWS (Shielding gas: CO₂)

	0.2%OS (MPa)	TS (MPa)	EI (%)	IV (J)
Example	480	560	31	-29°C: 62
Guaranty	≥400	≥490	≥22	-29°C ≥27

Recommended welding parameters

Dia.	1.2mm	1.4mm
F, HF, H	50~300A	80~400A
VU, OH	50~180A	70~180A

Approvals

AB	LR	NV	BV	Others
3SA,3YSA(H5)	3S,3YS(H5)	IIIYMS(H5)	SA3YM HHH	GL, CR, TÜV, U(ic)

Packages

Dia. (mm)	Type	Weight (kg)
1.2	Spool	20
	Pack	250
1.4	Spool	20
	Pack	250

Trade designation	ASME AWS class.	Type of cored flux	SG	Pol.	Features	WP	Chemical composition of all-weld metal (%)					Mechanical properties of all-weld metal					
							C	Si	Mn	P	S	0.2%OS (MPa)	TS (MPa)	EI (%)	IV (J)		
DW-100V	A5.20 E71T-1C	Rutile	CO ₂	DC-EP	<ul style="list-style-type: none"> •Suitable for butt and fillet welding in all positions including vertical downward •Excellent performance especially in vertical upward 	F HF H VD VU OH	Ex	0.05	0.60	1.35	0.010	0.009	Ex	490	580	30	-18°C: 50
						Gt	≤0.12	≤0.90	≤1.75	≤0.03	≤0.03	Gt	≥400	≥490	≥22	-18°C≥27	
DW-200	A5.20 E70T-1C	Rutile	CO ₂	DC-EP	<ul style="list-style-type: none"> •Suitable for flat and horizontal fillet welding •A large leg length of about 9mm in horizontal fillet 	F HF	Ex	0.06	0.48	1.50	0.012	0.010	Ex	490	560	28	-18°C: 60
						Gt	≤0.12	≤0.90	≤1.75	≤0.03	≤0.03	Gt	≥400	≥490	≥22	-18°C≥27	
DW-A51B	A5.20 E71T-5M-J	Basic	Ar-CO ₂	DC-EN	<ul style="list-style-type: none"> •Suitable for butt and fillet welding in all positions 	F HF H VU OH	Ex	0.07	0.45	1.40	0.014	0.009	Ex	480	570	30	-40°C: 95
						Gt	≤0.12	≤0.90	≤1.75	≤0.03	≤0.03	Gt	≥400	≥480	≥22	-40°C≥27	

Note: Welding tests are as per AWS. Ex: Example, Gt: Guaranty

Approvals

DW-100V	AB, LR, NV, BV, NK, GL
DW-200	AB, LR, NV, BV, NK
DW-A51B	LR, NV, BV, GL, TÜV, U(ic), DB

Diameter (mm)

DW-100V	1.2, 1.4
DW-200	1.2, 1.4
DW-A51B	1.2, 1.6

Trade designation	ASME AWS class.	Type of cored flux	SG	Pol.	Features	WP	Chemical composition of all-weld metal (%)					Mechanical properties of all-weld metal					
							C	Si	Mn	P	S	0.2%OS (MPa)	TS (MPa)	EI (%)	IV (J)		
MX-100	A5.20 E70T-1C	Metal	CO ₂	DC-EP	•Suitable for butt and fillet welding	F HF H	Ex	0.06	0.62	1.35	0.014	0.011	Ex	510	580	30	-18°C: 50
							Gt	≤0.12	≤0.90	≤1.75	≤0.03	≤0.03	Gt	≥400	≥490	≥22	-18°C≥27
MX-200H	A5.20 E70T-1C	Metal	CO ₂	DC-EP	•Suitable for horizontal fillet welding by high speed tandem method (150cm/min) •Excellent porosity resistibility to inorganic zinc primer	F HF	Ex	0.06	0.55	1.55	0.015	0.008	Ex	500	600	27	-18°C: 90
							Gt	≤0.12	≤0.90	≤1.75	≤0.03	≤0.03	Gt	≥400	≥490	≥22	-18°C≥27
MX-A200	A5.20 E70T-1M	Metal	Ar-CO ₂	DC-EP	•Suitable for flat and horizontal fillet welding •Excellent porosity resistibility to inorganic zinc primer	F HF	Ex	0.05	0.56	1.52	0.010	0.009	Ex	520	590	29	-18°C: 67
							Gt	≤0.12	≤0.90	≤1.75	≤0.03	≤0.03	Gt	≥400	≥490	≥22	-18°C≥27

Note: Welding tests are as per AWS. Ex: Example, Gt: Guaranty

■ Approvals

MX-100	AB, LR, NV, BV, NK, CR, GL
MX-200H	AB, LR, NV, BV, NK, CR, KR, CCS

■ Diameter (mm)

MX-100	1.2, 1.4, 1.6, 2.0
MX-200H	1.4, 1.6
MX-A200	1.2, 1.4, 1.6

MG-50



Solid wire for mild steel and 490MPa high tensile strength steel

Classification: ASME / AWS A5.18 ER70S-G
JIS Z3312 YGW11

Features : •Suitable for flat, horizontal and horizontal fillet welding
•Higher currents are recommended

Shielding gas: CO₂

Polarity: DC-EP

Welding positions:

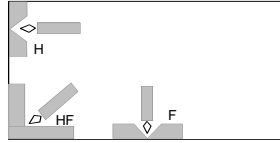

Chemical composition of wire (%) as per AWS

	C	Si	Mn	P	S	Cu	Al	Ti+Zr
Example	0.04	0.73	1.64	0.010	0.010	0.23	0.01	0.22
Guaranty	≤0.15	0.55~ 1.10	1.40~ 1.90	≤0.030	≤0.030	≤0.50	≤0.10	≤0.30

Mechanical properties of all-weld metal as per AWS

	0.2%OS (MPa)	TS (MPa)	EI (%)	IV (J)	PWHT (°Cxh)
Example	490	570	30	-18°C: 100	AW
	420	530	34	-18°C: 110	625x1
Guaranty	≥400	≥480	≥22	-18°C≥27	AW

Recommended welding parameters

Dia.	1.0mm	1.2mm	1.4mm	1.6mm
F	50~220A	100~350A	150~450A	200~550A
H	50~200A	100~300A	150~350A	200~400A

Approvals

AB	LR	NV	BV	NK	Others
3SA,3YSA	3S,3YS(H15)	ⅢYMS	SA3M,3YM	KSW53G	GL, CR, KR

Packages

Dia. (mm)	Type	Weight (kg)	Dia. (mm)	Type	Weight (kg)
1.0	Spool	20	1.4	Spool	10
1.2	Spool	10		Spool	15
	Spool	15		Spool	20
	Spool	20		Pack	250
	Pack	250	1.6	Spool	20
			20	Spool	20

MG-51T



Solid wire for mild steel and 490MPa high tensile strength steel

Classification: ASME / AWS A5.18 ER70S-6
JIS Z3312 YGW12

Features : •Suitable for butt and fillet welding in all positions
•Higher currents can be applied in vertical and overhead positions
•Suitable for pipe welding in all positions

Shielding gas: CO₂

Polarity: DC-EP

Welding positions:

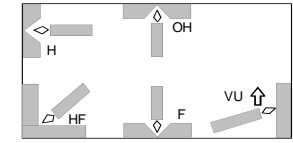

Chemical composition of wire (%) as per AWS (Shielding gas: CO₂)

	C	Si	Mn	P	S	Cu
Example	0.10	0.88	1.56	0.011	0.012	0.24
Guaranty	0.06~ 0.15	0.80~ 1.10	1.40~ 1.85	≤0.025	≤0.030	≤0.50

Mechanical properties of all-weld metal as per AWS

	0.2%OS (MPa)	TS (MPa)	EI (%)	IV (J)	Shielding gas
Example	470	560	32	-29°C: 70	CO ₂
	520	600	31	-29°C: 90	80%Ar-20%CO ₂
Guaranty	≥400	≥480	≥22	-29°C≥27	CO ₂

Recommended welding parameters

Dia.	0.9mm	1.0mm	1.2mm
F	50~200A	50~220A	80~350A
VU	50~140A	50~140A	50~160A
OH	50~120A	50~120A	50~140A

Packages

Dia. (mm)	Type	Weight (kg)	Dia. (mm)	Type	Weight (kg)
0.9	Spool	20	1.2	Spool	20
	Pack	250		Pack	250
1.0	Spool	20			

Trade designation	ASME AWS Class	SG	Pol.	Features	WP	Chemical		composition of wire (%)					Mechanical properties of all-weld metal						
						C	Si	Mn	P	S	Cu	YP (MPa)	TS (MPa)	EI (%)	IV (J)	PWHT (°C×h) & SG			
MG-50T	ER70S-G	CO ₂	DC-EP	•Suitable for butt and fillet welding in all positions •Suitable for lower currents	F HF H VU OH	Ex	0.06	0.75	1.34	0.011	0.011	0.24	Ex	460	540	31	-18°C: 100	AW	
														360	490	34	-18°C: 110		625x2
						Gt	≤0.15	0.55~1.10	1.25~1.90	≤0.030	≤0.030	≤0.50	Gt	≥400	≥480	≥22	-18°C: 27	AW	
MIX-50	A5.18 ER70S-3	80%Ar-20%CO ₂	DC-EP	•Suitable for butt and fillet welding in all positions •Suitable for lower currents	F HF H VU OH	Ex	0.10	0.55	1.11	0.012	0.011	0.24	Ex	440	540	32	-18°C: 170	AW	
														0.90~1.40	≤0.025	≤0.030	≤0.50	Gt	≥400
MIX-50S	A5.18 ER70S-G	80%Ar-20%CO ₂	DC-EP	•Suitable for butt and fillet welding in all positions •Suitable for higher currents	F HF H VU OH	Ex	0.07	0.57	1.17	0.010	0.013	0.24	Ex	470	550	32	-18°C: 170	AW	
														1.00~1.60	≤0.030	≤0.030	≤0.50	Gt	≥400
MG-S50	A5.18 ER70S-G	Ar-5~20%CO ₂	DC-EP	•Suitable for butt and fillet welding in all positions	F HF H VU OH	Ex	0.11	0.72	1.41	0.010	0.011	0.24	Ex	450	570	28	-29°C: 180	AW 80%Ar-20%CO ₂	
		Ar-2~5%O ₂	DC-EP					Gt							≥400	≥480	≥22	-29°C ≥27	AW
						Gt	≤0.12	0.50~1.00	1.20~1.60	≤0.025	≤0.025	≤0.50	Ex	490	590	33	-29°C: 180	AW 98%Ar-2%O ₂	
													Gt	≥400	≥480	≥22	-29°C ≥27	AW	

Note: Welding tests are as per AWS. Ex: Example, Gt: Guaranty

■ Approvals

MG-50T	AB, LR, NV, BV, NK, CR, KR
MIX-50	AB, NK
MIX-50S	AB, LR, NV, NK, GL

■ Diameter. (mm)

MG-50T	0.8, 0.9, 1.0, 1.2, 1.4, 1.6	MIX-50S	0.9, 1.0, 1.2, 1.4, 1.6
MIX-50	0.9, 1.0, 1.2	MG-S50	0.8, 0.9, 1.0, 1.2, 1.4, 1.6

TG-S50

FAMILIARC™

TIG welding rod and wire for mild steel, 490MPa high tensile strength steel and aluminium-killed steel for low temperature service

Classification: ASME / AWS A5.18 ER70S-G
JIS Z3316 YGT50

Features: • Good impact value at low temperatures

Shielding Gas: Ar

Polarity: DC-EN

Chemical composition of rod and wire (%) as per AWS

	C	Si	Mn	P	S	Cu	Al	Ti	Zr
Example	0.10	0.74	1.40	0.009	0.010	0.24	0.01	0.01	0.01
Guaranty	≤0.12	≤0.95	1.00~ 1.50	≤0.025	≤0.025	≤0.50	≤0.15	≤0.15	≤0.12

Mechanical properties of all-weld metal as per AWS

	0.2%OS (MPa)	TS (MPa)	EI (%)	IV (J)	PWHT (°C×h)
Example	480	580	33	-29°C: 180	AW
	380	500	36	-29°C: 230	625x8
Guaranty	≥400	≥480	≥22	-29°C≥27	AW

Approvals

AB	LR	NV	BV	NK	Others
3*,3Y*	3Ym(H15)	III YM	SA3YM	KSW53G	CCS

Packages

Dia. (mm)	Type	Weight (kg)	Length (mm)	Weight per piece (g)
0.8	spool	10	-	-
1.2	spool	10	-	-
	spool	20	-	-
	tube	5	1,000	9
1.6	spool	10	-	-
	tube	5	1,000	16
2.0	tube	5	1,000	25
2.4	tube	5	1,000	35
3.2	tube	5	1,000	63

TG-S51T

FAMILIARC™

TIG welding rod and wire for mild steel, 490MPa high tensile strength steel and aluminium-killed steel for low temperature service

Classification: ASME / AWS A5.18 ER70S-6
JIS Z3316 YGT50

Features: • Its tensile strength after long time PWHT is high enough for 490MPa

Shielding Gas: Ar

Polarity: DC-EN

Chemical composition of rod and wire (%) as per AWS

	C	Si	Mn	P	S	Cu	Al	Ti	Zr
Example	0.10	0.89	1.56	0.010	0.011	0.23	0.01	0.01	0.01
Guaranty	0.07~ 0.15	0.80~ 1.00	1.40~ 1.85	≤0.025	≤0.025	≤0.50	≤0.15	≤0.15	≤0.12

Mechanical properties of all-weld metal as per AWS

	0.2%OS (MPa)	TS (MPa)	EI (%)	IV (J)	PWHT (°C×h)
Example	510	610	32	-29°C: 210	AW
	420	550	35	-29°C: 160	625x24
Guaranty	≥400	≥480	≥22	-29°C≥27	AW

Approvals

Others

TÜV

Packages

dia. (mm)	Type	Weight (kg)	Length (mm)	Weight/ piece(g)
0.8	spool	10	-	-
1.2	spool	10	-	-
1.6	tube	5	1,000	16
2.0	tube	5	1,000	25
2.4	tube	5	1,000	35
3.2	tube	5	1,000	63

TIG welding rod and wire for mild steel and 490 MPa high tensile strength steel

Classification: ASME / AWS A5.18 ER70S-2
JIS Z3316 YGT50

Features: •Suitable for root pass welding of pipes

Shielding Gas: Ar

Polarity: DC-EN

Chemical composition of rod and wire (%) as per AWS

	C	Si	Mn	P	S	Cu	Al	Ti	Zr
Example	0.04	0.54	1.25	0.007	0.014	0.25	0.07	0.08	0.04
Guaranty	≤0.07	0.40~ 0.70	0.90~ 1.40	≤0.025	≤0.030	≤0.50	0.05~ 0.15	0.05~ 0.15	0.02~ 0.12

Mechanical properties of all-weld metal as per AWS

	0.2%OS (MPa)	TS (MPa)	EI (%)	IV (J)	PWHT (°C×h)
Example	560	620	28	-29°C: 200	AW
	520	600	30	-29°C: 160	625x8
Guaranty	≥400	≥480	≥22	-29°C≥27	AW

Packages

dia. (mm)	Type	Weight (kg)	Length (mm)	Weight per piece(g)
0.9	spool	10	-	-
1.2	tube	5	1,000	9
1.6	spool	20	-	-
	tube	5	1,000	16
2.0	tube	5	1,000	25
2.4	tube	5	1,000	35
3.2	tube	5	1,000	63

G-50/US-36

FAMILIARC™

SAW flux and wire combination for mild steel and 490MPa high tensile strength steel

Classification: ASME / AWS A5.17 F7A2-EH14
JIS Z3183 S502-H

Features : •Suitable for butt and fillet welding of thin plates at high speeds
•DC-EP (CP type power source) is better for sheet metal of 4mm or thinner

Redrying conditions of flux: 150~350°Cx1h

Chemical composition of wire (%) as per AWS

	C	Si	Mn	P	S	Cu
Example	0.12	0.03	1.95	0.013	0.005	0.11
Guaranty	0.10~0.20	≤0.10	1.70~2.20	≤0.030	≤0.030	≤0.35

Chemical composition of weld metal (%) as per AWS

	C	Si	Mn	P	S
Example	0.12	0.20	1.36	0.013	0.013

Mechanical properties of weld metal as per AWS

	0.2%OS (MPa)	TS (MPa)	EI (%)	IV (J)	PWHT (°C×h)
Example	440	540	29	-29°C: 40	AW
Guaranty	≥400	480~660	≥22	-29°C≥27	AW

Polarity

Example	AC
Guaranty	AC

Packages

Wire			Flux		
Dia. (mm)	Type	Weight (kg)	Mesh size	Type	Weight (kg)
1.6	spool	10,20	8x48	can	25
2.0	spool	10,20	12x65	can	25
2.4	coil	25,76,150	12x150	can	25
	spool	10,20	20xD	can	25
3.2	coil	25,76,150			
4.0	coil	25,75,150			
4.8	coil	25,75,150			
6.4	coil	25,78,159			

G-60/US-36

FAMILIARC™

SAW flux and wire combination for mild steel and 490MPa high tensile strength steel

Classification: ASME / AWS A5.17 F7A2-EH14
JIS Z3183 S502-H

Features : •Suitable for butt and fillet welding of thin or medium plate at high speeds

Redrying conditions of flux: 150~350°Cx1h

Chemical composition of wire (%) as per AWS

	C	Si	Mn	P	S	Cu
Example	0.12	0.03	1.95	0.013	0.005	0.11
Guaranty	0.10~0.20	≤0.10	1.70~2.20	≤0.030	≤0.030	≤0.35

Chemical composition of weld metal (%) as per AWS

	C	Si	Mn	P	S
Example	0.10	0.27	1.34	0.016	0.015

Mechanical properties of weld metal as per AWS

	0.2%OS (MPa)	TS (MPa)	EI (%)	IV (J)	PWHT (°C×h)
Example	460	560	27	-29°C: 40	AW
Guaranty	≥400	480~660	≥22	-29°C≥27	AW

Polarity

Example	AC
Guaranty	AC

Approvals

	AB	LR	NV	BV	NK	Others
Single	1T	1T	1T	A1T	KAW1TM	CR

Packages

Wire			Flux		
Dia. (mm)	Type	Weight (kg)	Mesh size	Type	Weight (kg)
1.6	spool	10,20	12x65	can	25
2.0	spool	10,20	12x150	can	25
2.4	coil	25,76,150			
	spool	10,20			
3.2	coil	25,76,150			
4.0	coil	25,75,150			
4.8	coil	25,75,150			
6.4	coil	25,78,159			

SAW flux and wire combination for mild steel and 490MPa high tensile strength steel

Classification : ASME / AWS A5.17 F7A6-EH14
F7P6-EH14

JIS Z3183 S502-H

Features : • Suitable for butt and flat fillet welding of medium or heavy thick plate
• Excellent mechanical properties of weld metal by multi-pass welding

Redrying conditions of flux: 150~350°Cx1h

Chemical composition of wire (%) as per AWS

	C	Si	Mn	P	S	Cu
Example	0.12	0.03	1.95	0.013	0.005	0.11
Guaranty	0.10~0.20	≤0.10	1.70~2.20	≤0.030	≤0.030	≤0.35

Chemical composition of weld metal (%) as per AWS

	C	Si	Mn	P	S
Example	0.09	0.32	1.63	0.018	0.011

Mechanical properties of weld metal as per AWS

	0.2%OS (MPa)	TS (MPa)	EI (%)	IV (J)	PWHT (°C×h)
Example	490	570	30	-51°C: 59	AW
	420	530	31	-51°C: 64	620x1
Guaranty	≥400	480~660	≥22	-51°C≥27	AW
	≥400	480~660	≥22	-51°C≥27	620±15x1

Polarity

Example	AC
Guaranty	AC

Approvals

	AB	LR	NV	BV	NK	Others
Single	2T,2YT 3M,3YM	2T,2YT 3YM	II YT (III YM)	A2,2YT 3,3YM	KAW52T, 53M	GL, CR, KR

Packages

Wire

Dia. (mm)	Type	Weight (kg)
1.6	spool	10,20
2.0	spool	10,20
2.4	coil	25,76,150
	spool	10,20
3.2	coil	25,76,150
4.0	coil	25,75,150
4.8	coil	25,75,150
6.4	coil	25,78,159

Flux

Mesh size	Type	Weight (kg)
12x65	can	25
20x200	can	25
20xD	can	25

MF-300/US-36

FAMILIARC™

SAW flux and wire combination for mild steel and 490MPa high tensile strength steel

Classification : ASME / AWS A5.17 F7A6-EH14
F7P6-EH14

JIS Z3183 S502-H

Features : •Suitable for butt and flat fillet welding of medium or heavy thick plate
•Excellent slag removal and good mechanical properties

Redrying conditions of flux: 150~350°Cx1h

Chemical composition of wire (%) as per AWS

	C	Si	Mn	P	S	Cu
Example	0.12	0.03	1.95	0.013	0.005	0.11
Guaranty	0.10~0.20	≤0.10	1.70~2.20	≤0.030	≤0.030	≤0.35

Chemical composition of weld metal (%) as per AWS

	C	Si	Mn	P	S
Example	0.12	0.27	1.32	0.015	0.009

Mechanical properties of weld metal as per AWS

	0.2%OS (MPa)	TS (MPa)	EI (%)	IV (J)	PWHT (°C×h)
Example	470	570	30	-51°C: 90	AW
	410	520	31	-51°C: 82	620x1
Guaranty	≥400	480~660	≥22	-51°C≥27	AW
	≥400	480~660	≥22	-51°C≥27	620±15x1

Polarity

Example	AC
Guaranty	AC

Approvals

	AB	LR	NV	Others
Single	2T,2YT,3M,3YM	2T,2YT,3YM	II YT(III YM)	GL

Packages

Wire			Flux		
Dia. (mm)	Type	Weight (kg)	Mesh size	Type	Weight (kg)
1.6	spool	10,20	20x200	can	25
2.0	spool	10,20	20xD	can	25
2.4	coil	25,76,150			
	spool	10,20			
3.2	coil	25,76,150			
4.0	coil	25,75,150			
4.8	coil	25,75,150			
6.4	coil	25,78,159			

Trade designation	ASME AWS Class.	Type of flux	Pol.	Features	Chemical composition (%)					Mechanical properties of weld metal						
					C	Si	Mn	P	S	0.2%OS (MPa)	TS (MPa)	EI (%)	IV(J)	PWHT (°Cxh)		
G-80/US-36	A5.17 F7A2-EH14 F6P2-EH14	Fused	AC	<ul style="list-style-type: none"> •Suitable for butt and flat fillet welding of medium or heavy thick plate •Good Mechanical properties in multi-pass welding •RC: 150~350°Cx1h 	Wire-Ex	0.12	0.03	1.95	0.013	0.005	Ex	410	520	29	-29°C: 43	AW
					Wire-Gt	0.10~0.20	≤0.10	1.70~2.20	≤0.030	≤0.030		360	500	35	-29°C: 82	620 x1
												≥400	480~660	≥22	-29°C ≥27	AW
					Weld-Ex	0.13	0.21	1.07	0.014	0.016	Gt	≥330	410~550	≥22	-29°C ≥27	620±15 x1
MF-53/US-36	A5.17 F7A0-EH14	Fused	AC	<ul style="list-style-type: none"> •Suitable for fillet welding for both single and multiple electrodes procedures •Excellent bead appearance and slag removal •RC: 150~350°Cx1h 	Wire-Ex	0.12	0.03	1.95	0.013	0.005	Ex	430	510	29	-18°C: 40	AW
					Wire-Gt	0.10~0.20	≤0.10	1.70~2.20	≤0.030	≤0.030						
					Weld-Ex	0.05	0.67	1.61	0.016	0.009	Gt	≥400	480~660	≥22	-18°C ≥27	AW
PF-H45/US-43	A5.17 F6A4-EL8	Bonded	AC	<ul style="list-style-type: none"> •Suitable for butt welding •Excellent bead appearance with high currents •Maximum 5 passes are recommended in multi-pass welding •RC: 200~300°Cx1h 	Wire-Ex	0.07	0.01	0.44	0.015	0.008	Ex	400	510	29	-40°C: 87	AW
					Wire-Gt	≤0.10	≤0.07	0.25~0.60	≤0.030	≤0.030						
					Weld-Ex	0.07	0.53	1.30	0.015	0.006	Gt	≥330	410~550	≥22	-40°C ≥27	AW

Note: Welding tests are as per AWS. Wire-Ex: Example of wire, Wire-Gt: Guaranty of wire, Ex: Example of weld metal (polarity: AC), Gt: Guaranty of weld metal (polarity: AC)

Weld-Ex: Example of weld metal

Approvals

G-80/US-36	AB, LR, NV, BV, NK, KR
MF-53/US-36	AB, LR, NV, NK
PF-H45/US-43	AB, LR, NV, BV, NK, GL, CR

Diameter of wire (mm)

US-36	1.6, 2.0, 2.4, 3.2, 4.0, 4.8, 6.4
US-43	2.4, 3.2, 4.0, 4.8, 6.4

Mesh size of flux

G-80	12x65, 12x200, 20x200, 32x200, 20xD
MF-53	8x48
PF-H45	10x48

Trade designation	ASME AWS Class.	Type of flux	Pol.	Features	Chemical composition (%)						Mechanical properties of weld metal						
					C	Si	Mn	P	S	Mo	0.2%OS (MPa)	TS (MPa)	EI (%)	IV (J)	PWHT		
PF-H55E/ US-36	A5.17 F7A4 -EH14	Bonded	AC	<ul style="list-style-type: none"> •Suitable for single-pass-on-both-sides or multi-layer butt welding •Good bead appearance and excellent impact value •RC: 200~300°Cx1h 	Wire-Ex	0.12	0.03	1.95	0.013	0.005	-	Ex	460	530	32	-40°C: 118	AW
					Wire-Gt	0.10~ 0.20	≤0.10	1.70~ 2.20	≤0.030	≤0.030	-						
					Weld-Ex	0.09	0.21	1.23	0.015	0.007	-	Gt	≥400	480~ 660	≥22	-40°C ≥27	AW

Note: Welding tests are as per AWS. Wire-Ex: Example of wire, Wire-Gt: Guaranty of wire, Ex: Example of weld metal (polarity: AC), Gt: Guaranty of weld metal (polarity: AC)

Weld-Ex: Example of weld metal

Approvals

PF-H55E/US-36 AB, LR, NV, BV, NK, GL, CR

Diameter of wire (mm)

US-36 1.6, 2.0, 2.4, 3.2, 4.0, 4.8, 6.4

Mesh size of flux

PF-H55E 10x48

Welding Consumables and Proper Welding Conditions for

- **Shielded Metal Arc Welding (SMAW)**
- **Flux Cored Arc Welding (FCAW)**
- **Gas Metal Arc Welding (GMAW)**
- **Submerged Arc Welding (SAW)**

For Weather Proof Steel

■ A guide for selecting welding consumables

Table 1 shows suitable welding consumables for shielded metal arc welding (SMAW), flux cored arc welding (FCAW), gas metal arc welding (GMAW), and submerged arc welding (SAW) of weather proof steels.

Table 1 Welding consumables for weather proof steel ⁽¹⁾

Steel grade	ASTM	JIS G3114	ASTM	JIS G3114
		A709 Gr.36	SMA400P SMA400W SMA490P SMA490W	A588 A709 Gr.50W A242
SMAW	LB-W52B		LB-W588 LB-W62G	LB-W62G
FCAW	DW-50W		DW-588	-
GMAW	MG-W50TB		-	-
SAW	MF-38 / US-W52B MF-38A / US-W52B MF-53 / US-W52B (HF)		-	MF-38 / US-W62B MF-63 / US-W62B (HF)

Note (1) F, H, and HF designate suitable welding position.

■ Tips for better welding results

In addition to the tips for mild steel and 490MPa high tensile strength steel, the following notes should be taken into consideration in welding weather proof steels.

- (1) Remove rust and dirt from welding grooves to prevent pits and blowholes in the weld metal.
- (2) Use an appropriate welding procedure taking into account the requirements for the mechanical properties of the weldment, because heat input, interpass temperature and plate thickness affect the cooling rate of welds and, where the cooling rate is excessively low, the tensile strength and notch toughness of the weld decrease.
- (3) Use appropriate preheating according to the type of base metal and the thickness of the work to prevent cold cracking in the weld. Table 2 shows the minimum preheat temperatures used in general applications.

Table 2 Minimum preheat temperatures (°C) for general uses for several steel grades and thicknesses

Steel grade (See Table 1)	Type of welding joint	Welding process	Plate thickness (mm)		
			25 max	Over 25 Up to 38	Over 38 Up to 50
A709 Gr.36 SMA400P SMA400W	Groove Fillet	SMAW	-	50	100
		FCAW, GMAW, SAW	-	-	50
A588 A709 Gr.50W A242 SMA490P SMA490W	Groove Fillet	SMAW	50	100	100
		FCAW, GMAW, SAW	-	-	50
SMA570P SMA570W	Groove Fillet	SMAW	50	100	100
		SAW, GMAW	50	50	50

- (4) For welding a high-phosphorous weather proof steel (e.g., A242), use lower welding currents and slower welding speeds to prevent hot cracking.

Trade designation	ASME AWS Class.	Type of covering	Pol.	Features	WP	Chemical composition of all-weld metal (%)										Mechanical properties of all-weld metal			
						C	Si	Mn	P	S	Cu	Ni	Cr	0.2%OS (MPa)	TS (MPa)	EI (%)	IV (J)		
LB-W52	A5.5 E7016 -G	Low hydrogen	AC	•Suitable for butt and fillet welding of weather proof steel (with painting) •RC: 300~350°C x0.5~1h	F	Ex	0.07	0.48	0.82	0.010	0.005	0.31	0.33	-	Ex	490	550	31	-29°C: 130
			DC-EP		H VU OH	Gt	≤0.12	≤0.90	0.30~1.40	≤0.040	≤0.030	0.20~0.60	0.25~0.70	-	Gt	≥390	≥480	≥25	-
LB-W52B	A5.5 E7016 -G	Low hydrogen	AC	•Suitable for butt and fillet welding of weather proof steel (without painting) •RC: 350~400°C x1h	F	Ex	0.05	0.54	0.63	0.010	0.004	0.38	0.20	0.59	Ex	480	570	29	-29°C: 140
			DC-EP		H VU OH	Gt	≤0.12	≤0.90	0.30~1.40	≤0.040	≤0.030	0.30~0.70	0.05~0.70	0.45~0.75	Gt	≥390	≥480	≥25	-
LB-W588	A5.5 E8016 -C3	Low hydrogen	AC	•Suitable for butt and fillet welding of ASTM A588 and A242 steel •RC: 350~400°C x1h	F	Ex	0.07	0.57	1.10	0.010	0.007	-	1.06	-	Ex	520	600	30	-40°C: 120
			DC-EP		H VU OH	Gt	≤0.12	≤0.80	0.40~1.25	≤0.03	≤0.03	-	0.80~1.10	-	Gt	470~550	≥550	≥24	-40°C: ≥27
LB-W62G	A5.5 E8018 -W2	Low hydrogen	AC	•Suitable for butt and fillet welding of 570MPa class weather proof steel •Applicable for ASTM A588 and A242 steel •RC: 350~400°C x1h	F	Ex	0.07	0.58	1.02	0.009	0.004	0.35	0.49	0.57	Ex	540	640	29	-18°C: 160
			DC-EP		H VU OH	Gt	≤0.12	0.35~0.80	0.50~1.30	≤0.03	≤0.03	0.30~0.75	0.40~0.80	0.45~0.70	Gt	≥460	≥550	≥19	-18°C: ≥27

Note: Welding tests are as per AWS. Ex: Example (polarity: AC),

Gt: Guaranty (polarity: as specified above)

■ Diameter and Length (mm)

	Dia.	2.6	3.2	4.0	5.0
LB-W52		350	350	400	450
LB-W52B		-	350	400	450
LB-W588		300	350	400	400
LB-W62G		350	350	400	450

Trade designation	ASME AWS Class.	Type of cored flux	SG	Pol.	Features	WP	Chemical		composition of all-weld metal (%)						Mechanical properties of all-weld metal					
							C	Si	Mn	P	S	Cu	Cr	Ni	0.2%OS (MPa)	TS (MPa)	EI (%)	IV (J)		
DW-50W	-	Rutile	CO ₂	DC-EP	•Suitable for butt and fillet welding in all positions •Applicable for weather proof steel which is used normally without painting	F	Ex	0.06	0.35	1.06	0.013	0.008	0.39	0.54	0.38	Ex	510	590	27	0°C: 140
						HF H VU OH	Gt	≤0.12	≤0.90	0.50~1.60	≤0.03	≤0.03	0.30~0.60	0.45~0.75	0.05~0.70	Gt	≥390	≥490	≥20	0°C ≥47
DW-588	A5.29 E81T1-W2C	Rutile	CO ₂	DC-EP	•Suitable for butt and fillet welding in all positions •Applicable for A588 steel which is used normally without painting	F	Ex	0.04	0.55	1.14	0.012	0.010	0.41	0.52	0.48	Ex	550	620	27	-29°C: 60
						HF H VU OH	Gt	≤0.12	0.35~0.80	0.50~1.30	≤0.03	≤0.03	0.30~0.75	0.45~0.70	0.40~0.80	Gt	≥470	550~690	≥19	-29°C ≥27

Note: Welding tests are as per AWS. Ex: Example, Gt: Guaranty

Diameter (mm)	
DW-50W	1.2, 1.4, 1.6
DW-588	1.2

Trade designation	ASME AWS Class.	SG	Pol.	Features	WP	Chemical			composition of wire (%)					Mechanical properties of all-weld metal									
						C	Si	Mn	P	S	Cr	Ni	Cu	0.2%OS (MPa)	TS (MPa)	EI (%)	IV (J)	SG					
MG-W50TB	A5.28 ER80S -G	CO ₂ 80%Ar- 20%CO ₂	DC- EP	<ul style="list-style-type: none"> •Applicable for weatherproof steel which is used normally without painting •Lower currents are suitable 	F	Ex	0.03	0.77	1.39	0.012	0.010	0.61	0.19	0.45	Ex	450	560	30	0°C: 110	CO ₂			
					HF													480	580	29	-18°C: 120	80%Ar- 20%CO ₂	
					H																		
					VU																		
					OH	Gt	≤0.15	0.30~ 1.20	0.70~ 1.80	≤0.030	≤0.030	0.50~ 0.80	0.05~ 0.70	0.30~ 0.60	Gt	≥400	≥550	≥19	0°C ≥47	CO ₂			

Note: Welding tests are as per AWS. Ex: Example, Gt: Guaranty

■ Diameter (mm)

MG-W50TB 0.9, 1.0, 1.2

Trade designation	ASME AWS Class.	Type of flux	Pol.	Features	Chemical composition (%)								Mechanical properties of weld metal					
					C	Si	Mn	P	S	Cu	Cr	Ni	0.2%OS (MPa)	TS (MPa)	EI (%)	IV (J)		
MF-38/ US-W52B	A5.23 F7A2 -EG-G	Fused	AC	<ul style="list-style-type: none"> •Suitable for butt and flat fillet welding (without painting) •Good impact value •RC: 150~350°Cx1h 	Wire-Ex	0.10	0.03	1.51	0.010	0.008	0.36	0.62	0.14	Ex	490	590	25	-29°C: 76
					Wire-Gt	≤0.15	≤0.10	1.20~ 1.80	≤0.025	≤0.025	0.30~ 0.55	0.50~ 0.80	0.10~ 0.25					
					Weld-Ex	0.05	0.32	1.48	0.017	0.005	0.35	0.51	0.14					
MF-38A/ US-W52B	A5.23 F7A2 -EG-G	Fused	AC	<ul style="list-style-type: none"> •Suitable for butt and flat fillet welding (without painting) •Pockmarks hardly occur •RC: 150~350°Cx1h 	Wire-Ex	0.10	0.03	1.51	0.010	0.008	0.36	0.62	0.14	Ex	480	570	26	-29°C: 59
					Wire-Gt	≤0.15	≤0.10	1.20~ 1.80	≤0.025	≤0.025	0.30~ 0.55	0.50~ 0.80	0.10~ 0.25					
					Weld-Ex	0.06	0.39	1.36	0.018	0.006	0.36	0.54	0.15					
MF-53/ US-W52B	A5.23 F7A0 -EG-G	Fused	AC	<ul style="list-style-type: none"> •Suitable for fillet welding (without painting) •Excellent bead appearance and good slag removal •RC: 150~350°Cx1h 	Wire-Ex	0.10	0.03	1.51	0.010	0.008	0.36	0.62	0.14	Ex	430	530	23	-18°C: 35
					Wire-Gt	≤0.15	≤0.10	1.20~ 1.80	≤0.025	≤0.025	0.30~ 0.55	0.50~ 0.80	0.10~ 0.25					
					Weld-Ex	0.05	0.58	1.35	0.009	0.007	0.36	0.59	0.18					

Note: Welding tests are as per AWS. Wire-Ex: Example of wire, Wire-Gt: Guaranty of wire, Ex: Example of weld metal (polarity: AC), Gt: Guaranty of weld metal (polarity: AC)

Weld-Ex: Example of weld metal

■ Diameter of wire (mm)

US-W52B 1.6, 2.0, 2.4, 3.2, 4.0, 4.8

■ Mesh size of flux

MF-38 12x65, 20x200, 20xD

MF-38A 12x65, 20x200, 20xD

MF-53 8x48

SAW Flux and Wire Combinations for Weather Proof Steel

Trade designation	ASME AWS Class.	Type of flux	Pol.	Features		Chemical composition (%)								Mechanical properties of weld metal				
						C	Si	Mn	P	S	Cu	Cr	Ni	0.2%OS (MPa)	TS (MPa)	EI (%)	IV (J)	
[F]MF-38/ [F]US-W62B	A5.23 F8A2 -EG-G	Fused	AC	<ul style="list-style-type: none"> •Suitable for butt and flat fillet welding (without painting) •Good mechanical properties •RC: 150~350°Cx1h 	Wire-Ex	0.09	0.03	1.54	0.011	0.009	0.38	0.66	0.18	Ex	540	620	25	-29°C: 67
					Wire-Gt	≤0.15	≤0.10	1.20~ 1.80	≤0.025	≤0.025	0.30~ 0.55	0.50~ 0.80	0.10~ 0.25					
					Weld-Ex	0.05	0.32	1.53	0.02	0.006	0.33	0.59	0.18					
[T]MF-63/ [F]US-W62B	A5.23 F8A0 -EG-G	Fused	AC	<ul style="list-style-type: none"> •Suitable for fillet welding (without painting) •Good usability in flat and horizontal fillet welding •RC: 150~350°Cx1h 	Wire-Ex	0.09	0.03	1.54	0.011	0.009	0.38	0.66	0.18	Ex	510	600	22	-18°C: 31
					Wire-Gt	≤0.15	≤0.10	1.20~ 1.80	≤0.025	≤0.025	0.30~ 0.55	0.50~ 0.80	0.10~ 0.25					
					Weld-Ex	0.05	0.52	1.36	0.013	0.009	0.31	0.49	0.12					

Note: Welding tests are as per AWS. Wire-Ex: Example of wire, Wire-Gt: Guaranty of wire, Ex: Example of weld metal (polarity: AC), Gt: Guaranty of weld metal (polarity: AC)

Weld-Ex: Example of weld metal, Weld-Gt: Guaranty of weld metal

Diameter of wire (mm)

US-W62B 1.6, 2.0, 2.4, 3.2, 4.0, 4.8

Mesh size of flux

MF-38 12x65, 20x200, 20xD

MF-63 8x48

Welding Consumables and Proper Welding Conditions for

- **Shielded Metal Arc Welding (SMAW)**
- **Flux Cored Arc Welding (FCAW)**
- **Gas Metal Arc Welding (GMAW)**
- **Gas Tungsten Arc Welding (GTAW)**
- **Submerged Arc Welding (SAW)**

For 590-780MPa High Tensile Strength Steel and Low Temperature Steel

■ A guide for selecting welding consumables ⁽¹⁾

TS	≥ 490MPa	≥ 520MPa	≥ 550MPa
YS	≥ 350MPa	≥ 400MPa	≥ 420MPa
IV	≥ 35J	≥ 40J	≥ 42J

SMAW			
-20°C	LB-52 (AC, DC-EP, SR) LB-52A (AC, DC-EP, SR)	LB-57 (AC, DC-EP, SR)	LB-62UL (AC, DC-EP, SR) LB-62 (AC, DC-EP, SR)
-40°C	LB-7018-1 (DC-EP)	NB-1SJ (AC, DC-EP, SR)	NB-1SJ (AC, SR) LB-62L (AC, DC-EP, SR)
-60°C	NB-1SJ (AC, DC-EP, SR) LB-52NS (AC, DC-EP, SR)	LB-52NS (AC)	

FCAW, GMAW ⁽²⁾			
-20°C	DW-100E (100%CO ₂) MG-S50 (Ar-20%CO ₂ , SR)	DW-55L (100%CO ₂) DW-A81Ni1 (Ar-20%CO ₂) MG-T1NS (Ar-20%CO ₂)	
-30°C	DW-55E (100%CO ₂) DW-A55E (Ar-20%CO ₂)		
-40°C	DW-A55ESR (Ar-20%CO ₂ , SR)		
-50°C	DW-50LSR (100%CO ₂ , SR)	DW-55LSR (100%CO ₂ , SR)	DW-A81Ni1 (Ar-20%CO ₂)
-60°C	DW-55L (100%CO ₂) DW-A55L (Ar-20%CO ₂) MG-S50LT (Ar-20%CO ₂ , SR) MX-A55Ni1 (Ar-20%CO ₂)	DW-A55L (Ar-20%CO ₂) DW-A55LSR (Ar-20%CO ₂ , SR) MG-S50LT (Ar-20%CO ₂) MX-A55Ni1 (Ar-20%CO ₂)	DW-55LSR (100%CO ₂) DW-A55L (Ar-20%CO ₂) DW-A55LSR (Ar-20%CO ₂) MX-A55Ni1 (Ar-20%CO ₂)

GTAW ⁽³⁾			
-20°C	TG-S50 (SR) TG-S51T (SR)	TG-S62 (SR) TG-S60A (SR)	TG-S62 (SR) TG-S60A (SR)
-30°C			
-40°C	TG-S1MT	TG-S60A (SR)	TG-S60A (SR)
-60°C	TG-S1N		

SAW			
-20°C	MF-38 / US-36 (AC, SR)	MF-38 / US-49A (AC, SR)	
-40°C	PF-H55AS / US-36J (DC-EP, SR) PF-H55LT / US-36 (AC, SR)	PF-H55S / US-49A (AC, SR)	PF-H55S / US-49A (AC, SR) PF-H80AK / US-56B (DC-EP)
-60°C		PF-H55AS / US-36J (DC-EP) PF-H55LT / US-36 (AC) PF-H55LT / US-36J (AC, SR)	PF-H55LT / US-36J (AC)

≥ 610MPa	≥ 670MPa	≥ 770MPa
≥ 500MPa	≥ 550MPa	≥ 690MPa
≥ 50J	≥ 55J	≥ 69J

LB-62UL (AC, DC-EP, SR) LB-62 (AC, DC-EP, SR)	LB-106 (AC, DC-EP)	LB-80UL (AC) LB-116 (AC)
LB-65L (DC-EP, SR) LB-62L (AC, SR) LB-67L (DC-EP, SR)	LB-70L (DCEP) LB-Y75 (AC)	LB-80L (DCEP) LB-88LT (AC)

DW-A65L (Ar-20%CO ₂) MG-T1NS (Ar-20%CO ₂)	MG-S70 (Ar-20%CO ₂)	MG-S80 (Ar-20%CO ₂)
DW-62L (100% CO ₂) DW-A62L (Ar-20%CO ₂) MG-S62L (Ar-20%CO ₂)	—	MG-S88A (Ar-20%CO ₂) MX-A80L (Ar-20%CO ₂)

TG-S62 (SR) TG-S60A (SR)	TG-S80AM (SR)
TG-S60A (SR)	

MF-38 / US-40 (AC)	PF-H80AK / US-255 (AC)	PF-H80AS / US-80LT (DC-EP) PF-H80AK / US-80LT (AC)
PF-H55S / US-40 (AC) PF-H80AK / US-56B (AC, DC-EP)		
PF-H80AK / US-56B (AC) PF-H55S/US-2N (AC, SR)		

Note (1) Welding consumables shown with SR are suitable for the as-welded and PWHT conditions.

(2) DW-XXX and DW-AXXX are flux-cored wires. MG-SXXX and MG-TXXX are solid wires.

(3) In one-side welding, back shielding is recommended.

(4) To prevent cold cracks or to assure mechanical properties of weld metals, preheating and interpass temperatures must be controlled as per an appropriate welding procedure spec.

For 590-780MPa High Tensile Strength Steel and Low Temperature Steel

■ Tips for better welding results

Common to individual welding processes

- (1) Use an appropriate welding procedure taking into account the requirements for the mechanical properties of the weldment, because heat input, Interpass temperature and plate thickness affect the cooling rate of welds and, where the cooling rate is excessively low, the tensile strength and notch toughness of the weld decrease.
- (2) Use appropriate preheat and Interpass temperatures to prevent cold cracking assisted by the diffusible hydrogen in welds. Suitable preheat and Interpass temperatures vary depending upon welding process, plate thickness, and kind of steel plate. In general, higher tensile strength steels need higher preheat and interpass temperatures.
- (3) Select appropriate welding consumables and welding conditions carefully particularly in cases where the weld metal dilution by the base metal is large, because the chemical composition of the weld metal can markedly be affected by the base metal chemical composition and thereby the properties of the weld metal can be varied.
- (4) Confirm the applicability of postweld heat treatment for welding consumables before use, because some welding consumables can provide good notch toughness only in the as-welded condition and some welding consumables can provide sufficient notch toughness in the postweld heat treated conditions.
- (5) Confirm the suitable electric current characteristics for welding consumables before use, because each welding consumable is designed to provide the highest performances with specific type of electric current (AC, DC, or both) and polarity (DC-EP, DC-EN, or both). Therefore, when a welding consumable designed for AC is used in DC or in opposite case, there are possibilities to deteriorate the properties of the weld metal and usability.
- (6) Some welding consumable can be used by both AC and DC-EP; however, the use of DC-EP causes a little decrease in strength of the weld metal.

SMAW

- (1) Low-hydrogen type electrodes should be stored in an oven (100-150°C) placed near the welding area after re-drying was finished. Take out minimize amounts of electrodes needed for a certain work from the oven. This manner is to keep the diffusible hydrogen content of the weld metal in a low level.
- (2) Use the backstep technique directly in the welding groove or strike an arc on a scrap plate before transferring the arc into the groove to prevent cracking.
- (3) Keep the arc length as short as possible to maintain good shielding by the coating flux decomposed gases during welding. The use of a long arc can cause a decrease of impact value of the weld metal caused by the nitrogen in the atmosphere and, where the arc length is excessive, blowholes can occur in the weld metal. Use a wind screen in windy areas.
- (4) Refer to the tips for Mild Steel and 490MPa High Tensile Strength Steel for other notes.

FCAW, GMAW, and GTAW

- (1) Use suitable shielding gas for each welding wire because the composition of a shielding gas can affect the mechanical properties of the weld metal.
- (2) Use a wind screen in windy areas to maintain the shielding gas in good condition. Insufficient or irregular shielding gas can cause weld defects.
- (3) Refer to the tips for welding Mild Steel and 490MPa High Tensile Strength Steel for other notes.

SAW

- (1) Remove rust, oil, grease, and water in the welding groove beforehand because such dirt can cause weld defects like pits and blowholes.
- (2) Select suitable steel plates and welding consumables carefully taking into account the dilution of weld metal by the base metal. Submerged arc welding characterizes deeper penetration and thus larger dilution; therefore, the properties of the weld metal can markedly be varied by the chemical composition of the base metal. Especially in the single-pass-on-both-side welding, the dilution ratio becomes as large as about 60% and thus the properties of the weld metal is considerably affected by the chemical composition of the base metal.
- (3) Refer to the tips for Mild Steel and 490MPa High Tensile Strength Steel for other notes.

■ How to prevent cold cracks in welding high tensile strength steels

In order to prevent cold cracks in arc welding, preheat temperature is a key factor, which relates to the hardenability of the steel material, the amount of diffusible hydrogen in the weld metal, and the degree of restraint of the welding joint. Fig. 1 shows the relationship between preheat temperature and the Cracking Parameter (P_C) which consists of the Cracking Parameter of Material (P_{CM}), plate thickness (t), and diffusible hydrogen (H). This diagram was developed through the y-groove cracking test of high tensile strength steels having a variety of chemical compositions. It can be considered that P_{CM} relates to the hardenability of a steel material, and plate thickness relates to the degree of restraint of a welding joint. Hence, P_C can be a guide to estimating the preheat temperature needed for preventing a cold crack in arc welding of a particular steel material.

However, in the stricter sense, the following formula (P_W) is more recommended to use for estimating the cooling time after welding that relates to preheat temperature, heat input, ambient temperature, and other factors to prevent a cold crack in arc welding of actual steel structures. The applicable ranges of individual parameters are given in Table 1.

$$P_W = P_{CM} + H/60 + R_F/400,000$$

where P_{CM} (%): the same as that contained in the P_C formula
 R_F (N/mm·mm): the degree of restraint of a welding joint

The degree of restraint (N/mm·mm) of a y-groove welding joint used for developing P_C is about 700 times the plate thickness (mm); if R_F is substituted by $700 \times t$, P_W becomes almost the same as P_C .

For 590-780MPa High Tensile Strength Steel and Low Temperature Steel

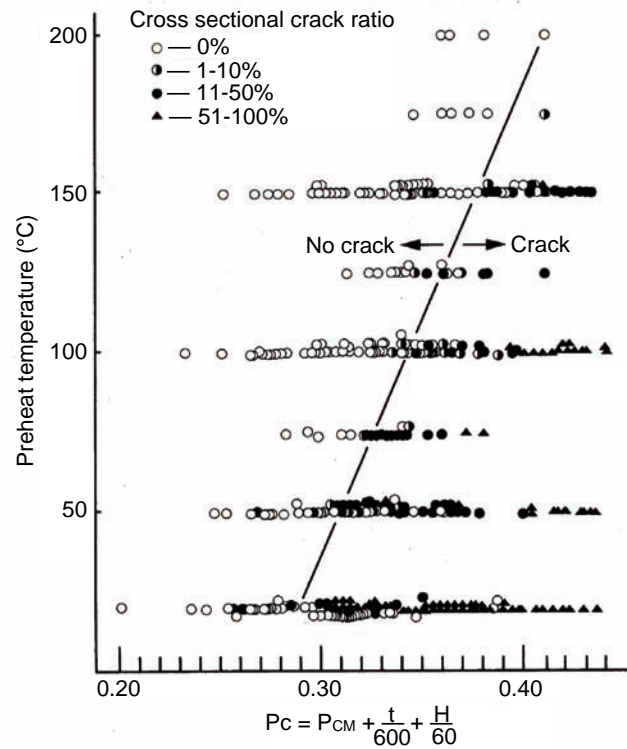

Fig. 1 Preheat temperature vs. cracking parameter (Plate thickness: 16~50 mm)

$P_{CM} = C + Si/30 + Mn/20 + Cu/20 + Ni/60 + Cr/20 + Mo/15 + V/10 + 5B$ (%)

t: Plate thickness (mm)

H: Content of diffusible hydrogen of deposited metal (Glycerine method) (ml/100 g)

H (Glycerine method) = 0.79H (Gas chromatography method) - 1.73

Table 1 Applicable ranges of parameters for P_w formula

Chemical composition of steels (%)										
C	Si	Mn	Cu	Ni	Cr	Mo	V	Ti	Nb	B
0.07~0.22	0~0.60	0.40~1.40	0~0.50	0~1.20	0~1.20	0~0.70	0~0.12	0~0.05	0~0.04	0~0.005
Amount of diffusible hydrogen, H			Plate thickness, t			Degree of restraint, R_F				
1.0~5.0 ml/100g			19~50 mm			5,000~33,000 N/mm-mm				

(References: WES 3001-1996 and JIS Z 3118-1992)

LB-7018-1 ▪ LB-52LT-18

TRUSTARC™

Iron powder low hydrogen type covered electrode for mild steel and 490MPa high tensile strength steel for low temperature service

Classification: ASME / AWS A5.1 E7018-1

Features: •Suitable for butt and fillet welding of structures for low temperature service steel
•LB-52LT-18: Excellent impact value after PWHT

Redrying Conditions: 350~400°Cx1 h

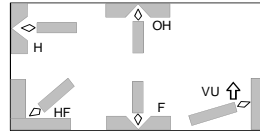
Welding Positions:**Chemical composition of all-weld metal (%) as per AWS**

		C	Si	Mn	P	S	Ti	B
LB-7018-1	Example	0.06	0.36	1.48	0.011	0.003	0.025	0.0035
	Guaranty	≤0.15	≤0.75	≤1.60	≤0.035	≤0.035	-	-
LB-52LT-18	Example	0.07	0.34	1.54	0.009	0.005	0.022	0.0032
	Guaranty	≤0.10	≤0.75	≤1.60	≤0.020	≤0.020		

Mechanical properties of all-weld metal as per AWS

		0.2%OS (MPa)	TS (MPa)	EI (%)	IV (J)	PWHT (°C/h)
LB-7018-1	Example	483	565	32	-60°C: 85	AW
	Guaranty	≥400	≥480	≥22	-45°C ≥27	AW
LB-52LT-18	Example	490	580	32	-60°C:130	AW
		470	560	32	-60°C:140	620x1
	Guaranty	≥400	≥480	≥22	-45°C ≥27	AW
		≥400	≥480	≥22	-45°C ≥27	620±15x1

Recommended welding parameters

Dia.	2.6mm	3.2mm	4.0mm	5.0mm
F, HF, H	60~90A	90~130A	130~180A	180~240A
VU, OH	50~80A	80~120A	110~170A	-

Polarity

Example	DC-EP
Guaranty	AC, DC-EP

Approvals (LB-7018-1)

AB	LR
4Y400(H10)	4Y40mH10

Packages

Dia. (mm)	Length (mm)		Weight per pack (kg)	Weight per carton (kg)	Weight per piece (g)	
	(LB-7018-1)	(LB-52LT-18)			(LB-7018-1)	(LB-52LT-18)
2.6	350	350 *	5	20	23	20
3.2	350	350	5	20	35	35
	-	450 *	5	20	-	39
4.0	400	-	5	20	61	-
	450	450	5	20	69	68
5.0	450	450	5	20	106	105

* : Special use for root pass

LB-62



Extra low hydrogen and moisture resistant type covered electrode for 550 to 610MPa high tensile strength steel

Classification: ASME / AWS A5.5 E9016-G
EN ISO 2560-A-E 50 3 Z B
JIS Z3212 D5816

Features: •Suitable for butt and fillet welding
Redrying Conditions: 350~400°Cx1h

Welding Positions:

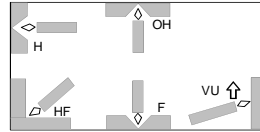

Chemical composition of all-weld metal (%) as per AWS

	C	Si	Mn	P	S	Ni	Mo
Example	0.07	0.61	1.15	0.011	0.005	0.63	0.26
Guaranty	≤0.09	0.40~ 0.75	0.75~ 1.35	≤0.020	≤0.020	0.40~ 0.75	0.20~ 0.40

Mechanical properties of all-weld metal as per AWS

	0.2%OS (MPa)	TS (MPa)	EI (%)	IV (J)
Example	550	650	30	-18°C: 150
Guaranty	≥530	≥620	≥17	-

Recommended welding parameters

	2.6mm	3.2mm	4.0mm	5.0mm	6.0mm
F, HF, H	55~85A	90~130A	130~180A	180~240A	250~310A
VU, OH	50~80A	80~115A	110~170A	150~200A	-

Polarity

Example	AC
Guaranty	AC, DC-EP

Approvals

AB	LR	NV	BV	NK	Others
3YQ500(H10)	3m,3Ym(H15)	3YH10	3,3YHH	KMW3Y50H10	CR

Packages

Dia. (mm)	Length (mm)	Weight per pack (kg)	Weight per carton (kg)	Weight per piece (g)
2.6	300	2	20	17
3.2	350	5	20	30
4.0	400	5	20	55
5.0	400	5	20	85
6.0	450	5	20	140

LB-62UL



Ultra low hydrogen and moisture resistant type covered electrode for 550 to 610MPa high tensile strength steel

Classification: ASME / AWS A5.5 E9016-G
EN ISO 2560-A-E 50 3 Z B
JIS Z3212 D5816

Features : •Suitable for butt and fillet welding
•Ultra low hydrogen type with excellent crack resistibility
Redrying Conditions: 350~430°Cx1h

Welding Positions:

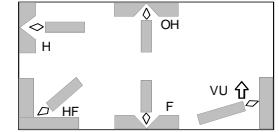

Chemical composition of all-weld metal (%) as per AWS

	C	Si	Mn	P	S	Ni	Mo
Example	0.07	0.63	1.13	0.010	0.006	0.65	0.25
Guaranty	≤0.09	0.40~ 0.75	0.75~ 1.35	≤0.020	≤0.020	0.45~ 0.80	0.20~ 0.40

Mechanical properties of all-weld metal as per AWS

	0.2%OS (MPa)	TS (MPa)	EI (%)	IV (J)
Example	550	650	30	-18°C: 160
Guaranty	≥530	≥620	≥17	-

Recommended welding parameters

	3.2mm	4.0mm	5.0mm	6.0mm
F, HF, H	90~130A	130~180A	180~240A	250~310A
VU, OH	80~115A	110~170A	150~200A	-

Polarity

Example	AC
Guaranty	AC, DC-EP

Approvals

Others	CCS
--------	-----

Packages

Dia. (mm)	Length (mm)	Weight per pack(kg)	Weight per carton(kg)	Weight per piece(g)
3.2	350	5	20	31
4.0	400	5	20	55
5.0	400	5	20	85
6.0	450	5	20	140

LB-62U



Extra low hydrogen and moisture resistant type covered electrode for 550-610MPa high tensile strength steel

Classification : ASME / AWS A5.5 E9016-G
JIS Z3211 E6216-N1M1 U

Features : •Suitable for one-side welding of pipes
•Extremely good arc stability in one-side welding with relatively low currents
•Extra low hydrogen type with excellent crack resistibility

Redrying Conditions: 350~400°Cx1h

Welding Positions:

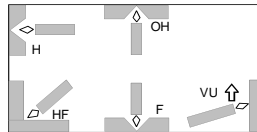

Chemical composition of all-weld metal (%) as per AWS

	C	Si	Mn	P	S	Ni	Mo
Example	0.08	0.64	1.03	0.010	0.004	0.59	0.24
Guaranty	≤0.09	0.40~ 0.75	0.70~ 1.20	≤0.020	≤0.020	0.45~ 0.80	0.20~ 0.40

Mechanical properties of all-weld metal as per AWS

	0.2%OS (MPa)	TS (MPa)	EI (%)	IV (J)
Example	560	650	26	-20°C: 88
Guaranty	≥530	≥620	≥17	-

Recommended welding parameters

	2.6mm	3.2mm	4.0mm
F, HF,H	60~90A	90~130A	130~180A
VU, OH	50~80A	80~115A	110~170A
Root pass	30~80A	60~110A	90~140A

Polarity

Example	DC-EP
Guaranty	DC-EP, AC (DCEN is also suitable for root pass.)

Approvals

AB
3YQ500(H10)

Packages

Dia. (mm)	Length (mm)	Weight per pack(kg)	Weight per carton(kg)	Weight per piece(g)
2.6	350	5	20	20
3.2	350	5	20	30
4.0	400	5	20	53

LB-52NS



Extra low hydrogen type covered electrode for mild steel and 490MPa high tensile strength steel for low temperature service

Classification : ASME / AWS A5.5 E7016-G
EN ISO 2560-A-E 42 6 Z B
JIS Z3212 D5016

Features : •Suitable for butt and fillet welding
•Good CTOD properties at temperatures down to -30°C
•Better impact values at temperatures down to -60°C

Redrying Conditions: 350~400°Cx1h

Welding Positions:

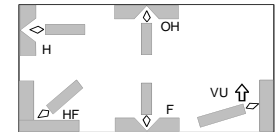

Chemical composition of all-weld metal (%) as per AWS

	C	Si	Mn	P	S	Ni	Ti	B
Example	0.08	0.40	1.38	0.012	0.007	0.48	0.023	0.0021
Guaranty	≤0.10	0.30~ 0.90	1.00~ 1.60	≤0.020	≤0.020	0.30~ 0.70	0.005~ 0.035	0.0005~ 0.0045

Mechanical properties of all-weld metal as per AWS

	0.2%OS (MPa)	TS (MPa)	EI (%)	IV (J)	PWHT (°C/h)
Example	490	580	29	-60°C: 130	AW
Guaranty	470	570	31	-60°C: 120	620x1
	≥390	≥480	≥25	-60°C≥27	AW
	≥390	≥480	≥25	-60°C≥27	620±15x1

Recommended welding parameters

	2.6mm	3.2mm	4.0mm	5.0mm	6.0mm
F, HF,H	55~85A	90~130A	130~180A	180~240A	250~310A
VU, OH	50~80A	80~120A	110~170A	150~200A	-

Polarity

Example	AC
Guaranty	AC, DC-EP

Approvals

AB	LR	NV	BV	NK
3H10,3Y,MG	5Y40m(H15)	5YH10,NV2-4(L), 4-4(L)	4Y40MHH,MG	KMWL3HH

Packages

Dia. (mm)	Length (mm)	Weight per pack(kg)	Weight per carton(kg)	Weight per piece(g)
2.6	300	2	20	17
3.2	350	5	20	31
4.0	400	5	20	55
5.0	450	5	20	97
6.0	450	5	20	140

NB-1SJ



Extra low hydrogen type covered electrode for 490 to 550MPa high tensile strength steel for low temperature service

Classification: ASME / AWS A5.5 E8016-G
JIS Z3241 DL5016-6AP1

- Features :**
- Suitable for butt and fillet welding of low temperature steel
 - Good CTOD properties at temperatures down to -45°C
 - Good impact values at temperatures down to -80°C
 - AC current is recommended for 550MPa HT class steel

Redrying Conditions: 350~400°Cx1h

Welding Positions:

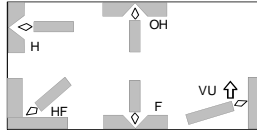

Chemical composition of all-weld metal (%) as per AWS

	C	Si	Mn	P	S	Ni	Ti	B
Example	0.08	0.31	1.32	0.007	0.004	1.33	0.020	0.0018
Guaranty	≤0.10	0.15~ 0.50	1.10~ 1.70	≤0.020	≤0.020	1.10~ 1.70	0.005~ 0.035	0.0005~ 0.0045

Mechanical properties of all-weld metal as AWS

	0.2%OS (MPa)	TS (MPa)	EI (%)	IV (J)	PWHT (°C x h)
Example	520	610	29	-80°C: 127	AW
	490	580	29	-80°C: 130	620x1
Guaranty	≥460	≥550	≥19	-60°C ≥27	AW
	≥460	≥550	≥19	-60°C ≥27	620±15x1

Recommended welding parameters

	3.2mm	4.0mm	5.0mm
F, HF, H	90~130A	130~180A	180~240A
VU, OH	80~120A	110~170A	150~200A

Polarity

Example	AC
Guaranty	AC

Approvals

LR	NV	BV	NK
5Y40m(H15)	5YH10,NV2-4L, 4-4L	4Y40MHH, MG	KMW5Y42H10

Packages

Dia. (mm)	Length (mm)	Weight per pack (kg)	Weight per carton (kg)	Weight per piece (g)
3.2	350	5	20	31
4.0	400	5	20	55
5.0	450	5	20	97

LB-62L



Extra low hydrogen and moisture resistant type covered electrode for 550 to 610MPa high tensile strength steel for low temperature service

Classification: ASME / AWS A5.5 E8016-C1

- Features :**
- Suitable for butt and fillet welding
 - Good CTOD properties at temperatures down to -10°C
 - Better impact values at temperatures down to -60°C
 - AC current is recommended for 570 to 610MPa class steel

Redrying Conditions: 350~400°Cx1h

Welding Positions:

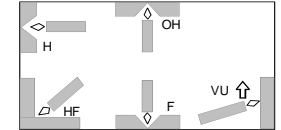

Chemical composition of all-weld metal (%) as per AWS

	C	Si	Mn	P	S	Ni	Mo	Ti	B
Example	0.07	0.34	0.97	0.012	0.005	2.10	0.13	0.022	0.0016
Guaranty	≤0.10	≤0.60	≤1.20	≤0.03	≤0.03	2.00~ 2.75	-	-	-

Mechanical properties of all-weld metal as per AWS

	0.2%OS (MPa)	TS (MPa)	EI (%)	IV (J)	PWHT (°C x h)
Example	540	650	27	-60°C: 130	AW
	530	640	28	-60°C: 120	608x1
Guaranty	≥460	≥550	≥19	-60°C ≥27	AW
	≥460	≥550	≥19	-60°C ≥27	605±15x1

Recommended welding parameters

	3.2mm	4.0mm	5.0mm
F, HF, H	90~130A	130~180A	180~240A
VU, OH	80~120A	100~170A	-

Polarity

Example	AC
Guaranty	AC, DC-EP

Approvals

Example	AB
Guaranty	5YQ500(H10)

Packages

Dia. (mm)	Length (mm)	Weight per pack(kg)	Weight per carton (kg)	Weight per piece (g)
3.2	350	5	20	31
4.0	400	5	20	55
5.0	450	5	20	97

LB-67L



Extra low hydrogen type covered electrode for 610MPa high tensile strength steel for low temperature service

Classification: ASME / AWS A5.5 E9016-G
JIS Z3211 E6216-N5M1 L

- Features :**
- Suitable for butt and fillet welding
 - Good CTOD properties at temperatures down to -20°C
 - Better impact values at temperatures down to -60°C
 - Extra low hydrogen type with excellent crack resistibility

Redrying Conditions: 350~400°Cx1h

Welding Positions:

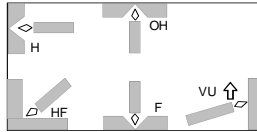

Chemical composition of all-weld metal (%) as per AWS

	C	Si	Mn	P	S	Ni	Mo
Example	0.06	0.33	1.09	0.008	0.002	2.55	0.13
Guaranty	≤0.10	0.15~0.50	0.60~1.20	≤0.020	≤0.020	2.00~2.75	≤0.3

Mechanical properties of all-weld metal as AWS

	0.2%OS (MPa)	TS (MPa)	EI (%)	IV (J)	PWHT (°Cxh)
Example	560	660	29	-60°C: 130	AW
	560	640	28	-60°C: 112	620x1
Guaranty	≥530	≥620	≥17	-60°C≥27	AW
	≥490	≥590	≥16	-60°C≥27	620±15x1

Recommended welding parameters

	2.6mm	3.2mm	4.0mm	5.0mm
F, HF, H	70~100A	80~120A	120~170	170~230A
VU, OH	65~95A	70~110A	90~160	-

Polarity

Example	DCEP
Guaranty	DCEP

Approvals

	AB
Guaranty	5YQ500 H5

Packages

Dia. (mm)	Length (mm)	Weight per pack (kg)	Weight per carton (kg)	Weight per piece (g)
2.6	300	2	20	18
3.2	350	5	20	31
4.0	400	5	20	55
5.0	450	5	20	97

LB-70L



Ultra low hydrogen and moisture resistant type covered electrode for 690MPa high tensile strength steel for low temperature service

Classification: ASME / AWS A5.5 E10016-G

- Features :**
- Suitable for butt and fillet welding
 - Good impact values at temperatures down to -60°C
 - Ultra low hydrogen type with excellent crack resistibility

Redrying Conditions: 350~430°Cx1h

Welding Positions:

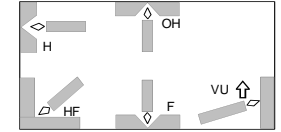

Chemical composition of all-weld metal (%) as per AWS

	C	Si	Mn	P	S	Ni	Cr	Mo
Example	0.03	0.36	1.12	0.008	0.004	3.50	0.22	0.38
Guaranty	≤0.07	0.20-0.60	0.80-1.40	≤0.020	≤0.020	3.05~3.90	0.10-0.40	0.30-0.60

Mechanical properties of all-weld metal as per AWS

	0.2%OS (MPa)	TS (MPa)	EI (%)	IV (J)
Example	685	755	27	-60°C: 108
Guaranty	≥600	≥690	≥16	-60°C≥27

Recommended welding parameters

	2.6mm	3.2mm	4.0mm	5.0mm
F, HF, H	70~100A	80~120A	120~170A	170~230A
VU, OH	65~95A	70~110A	90~160A	-

Polarity

Example	DC-EP
Guaranty	DC-EP

Approvals

	AB	NV
Guaranty	4YQ620 H5	4Y62H5

Packages

Dia. (mm)	Length (mm)	Weight per pack(kg)	Weight per carton (kg)	Weight per piece (g)
2.6	300	2	20	18
3.2	350	5	20	31
4.0	400	5	20	55
5.0	400	5	20	87

LB-80L



Ultra low hydrogen and moisture resistant type covered electrode for 780MPa high tensile strength steel for low temperature service

Classification: ASME / AWS A5.5 E11018-G H4

- Features :**
- Suitable for butt and fillet welding
 - Good impact values at temperatures down to -60°C
 - Ultra low hydrogen type with excellent crack resistibility

Redrying Conditions: 350~400°Cx1h

Welding Positions:

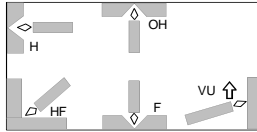

Chemical composition of all-weld metal (%) as per AWS

	C	Si	Mn	P	S	Ni	Mo
Example	0.04	0.54	1.42	0.008	0.005	3.03	0.81
Guaranty	≤0.09	0.20~0.75	1.20~1.90	≤0.020	≤0.020	2.50~3.30	0.40~1.00

Mechanical properties of all-weld metal as per AWS

	0.2%OS (MPa)	TS (MPa)	EI (%)	IV (J)
Example	735	805	24	-60°C: 77
Guaranty	≥690	≥770	≥15	-60°C≥47

Recommended welding parameters

	2.6mm	3.2mm	4.0mm	5.0mm
F, HF, H	70~100A	80~120A	120~160A	170~210A
VU, OH	65~95A	70~110A	90~150A	-

Polarity

Example	DC-EP
Guaranty	DC-EP

Approvals

AB	NV
5YQ690 H5	5Y69H5

Packages

Dia. (mm)	Length (mm)	Weight per pack(kg)	Weight per carton (kg)	Weight per piece (g)
2.6	300	2	20	18
3.2	350	5	20	32
4.0	400	5	20	57
5.0	400	5	20	90

LB-88LT



Ultra low hydrogen and moisture resistant type covered electrode for 780MPa high tensile strength steel for low temperature service

Classification: ASME / AWS A5.5 E11016-G
JIS Z3212 D8016

- Features :**
- Suitable for butt and fillet welding
 - Good impact values at temperatures down to -80°C
 - Ultra low hydrogen type with excellent crack resistibility

Redrying Conditions: 350~430°Cx1h

Welding Positions:

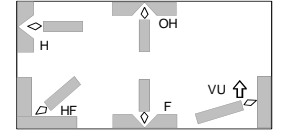

Chemical composition of all-weld metal (%) as per AWS

	C	Si	Mn	P	S	Ni	Mo
Example	0.04	0.58	1.81	0.012	0.006	2.62	0.73
Guaranty	≤0.09	0.40~0.75	1.40~2.00	≤0.020	≤0.020	2.10~2.80	0.50~0.80

Mechanical properties of all-weld metal as per AWS

	0.2%OS (MPa)	TS (MPa)	EI (%)	IV (J)
Example	750	840	20	-80°C: 63
Guaranty	≥670	≥760	≥15	-80°C≥27

Recommended welding parameters

	3.2mm	4.0mm	5.0mm
F, HF, H	90~130A	130~180A	180~240A
VU, OH	80~115A	100~170A	-

Polarity

Example	AC
Guaranty	AC

Approvals

NV
5Y69H5

Packages

Dia. (mm)	Length (mm)	Weight per pack (kg)	Weight per carton (kg)	Weight per piece (g)
3.2	350	5	20	30
4.0	400	5	20	54
5.0	400	5	20	87

Trade designation	ASME AWS Class.	Type of covering	Pol.	Features	WP	Chemical					composition of all-weld metal (%)					Mechanical properties of all-weld metal				PWHT (°Cxh)			
						C	Si	Mn	P	S	Ni	Cr	Mo	0.2%OS (MPa)	TS (MPa)	EI (%)	IV (J)						
LB-62D	A5.5 E9018-G	Low hydrogen	DC-EP	•Suitable for 550 to 610MPa high tensile strength steel •RC: 350~400°Cx1h	F	Ex	0.06	0.61	1.28	0.011	0.005	0.57	-	0.25	Ex	570	660	29	-20°C: 170	AW			
					HF	Gt	≤0.09	0.40~0.75	0.80~1.40	≤0.020	≤0.020	0.45~0.85	-	0.20~0.35	Gt	≥530	≥620	≥17	-20°C ≥27	AW			
LB-65L	A5.5 E8016-C1	Low hydrogen	DC-EP	•Suitable for 610MPa high tensile strength steel •RC: 350~400°Cx1h	F	Ex	0.06	0.33	1.09	0.008	0.002	2.55	-	0.13	Ex	560	660	29	-60°C: 130	AW			
					HF	Gt	≤0.10	≤0.60	≤1.20	≤0.03	≤0.03	2.00~2.75	-	-	Gt	≥460	≥550	≥19	-60°C ≥27	AW			
LB-106	A5.5 E10016-G	Low hydrogen	AC	•Suitable for 690MPa high tensile strength steel •RC: 350~400°Cx1h	F	Ex	0.08	0.61	1.40	0.010	0.005	1.50	0.22	0.19	Ex	660	760	25	-20°C: 110	AW			
					HF	Gt	≤0.09	0.40~0.75	1.20~1.70	≤0.020	≤0.020	1.20~1.70	0.10~0.30	0.10~0.30	Gt	≥600	≥690	≥16	-20°C ≥27	AW			
LB-116	A5.5 E11016-G	Low hydrogen	AC	•Suitable for 780MPa high tensile strength steel •RC: 350~400°Cx1h	F	Ex	0.08	0.63	1.50	0.010	0.006	1.83	0.28	0.43	Ex	730	830	24	-20°C: 110	AW			
					HF	Gt	≤0.09	0.40~0.75	1.20~1.70	≤0.020	≤0.020	1.50~2.10	0.20~0.40	0.35~0.55	Gt	≥670	≥760	≥15	-20°C ≥27	AW			
LB-80UL	A5.5 E11016-G	Low hydrogen	AC	•Suitable for 780MPa high tensile strength steel •Ultra low hydrogen type •RC: 350~430°Cx1h	F	Ex	0.08	0.52	1.50	0.009	0.006	1.90	0.28	0.43	Ex	710	820	25	-20°C: 110	AW			
					HF	Gt	≤0.09	0.35~0.70	1.30~1.80	≤0.020	≤0.020	1.70~2.10	0.10~0.40	0.25~0.55	Gt	≥670	≥760	≥15	-20°C ≥27	AW			
NB-3J	A5.5 E7016-C2L	Low hydrogen	AC	•Suitable for 3.5%Ni steel •RC: 350~400°Cx1h	F	Ex	0.04	0.26	0.66	0.006	0.003	3.44	-	-	Ex	470	560	31	-85°C: 170	AW			
					HF																		
					H																		
					VU																		
					OH	Gt	≤0.05	≤0.50	≤1.25	≤0.03	≤0.03	3.00~3.75	-	-	Gt	≥390	≥480	≥25	-101°C ≥27	AW			

Note: Welding tests are as per AWS.

Ex: Example (polarity: AC, DC-EP for LB-62D), Gt: Guaranty (polarity: as specified above)

Approvals

LB-106	AB, NK, CR
LB-116	AB, NV, NK
LB-80UL	NK, CCS

Diameter and Length (mm)

	Dia.	2.6	3.2	4.0	5.0		Dia.	2.6	3.2	4.0	5.0
LB-62D	-	350	400	400	400	LB-116	300	350	400	400	
LB-65L	-	-	400	-	-	LB-80UL	-	350	400	400	
LB-106	-	350	400	400	400	NB-3J	-	350	400	-	

DW-55E



Rutile type flux cored wire for mild steel and 490MPa high tensile strength steel for low temperature service

Classification: ASME / AWS A5.20 E71T-9C-J
EN ISO 17632-A - T 42 4 P C 1 H5
JIS Z3313 YFL-C504R

Features : •Suitable for butt and fillet welding in all positions
•Excellent impact value at low temperatures down to -40°C

Shielding gas: CO₂

Polarity: DC-EP

Welding positions:

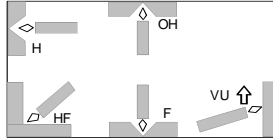

Chemical composition of all-weld metal (%) as per AWS

	C	Si	Mn	P	S	Ni
Example	0.05	0.40	1.42	0.012	0.010	0.41
Guaranty	≤0.12	≤0.90	≤1.75	≤0.03	≤0.03	≤0.50

Mechanical properties of all-weld metal as per AWS

	0.2%OS (MPa)	TS (MPa)	EI (%)	IV (J)
Example	540	590	29	-40°C: 80
Guaranty	≥400	≥480	≥22	-40°C≥27

Recommended welding parameters

	Dia.	1.2mm	1.4mm
F	150~300A	150~400A	
HF	150~300A	150~350A	
H	150~280A	150~300A	
VU, OH	150~250A	150~250A	

Approvals

AB	LR	NV	BV	NK	Others
3SA, 3Y400SA(H5)	4Y40S(H5)	ⅢYMS(H5)	SA3,SA3YM HHH	KSW54Y40G (C)H5	GL, CR

Packages

Dia. (mm)	Type	Weight (kg)	Dia. (mm)	Type	Weight (kg)
1.2	Spool	12.5	1.4	Spool	15
	Spool	15		Spool	20
	Spool	20			

DW-A55E



Rutile type flux cored wire for mild steel and 490MPa high tensile strength steel for low temperature service

Classification: ASME / AWS A5.20 E71T-9M-J
EN ISO 17632-A - T 42 4 P M 1 H5
JIS Z3313 YFL-C504R

Features : •Suitable for butt and fillet welding in all positions
•Excellent impact value at low temperatures down to -40°C

Shielding gas: 80%Ar+20%CO₂ mixture

Polarity: DC-EP

Welding positions:

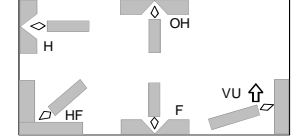

Chemical composition of all-weld metal (%) as per AWS

	C	Si	Mn	P	S	Ni
Example	0.05	0.54	1.31	0.013	0.009	0.34
Guaranty	≤0.12	≤0.90	≤1.75	≤0.03	≤0.03	≤0.50

Mechanical properties of all-weld metal as per AWS

	0.2%OS (MPa)	TS (MPa)	EI (%)	IV (J)
Example	540	600	28	-40°C: 100
Guaranty	≥400	≥480	≥22	-40°C≥27

Recommended welding parameters

	Dia.	1.2mm
F	150~300A	
HF	150~300A	
H	150~280A	
VU, OH	150~250A	

Approvals

AB	LR	NV	BV	Others
4Y400SA(H5)	4Y40S(H5)	ⅣYMS(H5)	SA3YM HHH	GL, TÜV, U(ic)

Packages

Dia. (mm)	Type	Weight (kg)
1.2	Spool	12.5
	Spool	15

DW-50LSR

TRUSTARC™

Rutile type flux cored wire for mild steel and 490MPa high tensile strength steel for low temperature service

Classification : ASME / AWS A5.29 E71T1-GC
JIS Z 3313 T496T1-1CA-N1

Features : •Suitable for butt and fillet welding in all positions
•Excellent impact value at low temperatures down to -60°C in the as-welded condition and down to -50°C in the PWHT condition

Shielding gas: CO₂
Polarity: DC-EP

Welding positions:

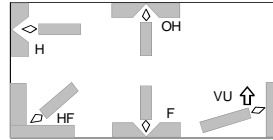

■ **Chemical composition of all-weld metal (%) as per AWS**

	C	Si	Mn	P	S	Ni
Example	0.07	0.25	1.28	0.009	0.007	0.85
Guaranty	≤0.12	≤0.80	0.50~1.75	≤0.030	≤0.030	0.70~1.00

■ **Mechanical properties of all-weld metal as per AWS**

	0.2%OS (MPa)	TS (MPa)	EI (%)	IV (J)	PWHT (°C×h)
Example	480	560	31	-60°C: 111	AW
	425	520	35	-60°C: 111	620x1
Guaranty	≥400	490~621	≥20	-60°C≥47	AW

■ **Recommended welding parameters**

Dia.	1.2mm
F	150~300A
HF	150~300A
H	150~280A
VU, OH	150~250A

■ **Packages**

Dia. (mm)	Type	Weight (kg)
1.2	Spool	12.5
	Spool	15
	Spool	20

DW-A81Ni1

TRUSTARC™

Rutile type flux cored wire for mild steel and 490-550MPa high tensile strength steel for low temperature service

Classification : ASME / AWS A5.29 E81T1-Ni1M-J
EN ISO 17632-A - T 46 6 1Ni P M 2 H5

Features : •Suitable for butt and fillet welding in all positions
•Excellent impact value at low temperatures down to -60°C

Shielding gas: 80%Ar-20%CO₂ mixture
Polarity: DC-EP

Welding positions:

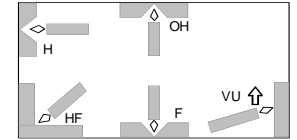

■ **Chemical composition of all-weld metal (%) as per AWS**

	C	Si	Mn	P	S	Ni
Example	0.05	0.32	1.26	0.006	0.006	0.95
Guaranty	≤0.12	≤0.80	≤1.50	≤0.03	≤0.03	0.80~1.10

■ **Mechanical properties of all-weld metal as per AWS**

	0.2%OS (MPa)	TS (MPa)	EI (%)	IV (J)
Example	520	580	29	-60°C: 142
Guaranty	≥470	550~690	≥19	-60°C≥27

■ **Recommended welding parameters**

Dia.	1.2mm
F	150~300A
HF	150~300A
H	150~280A
VU, OH	150~250A

■ **Approvals**

AB	LR	NV	Others
5YQ420SA(H5) 4Y400SA(H5)	5Y42S(H5)	V Y42MS(H5), NV2-4L, 4-4L	CWB

■ **Packages**

Dia. (mm)	Type	Weight (kg)
1.2	Spool	15

DW-55L



Rutile type flux cored wire for mild steel and 490-550MPa high tensile strength steel for low temperature service

Classification : ASME / AWS A5.29 E81T1-K2C
 EN ISO 17632-A - T 46 6 1.5Ni P C 1 H5
 JIS Z3313 YFL-C506R

Features : •Suitable for butt and fillet welding in all positions
 •Excellent impact value at low temperatures down to -60°C

Shielding gas : CO₂

Polarity : DC-EP

Welding positions:

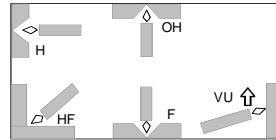

Chemical composition of all-weld metal (%) as per AWS

	C	Si	Mn	P	S	Ni
Example	0.04	0.38	1.32	0.010	0.008	1.40
Guaranty	≤0.15	≤0.80	0.50~1.75	≤0.03	≤0.03	1.00~2.00

Mechanical properties of all-weld metal as per AWS

	0.2%OS (MPa)	TS (MPa)	EI (%)	IV (J)
Example	550	620	27	-60°C: 70
Guaranty	≥470	550~690	≥22	-60°C ≥27

Recommended welding parameters

	1.2mm	1.4mm
Dia.	1.2mm	1.4mm
F	150~300A	150~400A
HF	150~300A	150~350A
H	150~280A	150~300A
VU, OH	150~250A	150~250A

Approvals

AB	LR	NV	BV	NK	Others
3SA,4Y400SA, MG	5Y40S(H15)	V YMS(H10), NV2-4,4-4	SA3YM(HH), MG	KSWL3G(C)	GL, CCS, KR

Packages

Dia. (mm)	Type	Weight (kg)	Dia. (mm)	Type	Weight (kg)
1.2	Spool	12.5	1.4	Spool	12.5
	Spool	15		Spool	15
	Spool	20			

DW-A55L



Rutile type flux cored wire for mild steel and 490-550MPa high tensile strength steel for low temperature service

Classification: ASME / AWS A5.29 E81T1-K2M
 EN ISO 17632-A - T 46 6 1.5Ni P M 1 H5

Features : •Suitable for butt and fillet welding in all positions
 •Excellent impact value at low temperatures down to -60°C

Shielding gas: 80%Ar-20%CO₂ mixture

Polarity: DC-EP

Welding positions:

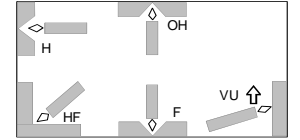

Chemical composition of all-weld metal (%) as per AWS

	C	Si	Mn	P	S	Ni
Example	0.06	0.30	1.15	0.009	0.007	1.41
Guaranty	≤0.15	≤0.80	0.50~1.75	≤0.03	≤0.03	1.00~2.00

Mechanical properties of all-weld metal as per AWS

	0.2%OS (MPa)	TS (MPa)	EI (%)	IV (J)
Example	560	630	27	-60°C: 94
Guaranty	≥470	550~690	≥22	-60°C ≥27

Recommended welding parameters

	1.2mm
Dia.	1.2mm
F	150~300A
HF	150~300A
H	150~280A
VU, OH	150~250A

Approvals

AB	LR	NV
3SA,3YSA, MG	5Y46S(H5)	V Y46MS(H5), NV2-4,4-4

Packages

Dia. (mm)	Type	Weight (kg)
1.2	Spool	15

DW-55LSR



Rutile type flux cored wire for mild steel and 490-550MPa high tensile strength steel for low temperature service

Classification: ASME / AWS A5.29 E81T1-K2C
EN ISO 17632-A - T 46 6 1.5Ni P C 1 H5
JIS Z3313 YFL-C506R

Features : •Suitable for butt and fillet welding in all positions
•Excellent impact value at low temperatures down to -60°C in the as-welded and PWHT conditions

Shielding gas: CO₂
Polarity: DC-EP

Welding positions:

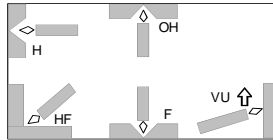

Chemical composition of all-weld metal (%) as per AWS

	C	Si	Mn	P	S	Ni
Example	0.06	0.26	1.15	0.008	0.007	1.51
Guaranty	≤0.15	≤0.80	0.50~1.75	≤0.03	≤0.03	1.00~2.00

Mechanical properties of all-weld metal as per AWS

	0.2%OS (MPa)	TS (MPa)	EI (%)	IV (J)	PWHT (°C×h)
Example	480	565	33	-60°C: 115	AW
	440	530	34	-60°C: 100	620X1
Guaranty	≥470	550~690	≥22	-60°C ≥27	AW

Recommended welding parameters

Dia.	1.2mm
F	150~300A
HF	150~300A
H	150~280A
VU, OH	150~250A

Approvals

AB	LR	NV	BV	NK
5YQ420SA(H5) 4Y400SA(H5)	5Y42S, 5Y42srS(H10), MG	VY42MS(H10), MG NV2-4L, 4-4L	SA4Y40M HH, MG	KSW5Y42G(C)H10, MG

Packages

Dia. (mm)	Type	Weight (kg)
1.2	Spool	12.5
	Spool	15

DW-A55LSR



Rutile type flux cored wire for mild steel and 490-550MPa high tensile strength steel for low temperature service

Classification: ASME / AWS A5.29 E81T1-Ni1M
EN ISO 17632-A - T 46 6 Z P M 1 H5

Features : •Suitable for butt and fillet welding in all positions
•Excellent impact value at low temperatures down to -60°C in the as-welded and PWHT conditions

Shielding gas: 80%Ar-20%CO₂ mixture
Polarity: DC-EP

Welding positions:

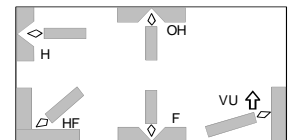

Chemical composition of all-weld metal (%) as per AWS

	C	Si	Mn	P	S	Ni
Example	0.05	0.33	1.32	0.009	0.008	0.90
Guaranty	≤0.12	≤0.80	≤1.50	≤0.03	≤0.03	0.80~1.10

Mechanical properties of all-weld metal as per AWS

	0.2%OS (MPa)	TS (MPa)	EI (%)	IV (J)	PWHT (°C×h)
Example	510	570	29	-60°C: 120	AW
	450	530	33	-60°C: 70	620x2
Guaranty	≥470	550~690	≥22	-60°C ≥27	AW

Recommended welding parameters

Dia.	1.2mm
F	150~300A
HF	150~300A
H	150~280A
VU, OH	150~250A

Approvals

AB	LR	NV
5YQ420SA(H5)	5Y42S(H5)	VY42MS(H5), NV2-4L, 4-4L

Packages

Dia. (mm)	Type	Weight (kg)
1.2	Spool	15

DW-62L



Rutile type flux cored wire for 550-620 MPa high tensile strength steel for low temperature service

Classification: ASME / AWS A5.29 E91T1-Ni2C-J
EN ISO 17632-A - T 50 6 Z P C 2 H5

Features : •Suitable for butt and fillet welding in all positions
•Excellent impact value at low temperatures down to -60°C
•Excellent CTOD value at low temperatures down to -40°C

Shielding gas: CO₂

Polarity: DC-EP

Welding positions:

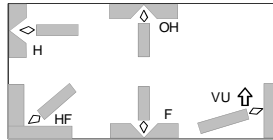

Chemical composition of all-weld metal (%) as per AWS

	C	Si	Mn	P	S	Ni
Example	0.06	0.29	1.23	0.007	0.008	2.5
Guaranty	≤0.12	≤0.80	≤1.50	≤0.03	≤0.03	1.75~2.75

Mechanical properties of all-weld metal as per AWS

	0.2%OS (MPa)	TS (MPa)	EI (%)	IV (J)	PWHT (°C×h)
Example	580	650	25	-60°C: 93	AW
Guaranty	≥540	620~760	≥17	-60°C≥27	AW

Recommended welding parameters

Dia.	1.2mm
F	150~300A
HF	150~300A
H	150~280A
VU, OH	150~250A

Packages

Dia. (mm)	Type	Weight (kg)
1.2	Spool	12.5

DW-A62L



Rutile type flux cored wire for mild steel and 550-620MPa high tensile strength steel for low temperature service

Classification: ASME / AWS A5.29 E91T1-GM
EN ISO 17632-A - T 50 6 Z P M 2 H5

Features : •Suitable for butt and fillet welding in all positions
•Excellent impact value at low temperatures down to -60°C
•Excellent CTOD value at low temperatures down to -40°C

Shielding gas: 80%Ar-20%CO₂ mixture

Polarity: DC-EP

Welding positions:

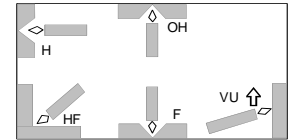

Chemical composition of all-weld metal (%) as per AWS

	C	Si	Mn	P	S	Ni
Example	0.07	0.32	1.33	0.007	0.011	2.1
Guaranty	≤0.12	≤0.80	≤1.50	≤0.03	≤0.03	1.75~2.75

Mechanical properties of all-weld metal as per AWS

	0.2%OS (MPa)	TS (MPa)	EI (%)	IV (J)
Example	560	640	27	-60°C: 82
Guaranty	≥540	620~760	≥17	-60°C≥27

Recommended welding parameters

Dia.	1.2mm
F	150~300A
HF	150~300A
H	150~280A
VU, OH	150~250A

Packages

Dia. (mm)	Type	Weight (kg)
1.2	Spool	12.5

DW-A65L



Rutile type flux cored wire for 550-620MPa high tensile strength steel for low temperature service

Classification: ASME / AWS A5.29 E91T1-K2M-J
EN ISO 18276-A-T55 4 Z P M 2 H5

Features : •Suitable for butt and fillet welding in all positions
•Excellent impact value at low temperatures down to -40°C

Shielding gas: 80%Ar-20%CO₂ mixture

Polarity: DC-EP

Welding positions:

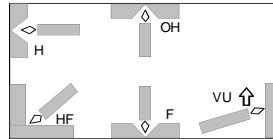

Chemical composition of all-weld metal (%) as per AWS

	C	Si	Mn	P	S	Ni	Mo
Example	0.05	0.32	1.18	0.009	0.008	1.78	0.11
Guaranty	≤0.15	≤0.80	0.50~1.75	≤0.03	≤0.03	1.00~2.00	≤0.35

Mechanical properties of all-weld metal as per AWS

	0.2%OS (MPa)	TS (MPa)	EI (%)	IV (J)
Example	600	660	25	-40°C: 80
Guaranty	≥540	620~760	≥17	-40°C ≥27

Recommended welding parameters

Dia.	1.2mm
F	150~300A
HF	150~300A
H	150~280A
VU, OH	150~250A

Packages

Dia. (mm)	Type	Weight (kg)
1.2	Spool	15

MX-A55Ni1



Metal cored wire for mild steel and 490-550MPa high tensile strength steel for low temperature service

Classification: ASME / AWS A5.28 E80C-G
EN ISO 17632-A - T46 6 Mn1Ni M M 3 H5

Features : •Suitable for butt and fillet welding
•Excellent impact value at low temperatures down to -60°C

Shielding gas: 80%Ar-20%CO₂ mixture

Polarity: DC-EP

Welding positions:

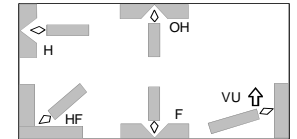

Chemical composition of all-weld metal (%) as per AWS

	C	Si	Mn	P	S	Ni
Example	0.05	0.34	1.67	0.007	0.008	0.86
Guaranty	≤0.15	≤0.80	1.40~2.00	≤0.030	≤0.030	1.70~1.00

Mechanical properties of all-weld metal as per AWS

	0.2%OS (MPa)	TS (MPa)	EI (%)	IV (J)
Example	540	610	29	-60°C: 120
Guaranty	≥470	550~680	≥20	-60°C ≥47

Recommended welding parameters

Dia.	1.2mm
F	150~300A
HF	150~300A
H	150~300A

Packages

Dia. (mm)	Type	Weight (kg)
1.2	Spool	15

MX-A80L

TRUSTARC™

Metal cored wire for 780MPa high tensile strength steel for low temperature service

Classification: ASME / AWS A5.28 E110C-G H4
EN 12535 T69 6 Mn2.5Ni M M 3 H5

Features : •Suitable for butt and fillet welding
•Excellent impact value at low temperatures down to -60°C

Shielding gas: 80%Ar-20%CO₂ mixture

Polarity: DC-EP

Welding positions:

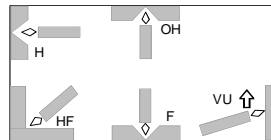

■ **Chemical composition of all-weld metal (%) as per AWS**

	C	Si	Mn	P	S	Ni	Mo
Example	0.06	0.48	1.87	0.008	0.010	2.37	0.09
Guaranty	0.03~0.10	≤0.90	1.1~2.0	≤0.019	≤0.0019	2.1~3.0	≤0.1

■ **Mechanical properties of all-weld metal as per AWS**

	0.2%OS (MPa)	TS (MPa)	EI (%)	IV (J)
Example	720	800	24	-60°C: 120
Guaranty	≥690	770~940	≥17	-60°C ≥47

■ **Recommended welding parameters**

Dia.	1.2mm
F	150~300A
HF	150~300A
H	150~300A

■ **Packages**

Dia. (mm)	Type	Weight (kg)
1.2	Spool	12.5

Flux Cored Wires for Low Temperature Steel



Trade designation	ASME AWS Class.	Type of cored flux	SG	Pol.	Features	WP	Chemical		composition of all-weld metal (%)					Mechanical properties of all-weld metal									
							C	Si	Mn	P	S	Ni	0.2%OS (MPa)	TS (MPa)	EI (%)	IV (J)	PWHT (°Cxh)						
DW-A55ESR	A5.20 E71T -12M-J	Rutile	80%Ar- 20%CO ₂	DC- EP	<ul style="list-style-type: none"> Suitable for butt and fillet welding in all positions Excellent impact value at low temperatures down to -40°C in the as-welded and PWHT conditions 	F HF H VU OH	Ex	0.05	0.50	1.40	0.013	0.007	0.40	Ex	500	580	30	-40°C: 130	AW				
MX-55LF	A5.20 E70T -9C-J	Metal	CO ₂	DC- EP	<ul style="list-style-type: none"> Suitable for flat and horizontal fillet welding Excellent porosity resistibility to inorganic zinc primer Excellent impact value at low temperatures down to -60°C 	F HF	Ex	0.05	0.44	1.42	0.012	0.007	0.34	Ex	540	590	29	-60°C: 58	-				
MX-A55T	A5.28 E80C -G	Metal	80%Ar- 20%CO ₂	DC- EP	<ul style="list-style-type: none"> Suitable for butt and fillet welding in all positions with a short circuit arc Excellent impact value at low temperatures down to -60°C 	F HF H VU OH	Ex	0.05	0.34	1.40	0.013	0.018	1.42	Ex	540	600	29	-60°C: 90	-				

Note: Welding tests are as per AWS. Ex: Example, Gt: Guaranty

Approvals

DW-A55ESR	AB, CWB
MX-55LF	AB, LR, NV, BV, NK
MX-A55T	LR, NV, BV

Diameter (mm)

DW-A55ESR	1.2, 1.6
MX-55LF	1.2, 1.4, 1.6
MX-A55T	1.2, 1.4

Trade designation	ASME AWS Class.	SG	Pol.	Features	WP	Chemical			composition of wire (%)						Mechanical properties of all-weld metal						
						C	Si	Mn	P	S	Ni	Cr	Mo	Cu	0.2%OS (MPa)	TS (MPa)	EI (%)	IV (J)	PWHT (°CX h) & SG		
MG-60	A5.28 ER80S -G	CO ₂	DC-EP	•Suitable for flat, horizontal and horizontal fillet welding	F HF H	Ex	0.04	0.85	1.95	0.007	0.010	Al: 0.01	Ti+Zr: 0.20	0.32	0.23	Ex	590	670	28	-18°C: 90	AW
						Gt	≤0.12	0.60~1.00	1.65~2.15	≤0.025	≤0.025	Al: ≤0.10	Ti+Zr: ≤0.30	0.20~0.50	≤0.50	Gt	≥470	≥550	≥19	-18°C: ≥27	AW
MG-S63B	A5.28 ER90S -G	Ar-5~25% CO ₂	DC-EP	•Suitable for 550 to 610MPa high tensile strength steel	F HF H VU OH	Ex	0.09	0.69	1.36	0.004	0.007	0.05	0.45	0.28	0.21	Ex	580	660	29	-18°C: 150	AW 80%Ar-20%CO ₂
						Gt	≤0.12	0.40~0.90	1.00~1.50	≤0.025	≤0.025	≤0.20	0.20~0.60	0.20~0.50	≤0.50	Gt	≥490	≥620	≥19	-18°C: ≥27	AW 80%Ar-20%CO ₂
MG-70	A5.28 ER100S -G	CO ₂	DC-EP	•Suitable for 690MPa high tensile strength steel	F HF H	Ex	0.08	0.78	2.00	0.008	0.007	1.05	0.03	0.64	0.23	Ex	610	720	26	-18°C: 90	AW
						Gt	≤0.12	0.50~1.00	1.70~2.30	≤0.030	≤0.030	0.70~1.50	≤0.30	0.40~0.90	≤0.35	Gt	≥550	≥690	≥16	-18°C: ≥27	AW
MG-S70	A5.28 ER100S -G	Ar-5~25% CO ₂	DC-EP	•Suitable for 690MPa high tensile strength steel	F HF H VU OH	Ex	0.08	0.47	1.41	0.006	0.008	2.02	0.17	0.39	0.21	Ex	650	720	25	-40°C: 100	AW 80%Ar-20%CO ₂
						Gt	≤0.11	0.30~0.80	0.90~1.60	≤0.030	≤0.030	1.50~2.50	≤0.30	0.20~0.60	≤0.50	Gt	≥550	≥690	≥16	-40°C: ≥27	AW 80%Ar-20%CO ₂

Note: Welding tests are as per AWS . Ex: Example, Gt: Guaranty

Approvals

MG-60 NV, NK

Diameter (mm)

MG-60 0.9, 1.2, 1.4, 1.6 MG-70 1.2, 1.6

MG-S63B 1.2, 1.6 MG-S70 1.2

Solid wires for 780MPa High Tensile Strength Steel and Low Temperature Steel

Trade designation	ASME AWS Class.	SG	Pol.	Features	WP	Chemical composition of wire (%)										Mechanical properties of all-weld metal					
						C	Si	Mn	P	S	Ni	Cr	Mo	Cu	0.2%OS (MPa)	TS (MPa)	EI (%)	IV (J)	PWHT & SG		
MG-80	A5.28 ER110S -G	CO ₂	DC-EP	*Suitable for 780MPa high tensile strength steel	F HF H	Ex	0.08	0.67	1.88	0.008	0.009	2.16	-	0.65	0.23	Ex	680	800	22	-18°C: 85	AW
						Gt	≤0.12	0.40~0.90	1.60~2.20	≤0.030	≤0.030	1.80~2.60	-	0.40~0.90	≤0.35	Gt	≥590	≥760	≥15	-18°C ≥27	AW
MG-S80	A5.28 ER110S -G	Ar-5~25% CO ₂	DC-EP	*Suitable for 780MPa high tensile strength steel	F HF H VU OH	Ex	0.08	0.46	1.37	0.007	0.002	2.64	0.19	0.50	0.22	Ex	770	850	20	-40°C: 80	AW 80%Ar-20%CO ₂
						Gt	≤0.12	0.30~0.60	1.10~1.60	≤0.030	≤0.030	2.40~3.00	0.10~0.40	0.30~0.70	≤0.35	Gt	≥665	≥760	≥15	-40°C ≥27	AW 80%Ar-20%CO ₂
MG-S88A	A5.28 ER120S -G	80%Ar-20% CO ₂	DC-EP	*Suitable for 780MPa high tensile strength steel for low temperature service	F HF H VU OH	Ex	0.06	0.50	1.59	0.005	0.005	3.56	-	0.78	0.18	Ex	770	880	22	-80°C: 78	AW 80%Ar-20%CO ₂
						Gt	≤0.09	0.30~0.70	1.30~1.70	≤0.020	≤0.020	3.20~3.80	-	0.60~0.90	≤0.50	Gt	≥690	≥830	≥15	-60°C ≥27	AW 80%Ar-20%CO ₂

Note: Welding tests are as per AWS. Ex: Example, Gt: Guaranty

Approvals

MG-S80 AB, NV, NK, GL

Diameter (mm)

MG-80 1.2, 1.6
 MG-S80 1.2, 1.6
 MG-S88A 1.2

Solid wires for Low Temperature Steel

Trade designation	ASME AWS Class.	SG	Pol.	Features	WP	Chemical			composition of wire (%)					Mechanical properties of all-weld metal						
						C	Si	Mn	P	S	Ni	Others	Cu	0.2%OS (MPa)	TS (MPa)	EI (%)	IV (J)	PWHT (°C×h) & SG		
MG-S50LT	A5.18 ER70S-G	80%Ar-20%CO ₂	DC-EP	•Suitable for 400 to 490 high tensile strength steel for low temperature service •Ti-B type weld metal	F HF H VU OH	Ex	0.09	0.39	1.91	0.006	0.003	0.03	Ti: 0.08 B: 0.006	0.22	Ex	470	540	33	-60°C: 110	AW
						Gt	0.03~0.10	0.30~0.50	1.50~2.10	≤0.015	≤0.015	≤0.50	Ti: 0.04~0.12 B: 0.003~0.010	≤0.40	Gt	≥400	≥480	≥22	-60°C: ≥27	620x1
MG-S1N	A5.28 ER70S-G	Ar-5~20%CO ₂	DC-EP	•Suitable for low temperature steel	F HF H VU OH	Ex	0.04	0.43	1.30	0.005	0.006	1.76	Mo: 0.21	0.21	Ex	410	520	32	-60°C: 140	620x1 80%Ar-20%CO ₂
						Gt	≤0.07	0.20~0.60	1.00~1.60	≤0.020	≤0.020	1.50~2.00	Mo ≤0.40	≤0.50	Gt	≥360	≥480	≥22	-60°C: ≥27	620±15x1 80%Ar-20%CO ₂
MG-S3N	A5.28 ER70S-G	Ar-5~20%CO ₂	DC-EP	•Suitable for 3.5% Ni steel	F HF H VU OH	Ex	0.03	0.26	1.18	0.007	0.003	4.14	Mo: 0.22	0.22	Ex	470	570	32	-101°C: 130	620x1 95%Ar-5%CO ₂
						Gt	≤0.07	≤0.50	1.00~1.50	≤0.020	≤0.020	3.80~4.50	Mo ≤0.40	≤0.50	Gt	≥360	≥480	≥16	-105°C: ≥27	620±15x1 95%Ar-5%CO ₂

Note: Welding tests are as per AWS. Ex: Example, Gt: Guaranty

Approvals

MG-S50LT AB, LR, NV, NK

Diameter (mm)

MG-S50LT 1.2, 1.6

MG-S1N 1.2, 1.6

MG-S3N 1.2, 1.6

Trade designation	ASME AWS Class.	SG	Pol.	Features		Chemical composition of rod and wire (%)					Mechanical properties of all-weld metal												
						C	Si	Mn	P	S	Ni	Mo	Others	Cu	YP (MPa)	TS (MPa)	EL (%)	IV (J)	PWHT (°Cxh)				
TG-S62	A5.28 ER80S -G	Ar	DC-EN	•Suitable for 550 to 590MPa high tensile strength steel	Ex	0.08	0.74	1.38	0.007	0.009	0.02	0.51	-	0.12	Ex	480	630	28	-20°C: 180	AW			
					Gt	≤0.10	0.30~0.85	1.15~1.65	≤0.020	≤0.020	≤0.60	0.25~0.65	-	≤0.50	Gt	≥420	≥550	≥18	-20°C: ≥27	620 x1			
TG-S60A	A5.28 ER80S -G	Ar	DC-EN	•Suitable for 550 to 610MPa high tensile strength steel	Ex	0.09	0.05	1.36	0.007	0.007	1.00	0.58	-	0.12	Ex	590	670	28	-45°C: 180	AW			
					Gt	≤0.12	≤0.20	1.00~1.60	≤0.025	≤0.025	0.60~1.20	0.30~0.65	-	≤0.50	Gt	≥420	≥550	≥18	-60°C: ≥27	585 x15			
TG-S80AM	A5.28 ER110S -G	Ar	DC-EN	•Suitable for 780MPa high tensile strength steel	Ex	0.09	0.11	1.24	0.006	0.008	2.89	0.69	Cr: 0.36	0.21	Ex	760	880	23	-60°C: 240	AW			
					Gt	≤0.12	≤0.20	0.90~1.40	≤0.025	≤0.025	2.60~3.20	0.40~0.90	Cr: 0.10~0.60	≤0.50	Gt	≥665	≥760	≥15	-60°C: ≥27	AW			

Note: Welding tests are as per AWS. Ex: Example, Gt: Guaranty

■ Diameter (mm)

TG-S62	1.2, 1.6, 2.0, 2.4
TG-S60A	1.2, 1.6, 2.0, 2.4
TG-S80AM	1.2, 1.6, 2.0, 2.4

TIG Welding Rods and Wires for Low Temperature Steel



Trade designation	ASME AWS Class.	SG	Pol.	Features	Chemical composition of rod and wire (%)										Mechanical properties of all-weld metal							
					C	Si	Mn	P	S	Ni	Mo	Cu	YP (MPa)	TS (MPa)	EL (%)	IV (J)	PWHT (°C x h)					
TG-S1N	A5.28 ER70S-G	Ar	DC-EN	•Suitable for low temperature steel	Ex	0.05	0.31	1.07	0.005	0.007	0.82	0.15	0.12	Ex	460	540	33	-60°C: 200	AW			
					Gt	≤0.09	≤0.60	0.70~1.30	≤0.025	≤0.025	0.60~1.00	≤0.30	≤0.40	Gt	≥360	≥480	≥24	-60°C: ≥27	AW			
TG-S3N	A5.28 ER70S-G	Ar	DC-EN	•Suitable for 3.5% Ni steel	Ex	0.04	0.36	0.89	0.004	0.007	3.48	0.15	0.11	Ex	510	580	30	-101°C: 69	AW			
					Gt	≤0.06	≤0.60	0.60~1.10	≤0.020	≤0.020	3.20~3.90	≤0.30	≤0.50	Gt	≥360	≥480	≥24	-105°C: ≥27	AW			

Note: Welding tests are as per AWS. Ex: Example, Gt: Guaranty

Approvals

TG-S1N	AB, LR, NV, BV, NK, GL
--------	------------------------

Diameter (mm)

TG-S1N	1.6, 2.0, 2.4
TG-S3N	1.6, 2.0, 2.4

FAMILIARC™ MF-38 / TRUSTARC™ US-49

SAW flux and wire combination for 550 to 590MPa high tensile strength steel

Classification: ASME / AWS A5.23 F8A4-EG-A4
F8P6-EG-A4

JIS Z3183 S584-H

Features : •Suitable for butt and fillet welding
•Applicable for 0.5%Mo steel

Redrying conditions of flux: 150~350°Cx1h

Chemical composition of wire (%) as per AWS

	C	Si	Mn	P	S	Mo	Cu
Example	0.09	0.03	1.58	0.014	0.013	0.52	0.10
Guaranty	0.07~ 0.12	≤0.05	1.25~ 1.80	≤0.025	≤0.025	0.45~ 0.60	≤0.35

Chemical composition of weld metal (%) as per AWS

	C	Si	Mn	P	S	Mo	Cu
Example	0.10	0.37	1.35	0.014	0.014	0.53	-
Guaranty	≤0.15	≤0.80	≤1.60	≤0.030	≤0.030	0.40~ 0.65	≤0.35

Mechanical properties of weld metal as per AWS

	0.2%OS (MPa)	TS (MPa)	EI (%)	IV (J)	PWHT (°C×h)
Example	520	640	28	-40°C: 37	AW
	510	600	29	-51°C: 40	600x3
Guaranty	≥470	550~690	≥20	-40°C≥27	AW
	≥470	550~690	≥20	-51°C≥27	620±15x1

Polarity

Example	AC
Guaranty	AC

Approvals (Single)

AB	LR	NV	BV	NK	Others
3YTM	3T,3YM,3YT	IIIYTM	A3YTM	KAW3Y46TM H10	CCS

Packages

Wire		
Dia. (mm)	Type	Weight (kg)
1.6	spool	10,20
2.0	spool	10,20
2.4	coil	25
	spool	10,20
3.2	coil	25,76
4.0	coil	25, 75
4.8	coil	25,75
6.4	coil	25

Flux		
Mesh size	Type	Weight (kg)
12x65	can	25
20x200	can	25
20xD	can	25

FAMILIARC™ MF-38 / TRUSTARC™ US-A4**SAW flux and wire combination for 550 to 590MPa high tensile strength steel**

Classification : ASME / AWS A5.23 F8A4-EA4-A4
F8P6-EA4-A4

JIS Z3183 S584-H

Features : •Suitable for butt and fillet welding
•Applicable for 0.5%Mo steel

Redrying conditions of flux: 150~350°Cx1h

Chemical composition of wire (%) as per AWS

	C	Si	Mn	P	S	Mo	Cu
Example	0.09	0.04	1.59	0.010	0.014	0.52	0.10
Guaranty	0.05~ 0.15	≤0.20	1.20~ 1.70	≤0.025	≤0.025	0.45~ 0.65	≤0.35

Chemical composition of weld metal (%) as per AWS

	C	Si	Mn	P	S	Mo	Cu
Example	0.10	0.39	1.35	0.013	0.013	0.52	0.11
Guaranty	≤0.15	≤0.80	≤1.60	≤0.030	≤0.030	0.40~ 0.65	≤0.35

Mechanical properties of weld metal as per AWS

	0.2%OS (MPa)	TS (MPa)	EI (%)	IV (J)	PWHT (°C×h)
Example	520	640	28	-40°C: 37	AW
	510	600	29	-51°C: 40	620x1
Guaranty	≥470	550~690	≥20	-40°C≥27	AW
	≥470	550~690	≥20	-51°C≥27	620±15x1

Polarity

Example	AC
Guaranty	AC

Packages

Wire	Dia. (mm)	Type	Weight (kg)
	3.2	coil	25
	4.0	coil	25
	4.8	coil	25

Flux	Mesh size	Type	Weight (kg)
	12x65	can	25
	20x200	can	25
	20xD	can	25

FAMILIARC™ MF-38 / TRUSTARC™ US-40**SAW flux and wire combination for 550 to 610MPa high tensile strength steel**

Classification : ASME / AWS A5.23 F9A6-EA3-A3
F8P6-EA3-A3

JIS Z3183 S624-H1

Features : •Suitable for butt and fillet welding
•Applicable for 0.5%Mo steel

Redrying conditions of flux: 150~350°Cx1h

Chemical composition of wire (%) as per AWS

	C	Si	Mn	P	S	Mo	Cu
Example	0.13	0.04	1.80	0.008	0.010	0.52	0.12
Guaranty	0.05~ 0.17	≤0.20	1.65~ 2.20	≤0.025	≤0.025	0.45~ 0.65	≤0.35

Chemical composition of weld metal (%) as per AWS

	C	Si	Mn	P	S	Mo	Cu
Example	0.08	0.34	1.58	0.017	0.009	0.45	0.12
Guaranty	≤0.15	≤0.80	≤2.10	≤0.030	≤0.030	0.40~0.65	≤0.35

Mechanical properties of weld metal as per AWS

	0.2%OS (MPa)	TS (MPa)	EI (%)	IV (J)	PWHT (°C×h)
Example	580	670	28	-51°C: 51	AW
	560	630	29	-51°C: 58	620X1
Guaranty	≥540	620~760	≥17	-51°C≥27	AW
	≥470	550~690	≥20	-51°C≥27	620±15x1

Polarity

Example	AC
Guaranty	AC

Approvals

	AB	NK
Single	MG	KAW3Y50MH10

Packages

Wire	Dia. (mm)	Type	Weight (kg)
	2.0	spool	20
	2.4	coil	25
	3.2	coil	25,75,150
	4.0	coil	25,75
	4.8	coil	25,75,150
	6.4	coil	25

Flux	Mesh size	Type	Weight (kg)
	12x65	can	25
	20x200	can	25
	20xD	can	25

PF-H80AK/US-80LT

TRUSTARC™

SAW flux and wire combination for 780MPa high tensile strength steel

Classification: ASME / AWS A5.23 F12A10-EG-G

Features : •Suitable for butt and flat fillet welding of heavy duty structures

•AC current is only applicable

•Excellent impact value at low temperatures down to -80°C

Redrying conditions of flux: 250~350°Cx1h

Chemical composition of wire (%) as per AWS

	C	Si	Mn	P	S	Ni	Mo	Cu
Example	0.12	0.15	2.03	0.007	0.002	2.75	0.77	0.10
Guaranty	≤0.15	≤0.25	1.75~ 2.25	≤0.015	≤0.015	2.40~ 2.90	0.60~ 0.90	≤0.40

Chemical composition of weld metal (%) as per AWS

	C	Si	Mn	P	S	Ni	Mo	Cu
Example	0.08	0.28	1.65	0.009	0.004	2.45	0.74	0.12
Guaranty	≤0.12	≤0.80	1.20~ 2.20	≤0.030	≤0.030	2.10~ 2.90	0.50~ 1.00	≤0.35

Mechanical properties of weld metal as per AWS

	0.2%OS (MPa)	TS (MPa)	EI (%)	IV (J)	PWHT
Example	760	840	22	-73°C: 90	AW
Guaranty	≥750	830~970	≥14	-73°C ≥27	AW

Polarity

Example	AC
Guaranty	AC

Approvals

	NV
Single	V Y69M

Packages

Wire			Flux		
Dia. (mm)	Type	Weight (kg)	Mesh size	Type	Weight (kg)
3.2	coil	25	10x48	can	20
4.0	coil	25			
4.8	coil	25			

PF-H80AS/US-80LT

TRUSTARC™

SAW flux and wire combination for 780MPa high tensile strength steel

Classification: ASME / AWS A5.23 F11A10-EG-G

Features : •Suitable for butt and flat fillet welding of heavy duty structures

•DC-EP current is only applicable

•Excellent impact value at low temperatures down to -80°C

Redrying conditions of flux: 250~350°Cx1h

Chemical composition of wire (%) as per AWS

	C	Si	Mn	P	S	Ni	Mo	Cu
Example	0.12	0.15	2.03	0.007	0.002	2.75	0.77	0.10
Guaranty	≤0.15	≤0.25	1.75~ 2.25	≤0.015	≤0.015	2.40~ 2.90	0.60~ 0.90	≤0.40

Chemical composition of weld metal (%) as per AWS

	C	Si	Mn	P	S	Ni	Mo	Cu
Example	0.06	0.51	1.64	0.011	0.002	2.42	0.73	0.11
Guaranty	≤0.12	≤0.80	1.20~ 2.20	≤0.030	≤0.030	2.10~ 2.90	0.50~ 1.00	≤0.35

Mechanical properties of weld metal as per AWS

	0.2%OS (MPa)	TS (MPa)	EI (%)	IV (J)	PWHT
Example	740	860	23	-73°C: 83	AW
Guaranty	≥680	760~900	≥15	-73°C ≥27	AW

Polarity

Example	DC-EP
Guaranty	DC-EP

Approvals

	AB
Single	4YQ690

Packages

Wire			Flux		
Dia. (mm)	Type	Weight (kg)	Mesh size	Type	Weight (kg)
3.2	coil	25	10x48	can	20
4.0	coil	25			
4.8	coil	25			

PF-H55LT/US-36

TRUSTARC™

SAW flux and wire combination for mild steel and 490MPa high tensile strength steel for low temperature service

Classification: ASME / AWS A5.17 F7A8-EH14, F7P8-EH14

Features : •Suitable for butt welding of structures for low temperature service
•AC current is only applicable
•Excellent impact value at low temperatures down to -60°C and CTOD at temperatures down to -50°C

Redrying conditions of flux: 200~300°Cx1h

■ **Chemical composition of wire (%) as per AWS**

	C	Si	Mn	P	S	Cu
Example	0.12	0.03	1.95	0.013	0.008	0.08
Guaranty	0.10~0.18	≤0.05	1.70~2.20	≤0.030	≤0.030	≤0.30

■ **Chemical composition of weld metal (%) as per AWS**

	C	Si	Mn	P	S	Ti	B
Example	0.08	0.19	1.42	0.013	0.005	0.02	0.004

■ **Mechanical properties of weld metal as per AWS**

	0.2%OS MPa	TS Mpa	EI %	IV J	PWHT (°C×h)rs
Example	489	555	34	-62°C: 180	AW
	461	539	34	-62°C: 160	623x1
Guaranty	≥400	480~660	≥22	-62°C≥27	AW
	≥400	480~660	≥22	-62°C≥27	620±15x1

■ **Polarity**

Example	AC
Guaranty	AC

■ **Approvals**

	AB	LR	NV	BV	NK
Single	3M,3YM,MG	5Y40M(H5)	V YM,NV2-4,4-4	A4YM,MG	KAWL3M
Tandem	4YM,MG	-	V YM	-	-

■ **Packages**

Wire			Flux		
Dia. (mm)	Type	Weight (kg)	Mesh size	Type	Weight (kg)
3.2	coil	25,76,150	10x48	can	20
4.0	coil	25,75,150			
4.8	coil	25,75,150			

PF-H55AS/US-36J

TRUSTARC™

SAW flux and wire combination for mild steel and 490MPa high tensile strength steel for low temperature service

Classification: ASME / AWS A5.17 F7A8-EH14, F7P8-EH14

Features : •Suitable for butt welding of structures for low temperature service
•DC-EP current is only applicable
•Excellent impact value at low temperatures down to -60°C and CTOD at temperatures down to -20°C

Redrying conditions of flux: 200~300°Cx1h

■ **Chemical composition of wire (%) as per AWS**

	C	Si	Mn	P	S	Cu
Example	0.13	0.01	2.00	0.012	0.007	0.08
Guaranty	0.10~0.18	≤0.05	1.70~2.20	≤0.030	≤0.030	≤0.30

■ **Chemical composition of weld metal (%) as per AWS**

	C	Si	Mn	P	S	Ti	B
Example	0.07	0.23	1.42	0.009	0.004	0.02	0.004

■ **Mechanical properties of weld metal as per AWS**

	0.2%OS MPa	TS Mpa	EI %	IV J	PWHT (°C×h)
Example	485	555	33	-62°C: 170	AW
	432	532	31	-62°C: 180	620x1
Guaranty	≥400	480~660	≥22	-62°C≥27	AW
	≥400	480~660	≥22	-62°C≥27	620±15x1

■ **Polarity**

Example	DC-EP
Guaranty	DC-EP

■ **Approvals**

	AB	LR
Single	5Y400H5	5Y40MH5

■ **Packages**

Wire			Flux		
Dia. (mm)	Type	Weight (kg)	Mesh size	Type	Weight (kg)
3.2	coil	25	10x48	can	20
4.0	coil	25			
4.8	coil	25			

SAW Flux and Wire Combinations for Low Temperature Steel and 780MPa High

Tensile Strength Steel

Trade designation	ASME AWS Class.	Type of flux	Pol.	Features	Chemical composition (%)							Mechanical properties of weld metal						
					C	Si	Mn	P	S	Mo	Cr or Ni	0.2%OS (MPa)	TS (MPa)	EI (%)	IV (J)	PWHT (°Cxh)		
[F]MF-38/ [T]US-49A	A5.17 F7A6 -EH14 F7P6 -EH14	Fused	AC	<ul style="list-style-type: none"> •Suitable for multi-layer butt welding of structures for low temperature service •Excellent impact value at temperatures down to -40°C •RC: 150~350°Cx1h 	Wire-Ex	0.12	0.02	1.99	0.005	0.002	0.27	-	Ex	540	620	28	-51°C: 50	AW
					Wire-Gt	0.10~ 0.18	≤0.10	1.70~ 2.20	≤0.025	≤0.025	0.20~ 0.35	-		490	590	30	-51°C: 60	620x1
					Weld-Ex	0.09	0.40	1.63	0.019	0.013	0.21	-	Gt	≥400	480~ 660	≥22	-51°C ≥27	AW
														≥400	480~ 660	≥22	-51°C ≥27	620±15 x1
[T]PF-H80AK/ [T]US-80BN	A5.23 F11A4 -EG-G	Bonded	AC	<ul style="list-style-type: none"> •Suitable for butt and flat fillet welding of heavy structures •Bead appearance and slag removal are excellent •RC: 250~350°Cx1h 	Wire-Ex	0.10	0.13	2.59	0.013	0.002	0.88	Cr: 0.78	Ex	720	820	24	-40°C: 80	AW
					Wire-Gt	≤0.13	≤0.30	2.10~ 2.80	≤0.020	≤0.020	0.70~ 1.05	Cr: 0.70~ 0.90						
					Weld-Ex	0.07	0.30	2.01	0.007	0.004	0.85	Cr: 0.79	Gt	≥680	760~ 900	≥15	-40°C ≥27	AW
					Weld-Gt	≤0.12	≤0.80	1.50~ 2.50	≤0.020	≤0.020	0.60~ 1.20	Cr: 0.50~ 1.00						
[T]PF-H203/ [T]US-203E	A5.23 F7P15 -ENi3 -Ni3	Bonded	AC	<ul style="list-style-type: none"> •Suitable for multi-layer butt welding of 3.5% Ni steel •Excellent impact value at temperatures down to -100°C after PWHT •RC: 200~300°Cx1h 	Wire-Ex	0.06	0.18	0.98	0.007	0.005	-	Ni: 3.48	Ex	440	530	34	-101°C: 130	610x1
					Wire-Gt	≤0.13	0.05~ 0.30	0.60~ 1.20	≤0.020	≤0.020	-	Ni: 3.10~ 3.80						
					Weld-Ex	0.04	0.21	0.73	0.008	0.004	-	Ni: 3.35	Gt	≥400	480~ 660	≥22	-101°C ≥27	620±15 x1
					Weld-Gt	≤0.12	≤0.80	≤1.60	≤0.030	≤0.025	-	Ni: 2.80~ 3.80						

Note: Welding tests as per AWS, Wire-Ex: Example of wire, Wire-Gt: Guaranty of wire,
Ex: Example of weld metal (polarity: AC), Gt: Guaranty of weld metal (polarity: AC)

Weld-Ex: Example of weld metal, Weld-Gt: Guaranty of weld metal

■ Diameter of wire (mm)

US-49A 2.4, 3.2, 4.0, 4.8

US-80BN 3.2, 4.0, 4.8

US-203E 4.0

■ Mesh size of flux

MF-38 12x65, 20x200, 20xD

PF-H80AK 10x48

PF-H203 10x48

Welding Consumables and Proper Welding Conditions for

- **Shielded Metal Arc Welding (SMAW)**
- **Gas Metal Arc Welding (GMAW)**
- **Gas Tungsten Arc Welding (GTAW)**
- **Submerged Arc Welding (SAW)**

For Heat-Resistant Low-Alloy Steel

■ A guide for selecting welding consumables

Steel type	ASTM / ASME steel grade		SMAW
	Plate	Pipe / Tube	
Mn-Mo Mn-Mo-Ni	A302Gr.B,C,D A533Type A,B,C,D	-	BL-96 BL-106
0.5Mo	A204Gr.A,B,C	A209Gr.T1 A335Gr.P1	CM-A76
0.5Cr-0.5Mo	A387Gr.2 Cl.1, Cl.2	A213Gr.T2 A335Gr.P2	CM-B83 CM-B86
1Cr-0.5Mo 1.25Cr-0.5Mo	A387Gr.12 Cl.1, Cl.2 A387Gr.11 Cl.1, Cl.2	A213Gr.T11,T12 A335Gr.P11,T12	CM-A96 CM-A96MB (AC) CM-A96MBD (DCEP) CM-B95 CM-B98
2.25Cr-1Mo	A387Gr.22 Cl.1, Cl.2	A213Gr.T22 A335Gr.P22	CM-A106 CM-A106N (AC) CM-A106ND (DCEP) CM-B105 CM-B108
2.25Cr-1Mo-V	A542Type D Cl.4a A832Gr.22V	-	CM-A106H (AC) CM-A106HD (DCEP)
Low C 2.25Cr-W-V-Nb	-	SA213Gr.T23 SA335Gr.P23	CM-2CW
5Cr-0.5Mo	A387Gr.5 Cl.1, Cl.2	A213Gr.T5 A335Gr.P5	CM-5
9Cr-1Mo	A387Gr.9 Cl.1,Cl.2	A213Gr.T9 A335Gr.P9	CM-9
9Cr-1Mo-V-Nb	A387Gr.91 Cl.2	A213Gr.T91 A335Gr.P91	CM-9Cb CM-95B9 CM-96B9
9Cr-W-V-Nb 12Cr-W-V-Nb	-	A213Gr.T92 A335Gr.P92 SA213Gr.T122 SA335Gr.P122	CR-12S

GMAW	GTAW	SAW
MG-S56 MG-S63S	TG-S56 TG-S63S	MF-27/US-56B PF-200/US-56B PF-200/US-63S
MG-SM MG-M	TG-SM	MF-38/US-40 MF-38/US-49 MF-38/US-A4
MG-CM	TG-SCM	-
MG-S1CM MG-1CM	TG-S1CM TG-S1CML TG-S80B2	MF-29A/US-511 PF-200/US-511N (AC) PF-200D/US-511ND (DCEP)
MG-S2CM MG-S2CMS MG-2CM	TG-S2CM TG-S2CML TG-S90B3	MF-29A/US-521 PF-200/US-521S (AC) PF-200D/US-521S (DCEP)
-	TG-S2CMH	PF-500/US-521H (AC) PF-500D/US-521HD (DCEP)
MG-S2CW	TG-S2CW	PF-H80AK/US-2CW
MG-S5CM	TG-S5CM	PF-200S/US-502
MG-S9CM	TG-S9CM	-
MG-S9Cb	TG-S9Cb TG-S90B9	PF-200S/US-9Cb (AC) PF-90B9/US-90B9 (DCEP)
MG-S12CRS	TG-S12CRS	PF-200S/US-12CRS (AC) PF-200S/US-12CRSD (DCEP)

For Heat-Resistant Low-Alloy Steel

■ Tips for better welding results for individual welding processes

SMAW

- (1) Remove scale, rust, oil, grease, water, and other dirt from welding grooves beforehand to prevent defects such as porosity and cracking in the weld metal.
- (2) Use welding currents in the recommended range because the use of excessively high currents can cause imperfections such as poor X-ray soundness, much undercuts, much spatter, and hot cracking.
- (3) With low-hydrogen type electrodes, keep the arc length as short as possible to prevent porosity caused by nitrogen in the atmosphere. Limit the weaving width within two and a half times the diameter of the electrode. When striking an arc in the welding groove directly, use the backstep technique or strike an arc on a scrap plate before welding the groove to prevent blowholes in the arc starting bead.
- (4) Use preheating and interpass temperatures in the recommended range as shown in Table 1 in order to prevent the occurrence of cold cracks.
- (5) Use proper postweld heat treatment (PWHT) temperatures to ensure good mechanical properties of the weld. The use of an excessively high temperature can damage the weld causing inadequate tensile strength and impact value of the weld. In contrast, the use of an excessively low temperature can cause poor ductility and impact toughness of the weld in addition to inadequate stress relieving. The recommended ranges of PWHT temperatures are shown in Table 1. Hold weldments at PWHT temperatures for appropriate time according to the thickness of the base metal to ensure the quality of the weld.
- (6) Control heat input in predetermined ranges because heat input can markedly affect the crack resistibility and mechanical properties of the weld.

Table 1 Recommended temperatures for preheating and interpass control and PWHT

Type of steel	Preheating and interpass temperature (°C)	PWHT temperature (°C)
Mn-Mo-Ni steel	150-250	590-650
0.5Mo and 0.5Cr-0.5Mo steel	100-250	620-680
1Cr-0.5Mo and 1.25Cr-0.5Mo steel	150-300	650-700
2.25Cr-1Mo steel	200-350	680-730
5Cr-0.5Mo and 9Cr-1Mo steel	250-350	710-780

GMAW

- (1) Use DC-EP polarity.
- (2) Use an appropriate shielded gas flow rate as shown in Table 2 for recommendation.
- (3) In spray arc welding with a shielding gas of Ar/O₂ or Ar/5-20%CO₂ admixture, short circuiting noise may occur when the arc voltage is excessively low. In such a case, keep the arc length about 4-5 mm in order to prevent blowholes in the weld metal.
- (4) Refer to (1), (4), (5), (6) of the tips for SMAW.

Table 2 Recommended shielding gas flow rate

Flow rate (liter/min)	Nozzle standoff (mm)	Max wind velocity (m/sec)
20-25	20	2

GTAW

- (1) Use DC-EN polarity.
- (2) Use an appropriate shield gas flow rates as shown in Table 3.
- (3) Use back-shielding to ensure good reverse bead appearance and prevent the occurrence of porosity in the weld metal for low-alloy steels containing Cr over 1.25%.
- (4) Refer to (1), (4), (5), (6) of the tips for SMAW.

Table 3 Recommended shielding gas flow rate

Flow rate (liter/min)	Max. wind velocity (m/sec)
10-15	1

SAW

- (1) Control flux supply at an appropriate flux-burden height. The flux-burden height can affect the appearance of beads and X-ray soundness. The most appropriate height varies depending on flux mesh size, shape of welding groove and other welding conditions; however, single electrode welding commonly use 25-35 mm while tandem welding generally use 30-45 mm.
- (2) Use lower currents and slower speeds for root pass welding of thick plates to prevent cracking.
- (3) Refer to (1), (4), (5), (6) of the tips for SMAW.

For Heat-Resistant Low-Alloy Steel

■ **How to select the proper welding consumable for joining dissimilar metals**

The structural components of high temperature service equipment such as power generation boiler use several types of steels; therefore, joining dissimilar steels is unavoidable at the interface of different service condition areas. When joining carbon steels and Cr-Mo steels, or when joining dissimilar Cr-Mo steels, a filler metal with a composition similar to the lower-alloy steel or with an intermediate composition is commonly used for butt joints.

For instance, carbon steel can readily be joined to 2.25Cr-1Mo steel by using either a carbon steel or a 1.25Cr-0.5Mo steel filler metal; however, carbon steel filler metals are usually selected except where carbon migration (the diffusion of carbon from lower-Cr metal to higher-Cr metal during PWHT and high temperature service) must be decreased. Likewise, 2.25Cr-1Mo steel can be joined to 9Cr-1Mo-V-Nb steel by using a 2.25Cr-1Mo filler metal.

In contrast, Cr-Mo steel and austenitic stainless steel are joined with a high Cr-Ni stainless (e.g. E309) or, where carbon migration and thermal stress are important factors, nickel alloy (e.g. ENiCrFe-1) filler metal. For a quick guide to recommended welding consumables for joining dissimilar metals, refer to Table 1.

Note: (1) This table guides to recommended filler metals matching the lower-alloy steels in various dissimilar metal joints, excepting for Type 304 steel. Other types of filler metals may be needed where a specific requirement is imposed.

Note: (2) Preheating and postweld heat treatment for dissimilar Cr-Mo steels should be sufficient to the higher-alloy steel; however, the PWHT temperature should be lower to avoid damage to the lower-alloy steel and minimize the carbon migration. Type 304 stainless steel should not be preheated or postweld heat-treated to avoid sensitization.

Table 1 A quick guide to recommended welding consumables for joining dissimilar metals ^{(1) (2)}

Base metal	Mild steel	0.5Mo	1.25Cr-0.5Mo	2.25Cr-1Mo	5Cr-0.5Mo	9Cr-1Mo 9Cr-1Mo-V-Nb
Type 304 stainless steel	<ul style="list-style-type: none"> ●NC-39 (E309), NC-39L (E309L), TG-S309 (ER309), TG-S309L (ER309L) ●NI-C703D (ENiCrFe-3), NI-C70A (ENiCrFe-1), TG-S70NCb (ERNiCr-3) 					
9Cr-1Mo 9Cr-1Mo-V-Nb	LB-52 (E7016) TG-S50 (ER70S-G)	CM-A76 (E7016-A1) TG-SM (ER80S-G)	CM-A96 (E8016-B2) TG-S1CM (ER80S-G)	CM-A106 (E9016-B3) TG-S2CM (ER90S-G)	CM-5 (E8016-B6) TG-S5CM (ER80S-B6)	
5Cr-0.5Mo	LB-52 (E7016) TG-S50 (ER70S-G)	CM-A76 (E7016-A1) TG-SM (ER80S-G)	CM-A96 (E8016-B2) TG-S1CM (ER80S-G)	CM-A106 (E9016-B3) TG-S2CM (ER90S-G)		
2.25Cr-1Mo	LB-52 (E7016) TG-S50 (ER70S-G)	CM-A76 (E7016-A1) TG-SM (ER80S-G)	CM-A96 (E8016-B2) TG-S1CM (ER80S-G)			
1.25Cr-0.5Mo	LB-52 (E7016) TG-S50 (ER70S-G)	CM-A76 (E7016-A1) TG-SM (ER80S-G)				
0.5Mo	LB-52 (E7016) TG-S50 (ER70S-G)					

CM-A96



Low hydrogen type covered electrode for 1~1.25%Cr-0.5%Mo heat resistant steel

Classification: ASME / AWS A5.5 E8016-B2
JIS Z3223 DT2316

Features : •Suitable for butt and fillet welding
•Applied for ASTM A387 Gr.11, Gr.12 and equivalents

Redrying Conditions: 325~375°Cx1h

Welding Positions:

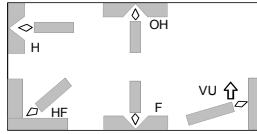

Chemical composition of all-weld metal (%) as per AWS

	C	Si	Mn	P	S	Cr	Mo
Example	0.06	0.38	0.72	0.008	0.004	1.31	0.54
Guaranty	0.05~0.12	≤0.60	≤0.90	≤0.03	≤0.03	1.00~1.50	0.40~0.65

Mechanical properties of all-weld metal as per AWS

	Temp. (°C)	0.2%OS (MPa)	TS (MPa)	EI (%)	IV (J)	PWHT (°Cxh)
Example	RT	570	650	26	0°C: 210	690x1
	450	460	520	21	-	690x1
Guaranty	RT	≥460	≥550	≥19	-	690±15x1

Recommended welding parameters

Dia.	2.6mm	3.2mm	4.0mm	5.0mm	6.0mm
F	55~85A	80~120A	125~175A	185~235A	240~300A
VU, OH	50~80A	75~110A	100~160A	-	-

Polarity

Example	AC
Guaranty	AC, DC-EP

Approvals

AB	LR	NV	BV	NK	Others
MG(E8016-B2)	MG(E8016-B2)	H10, NV1Cr0.5Mo	MG(E8016-B2)	MG(E8016-B2)	TÜV

Packages

Dia. (mm)	Length (mm)	Weight per pack (kg)	Weight per carton (kg)	Weight per piece (g)
2.6	300	2	20	17
3.2	350	5	20	29
4.0	400	5	20	53
5.0	400	5	20	82
6.0	400	5	20	122

CM-A96MB - CM-A96MBD



Low hydrogen type covered electrode for 1~1.25%Cr-0.5%Mo heat resistant steel

Classification: ASME / AWS A5.5 E8016-B2

JIS Z3223 DT2316 (CM-A96MB only)

Features : •Suitable for butt and fillet welding
•Applicable for ASTM A387 Gr.11, Gr.12 and equivalents
•AC is recommended for CM-A96MB and DC for CM-A96MBD
•Lower tensile strength and higher impact value

Redrying Conditions: 325~375°Cx1h

Welding Positions:

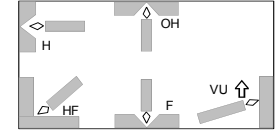

Chemical composition of all-weld metal (%) as per AWS

		C	Si	Mn	P	S	Cr	Mo
CM-A96MB	Example	0.06	0.45	0.74	0.007	0.003	1.30	0.54
	Guaranty	0.05~0.12	≤0.60	≤0.90	≤0.03	≤0.03	1.00~1.50	0.40~0.65
CM-A96MBD	Example	0.06	0.37	0.76	0.006	0.004	1.29	0.57
	Guaranty	0.05~0.12	≤0.60	≤0.90	≤0.03	≤0.03	1.00~1.50	0.40~0.65

Mechanical properties of all-weld metal as per AWS

		Temp. (°C)	0.2%OS (MPa)	TS (MPa)	EI (%)	IV (J)	PWHT (°Cxh)
CM-A96MB	Example	RT	490	590	30	-18°C: 200	690x1
		450	360	450	24	-18°C: 170*	690x1
	Guaranty	RT	≥460	≥550	≥19	-	690±15x1
CM-A96MBD	Example	RT	515	617	27	-20°C: 174	690x1
		450	394	484	19	-40°C: 78*	690x1
	Guaranty	RT	≥460	≥550	≥19	-	690±15x1

Recommended welding parameters

* 690x1+Step Cooling

Dia.	2.6mm (CM-A96MB only)	3.2mm	4.0mm	5.0mm	6.0mm
F	55~85A	80~120A	125~175A	185~235A	240~300A
VU, OH	50~80A	75~110A	100~160A	-	-

Polarity

CM-A96MB	Example	AC	CM-A96MBD	Example	DC-EP
	Guaranty	AC		Guaranty	DC-EP

Packages

Dia. (mm)	Length (mm)	Weight per pack (kg)	Weight per carton (kg)	Weight per piece (g)
2.6 (CM-A96MB only)	300	2	20	17
3.2	350	5	20	30
4.0	400	5	20	54
5.0	400	5	20	84
6.0	400	5	20	120

CM-A106



Low hydrogen type covered electrode for 2.25%Cr-1%Mo heat resistant steel

Classification: ASME / AWS A5.5 E9016-B3
JIS Z3223 DT2416

Features : •Suitable for butt and fillet welding
•Applied for ASTM A387 Gr.22 and equivalents

Redrying Conditions: 325~375°Cx1h

Welding Positions:

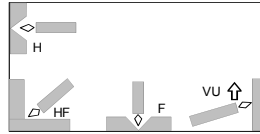

Chemical composition of all-weld metal (%) as per AWS

	C	Si	Mn	P	S	Cr	Mo
Example	0.07	0.34	0.61	0.006	0.004	2.10	0.96
Guaranty	0.05~0.12	≤0.60	≤0.90	≤0.03	≤0.03	2.00~2.50	0.90~1.20

Mechanical properties of all-weld metal as per AWS

	Temp. (°C)	0.2%OS (MPa)	TS (MPa)	EI (%)	IV (J)	PWHT (°C×h)
Example	RT	630	730	22	0°C: 120	690x1
	450	520	580	17	-	690x1
Guaranty	RT	≥530	≥620	≥17	-	690±15x1

Recommended welding parameters

	2.6mm	3.2mm	4.0mm	5.0mm	6.0mm
F	55~85A	90~130A	140~190A	190~240A	240~300A
VU, OH	50~80A	75~115A	100~160A	-	-

Polarity

Example	AC
Guaranty	AC, DC-EP

Approvals (CMA-106)

AB	LR	NV	BV	NK	Others
MG(E9016-B3)	MG(E9016-B3)	H10, NV2.25Cr1Mo	MG(E9016-B3)	MG(E9016-B3)	TÜV

Packages

Dia. (mm)	Length (mm)	Weight per pack (kg)	Weight per carton (kg)	Weight per piece (g)
2.6	300	2	20	17
3.2	350	5	20	30
4.0	400	5	20	55
5.0	400	5	20	85
6.0	400	5	20	121

CM-A106N - CM-A106ND



Low hydrogen type covered electrode for 2.25%Cr-1%Mo heat resistant steel

Classification: ASME / AWS A5.5 E9016-B3
JIS Z3223 DT2416 (CM-A106N only)

Features : •Suitable for butt and fillet welding
•Applicable for ASTM A387 Gr.22 and equivalents
•AC is recommended for CM-A106N and DC for CM-A106ND
•Lower tensile strength, higher impact value and less sensitive to temper embrittlement

Redrying Conditions: 325~375°Cx1h

Welding Positions:

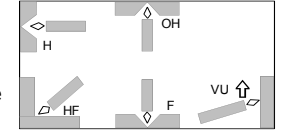

Chemical composition of all-weld metal (%) as per AWS

		C	Si	Mn	P	S	Cr	Mo
CM-A106N	Example	0.11	0.33	0.81	0.005	0.002	2.28	0.98
	Guaranty	0.05~0.12	≤0.60	≤0.90	≤0.03	≤0.03	2.00~2.50	0.90~1.20
CM-A106ND	Example	0.11	0.32	0.84	0.004	0.002	2.41	1.04
	Guaranty	0.05~0.12	≤0.60	≤0.90	≤0.03	≤0.03	2.00~2.50	0.90~1.20

Mechanical properties of all-weld metal as per AWS

		Temp. (°C)	0.2%OS (MPa)	TS (MPa)	EI (%)	IV (J)	PWHT (°C×h)
CM-A106N	Example	RT	510	650	28	-29°C: 120	690x8
		450	430	510	20	-29°C: 108*	690x8
	Guaranty	RT	≥530	≥620	≥17	-	690±15x1
CM-A106ND	Example	RT	501	635	26	-40°C: 151	690x8
		450	402	483	19	-60°C: 109*	690x8
	Guaranty	RT	≥530	≥620	≥17	-	690±15x1

Recommended welding parameters

	2.6mm (CMA-106N only)	3.2mm	4.0mm	5.0mm	6.0mm
F	55~85A	90~130A	140~190A	190~240A	240~300A
VU, OH	50~80A	75~115A	100~160A	-	-

Polarity

CMA-106N	Example	AC	CMA-106ND	Example	DC-EP
	Guaranty	AC		Guaranty	DC-EP

Packages

Dia. (mm)	Length (mm)	Weight per pack (kg)	Weight per carton (kg)	Weight per piece (g)
2.6 (CM-A106N only)	300	2	20	18
	350	5	20	31
	400	5	20	55
	400	5	20	86
	400	5	20	122

CM-A106H**TRUSTARC™**

Low hydrogen type covered electrode for 2.25%Cr-1%Mo-V heat resistant steel

- Features :**
- Suitable for butt and fillet welding
 - Applied for ASTM A336 Gr F22V and equivalents
 - Excellent tensile strength at high temperatures and good creep rupture strength

Redrying Conditions: 325~375°Cx1h

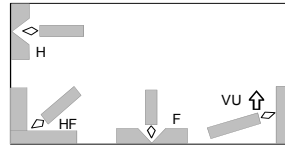
Welding Positions:**Chemical composition of all-weld metal (%) as per AWS**

	C	Si	Mn	P	S	Cr	Mo	V	Nb
Example	0.08	0.31	1.18	0.004	0.001	2.42	1.01	0.29	0.017
Guaranty	0.05~ 0.12	0.20~ 0.50	0.50~ 1.30	≤0.015	≤0.015	2.00~ 2.60	0.90~ 1.20	0.20~ 0.40	0.010~ 0.040

Mechanical properties of all-weld metal as per AWS

	0.2%OS (MPa)	TS (MPa)	EI (%)	IV (J)	PWHT (°C×h)
Example	612	713	23	-18°C: 147	705x7
Guaranty	≥420	≥590	≥18	-	705±15x8

Recommended welding parameters

Dia.	3.2mm	4.0mm	5.0mm
F	90~130A	140~190A	190~240A
VU	75~115A	100~160A	-

Polarity

Example	AC
Guaranty	AC

Packages

Dia. (mm)	Length (mm)	Weight per pack (kg)	Weight per carton (kg)	Weight per piece (g)
3.2	350	5	20	32
4.0	400	5	20	56
5.0	400	5	20	87

CM-A106HD**TRUSTARC™**

Low hydrogen type covered electrode for 2.25%Cr-1%Mo-V heat resistant steel

- Features :**
- Suitable for butt and fillet welding
 - Applicable for ASTM A336 Gr F22V and equivalents
 - Excellent tensile strength at high temperatures and good creep rupture strength by DC-EP current

Redrying Conditions: 325~375°Cx1h

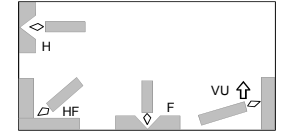
Welding Positions:**Chemical composition of all-weld metal (%) as per AWS**

	C	Si	Mn	P	S	Cr	Mo	V	Nb
Example	0.08	0.24	1.12	0.005	0.002	2.48	1.05	0.27	0.012
Guaranty	0.05- 0.15	0.20- 0.50	0.50- 1.30	≤0.015	≤0.015	2.00- 2.60	0.90- 1.20	0.20- 0.40	0.010- 0.040

Mechanical properties of all-weld metal as per AWS

	0.2%OS (MPa)	TS (MPa)	EI (%)	IV (J)	PWHT (°C×h)
Example	520	636	24	-30°C: 130	*1
Guaranty	≥420	≥590	≥18	-	705±15x8

*1: 705°Cx 8h for impact test, 705°Cx 26h for tensile test

Recommended welding parameters

Dia.	3.2mm	4.0mm	5.0mm
F	90~130A	140~190A	190~240A
VU	75~115A	100~160A	-

Polarity

Example	DC-EP
Guaranty	DC-EP

Packages

Dia. (mm)	Length (mm)	Weight per pack(kg)	Weight per carton(kg)	Weight per piece(g)
3.2	350	5	20	32
4.0	400	5	20	56
5.0	400	5	20	87

CM-9



Low hydrogen type covered electrode for 9%Cr-1%Mo heat resistant steel

Classification: ASME / AWS A5.5 E8016-B8
JIS Z3223 DT2616

Feature : •Suitable for butt and fillet welding
•Applied for ASTM A387 Gr.9 and equivalents

Redrying Conditions: 325~375°Cx1h

Welding Positions:

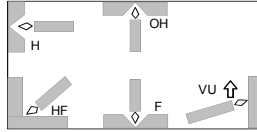

Chemical composition of all-weld metal (%) as per AWS

	C	Si	Mn	P	S	Cr	Mo
Example	0.08	0.40	0.68	0.007	0.004	9.56	1.03
Guaranty	0.05~ 0.10	≤0.90	≤1.0	≤0.03	≤0.03	8.0~ 10.5	0.85~ 1.20

Mechanical properties of all-weld metal as per AWS

	0.2%OS (MPa)	TS (MPa)	EI (%)	IV (J)	PWHT (°Cxh)
Example	510	680	26	0°C: 110	740x10
Guaranty	≥460	≥550	≥19	-	740±15x1

Recommended welding parameters

	2.6mm	3.2mm	4.0mm	5.0mm
F	55~85A	75~115A	120~160A	160~220A
VU, OH	50~80A	70~110A	90~150A	-

Polarity

Example	AC
Guaranty	AC, DC-EP

Packages

Dia. (mm)	Length (mm)	Weight per pack (kg)	Weight per carton (kg)	Weight per piece (g)
2.6	300	2	20	18
3.2	350	5	20	30
4.0	400	5	20	55
5.0	400	5	20	85

CM-9Cb



Low hydrogen type covered electrode for 9%Cr-1%Mo-Nb-V heat resistant steel

Classification: ASME / AWS A5.5 E9016-G

Features : •Suitable for butt and fillet welding
•Applicable for ASTM A387 Gr.91 and equivalents
•Excellent creep rupture strength
•Good performance by AC current

Redrying Conditions: 325~375°Cx1h

Welding Positions:

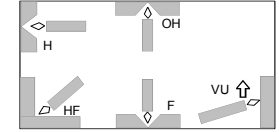

Chemical composition of all-weld metal (%) as per AWS

	C	Si	Mn	P	S	Ni	Cr	Mo	Nb	V
Example	0.06	0.31	1.51	0.006	0.003	0.94	9.11	1.06	0.03	0.18
Guaranty	≤0.12	≤0.60	≤2.00	≤0.025	≤0.025	≤1.00	8.00~ 10.50	0.80~ 1.20	≤0.15	≤0.50

Mechanical properties of all-weld metal as per AWS

	0.2%OS (MPa)	TS (MPa)	EI (%)	IV (J)	PWHT (°Cxh)
Example	600	750	25	0°C: 81	750x5
Guaranty	≥530	≥620	≥17	-	740±15x1

Recommended welding parameters

	2.6mm	3.2mm	4.0mm	5.0mm
Dia.	2.6mm	3.2mm	4.0mm	5.0mm
F	55~85A	75~115A	120~160A	160~220A
VU, OH	50~80A	70~110A	90~150A	-

Polarity

Example	AC
Guaranty	AC, DC-EP

Packages

Dia. (mm)	Length (mm)	Weight per pack (kg)	Weight per carton (kg)	Weight per piece (g)
2.6	300	2	20	18
3.2	350	5	20	31
4.0	400	5	20	55
5.0	400	5	20	85

CM-95B9 - CM-96B9



Low hydrogen type covered electrode for 9%Cr-1%Mo-Nb-V heat resistant steel

Classification: ASME / AWS A5.5 E9015-B9: CM-95B9
E9016-B9: CM-96B9

Features : •Suitable for butt and fillet welding
•Applied for ASTM A387 Gr.91 and equivalents
•Excellent creep rupture strength
•Good performance by DC-EP current

Redrying Conditions: 325~375°Cx1h

Welding Positions:

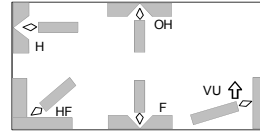

Chemical composition of all-weld metal (%) as per AWS

		C	Si	Mn	P	S	Ni	Cr	Mo	Nb	V
CM-95B9	Example	0.10	0.20	0.82	0.006	0.001	0.49	9.09	1.03	0.03	0.25
	Guaranty	0.08~0.13	≤0.30	≤1.20	≤0.01	≤0.01	≤0.80	8.0~10.5	0.85~1.20	0.02~0.10	0.15~0.30
CM-96B9	Example	0.10	0.23	0.83	0.005	0.001	0.48	9.08	1.06	0.03	0.24
	Guaranty	0.08~0.13	≤0.30	≤1.20	≤0.01	≤0.01	≤0.80	8.0~10.5	0.85~1.20	0.02~0.10	0.15~0.30
CM-95B9		Cu	Al	N	Mn+Ni						
	Example	0.03	0.006	0.05	1.31						
	Guaranty	≤0.25	≤0.04	0.02-0.07	≤1.50						
CM-96B9	Example	0.03	0.006	0.05	1.31						
	Guaranty	≤0.25	≤0.04	0.02-0.07	≤1.50						

Mechanical properties of all-weld metal as per AWS

		0.2%OS (MPa)	TS (MPa)	EI (%)	IV (J)	PWHT (°C×h)
CM-95B9	Example	651	768	22	20°C: 74	760x2
	Guaranty	≥530	≥620	≥17	-	760±15x2
CM-96B9	Example	657	771	21	20°C: 71	760x2
	Guaranty	≥530	≥620	≥17	-	760±15x2

Recommendable welding parameters

	Dia.	2.6mm	3.2mm	4.0mm	5.0mm
F	55~85A	75~115A	120~160A	160~220A	
VU, OH	50~80A	70~110A	90~150A	-	

Polarity

Example	DC-EP
Guaranty	DC-EP AC (CM-96B9 only)

Packages

Dia. (mm)	Length (mm)	Weight per pack (kg)	Weight per carton (kg)	Weight per piece (g)
2.6	300	2	20	18
3.2	350	5	20	31
4.0	400	5	20	55
5.0	400	5	20	85

CR-12S



Low hydrogen type covered electrode for T92/P92 and equivalent heat resistant steel

Features : •Suitable for butt and fillet welding
•Applicable for T92/P92 and equivalents
•Excellent creep rupture strength

Redrying Conditions: 325~375°Cx1h

Welding Positions:

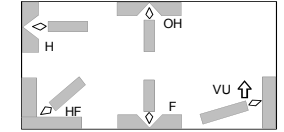

Chemical composition of all-weld metal (%) as per AWS

	C	Si	Mn	P	S	Cu	Ni
Example	0.08	0.41	0.94	0.008	0.001	0.02	0.52
Guaranty	≤0.15	≤0.60	0.50~1.50	≤0.025	≤0.025	≤0.25	≤1.50
	Co	Cr	Mo	V	Nb	W	N
Example	1.57	9.62	0.23	0.37	0.03	1.63	0.05
Guaranty	0.50~1.80	8.60~13.00	≤0.50	≤0.50	≤0.080	1.30~2.50	0.03~0.07

Mechanical properties of all-weld metal as per AWS

	0.2%OS (MPa)	TS (MPa)	EI (%)	IV (J)	PWHT (°C×h)
Example	645	771	22	0°C: 40	740x8
Guaranty	≥440	≥620	≥17	-	740±x8

Recommended welding parameters

	Dia.	2.6mm	3.2mm	4.0mm	5.0mm
F	55~85A	75~115A	120~160A	160~220A	
VU, OH	50~80A	70~110A	90~150A	-	

Polarity

Example	DC-EP
Guaranty	DC-EP, AC

Packages

Dia. (mm)	Length (mm)	Weight per pack (kg)	Weight per carton (kg)	Weight per piece (g)
2.6	300	2	20	18
3.2	350	5	20	31
4.0	400	5	20	55
5.0	400	5	20	85

Covered Electrodes for Heat-Resistant Low-Alloy Steel

Trade designation	ASME AWS Class.	Type of covering	Pol.	Features	WP	Chemical		composition of all-weld metal (%)					Mechanical properties of all-weld metal						
						C	Si	Mn	P	S	Cr	Mo	0.2%OS (MPa)	TS (MPa)	EI (%)	IV (J)	PWHT (°Cxh)		
CM-A76	A5.5 E7016 -A1	Low hydrogen	AC	•Suitable for 0.5%Mo steel •RC: 325~375°Cx1h	F	Ex	0.06	0.49	0.79	0.006	0.002	-	0.49	Ex	550	630	29	0°C: 210	620x1
			DC-EP		H	Gt	≤0.12	≤0.60	≤0.90	≤0.03	≤0.03	-	0.40~0.65	Gt	≥390	≥480	≥25	-	620±15x1
CM-B95	A5.5 E7015 -B2L	Low hydrogen	DC-EP	•Suitable for 1~1.25%Cr-0.5%Mo steel •DC-EP is only applicable. •RC: 325~375°Cx1h	F	Ex	0.03	0.87	0.71	0.005	0.004	1.20	0.49	Ex	470	580	29	0°C: 78	690x1
					H	Gt	≤0.05	≤1.00	≤0.90	≤0.03	≤0.03	1.00~1.50	0.40~0.65	Gt	≥390	≥520	≥19	-	690±15x1
CM-B98	A5.5 E8018 -B2	Low hydrogen	AC	•Iron powder low hydrogen type for 1~1.25%Cr-0.5%Mo steel •RC: 325~375°Cx1h	F	Ex	0.07	0.68	0.75	0.012	0.006	1.29	0.52	Ex	590	690	26	0°C: 66	690x1
			DC-EP		H	Gt	0.05~0.12	≤0.80	≤0.90	≤0.03	≤0.03	1.00~1.50	0.40~0.65	Gt	≥460	≥550	≥19	-	690±15x1
CM-B105	A5.5 E8015 -B3L	Low hydrogen	DC-EP	•Suitable for 2.25%Cr-1%Mo steel •DC-EP is only applicable •RC: 325~375°Cx1h	F	Ex	0.03	0.85	0.87	0.006	0.004	2.14	0.95	Ex	550	650	25	0°C: 79	690x1
					H	Gt	≤0.05	≤1.00	≤0.90	≤0.03	≤0.03	2.00~2.50	0.90~1.20	Gt	≥460	≥550	≥17	-	690±15x1
CM-B108	A5.5 E9018-B3	Low hydrogen	AC	•Iron powder low hydrogen type for 2.25%Cr-1%Mo steel •RC: 325~375°Cx1h	F	Ex	0.07	0.68	0.70	0.012	0.007	2.14	0.95	Ex	610	720	23	0°C: 106	690x1
			DC-EP		H	Gt	0.05~0.12	≤0.80	≤0.90	≤0.03	≤0.03	2.00~2.50	0.90~1.20	Gt	≥530	≥620	≥17	-	690±15x1

Note: Welding tests are as per AWS. Ex: Example (polarity: AC, except DC-EP for CMB-95/-105),

Gt: Guaranty (polarity: As specified above)

■ Approvals

CM-B98 LR

■ Diameter and Length (mm)

Dia.	2.6	3.2	4.0	5.0	6.0
CM-A76	300	350	400	400	400
CM-B95	300	350	400	400	-
CM-B98	300	400	450	450	450
CM-B105	300	350	400	400	-
CM-B108	300	400	450	450	-

Covered Electrodes for Heat-Resistant Low-Alloy Steel

Trade designation	ASME AWS Class.	Type of covering	Pol.	Features	WP	Chemical			composition of all-weld metal (%)					Mechanical properties of all-weld metal						
						C	Si	Mn	P	S	Cr	Mo	Others	0.2%OS (MPa)	TS (MPa)	EI (%)	IV (J)	PWHT (°C×h)		
CM-5	A5.5 E8016-B6	Low hydrogen	AC	▪Suitable for 5%Cr-0.5%Mo steel ▪RC: 325~375°Cx1h	F HF H	Ex	0.08	0.36	0.52	0.008	0.002	5.39	0.58	-	Ex	400	560	33	0°C: 150	750x8
			DC-EP		VU OH	Gt	0.05~0.10	≤0.90	≤1.0	≤0.03	≤0.03	4.0~6.0	0.45~0.65	-	Gt	≥460	≥550	≥19	-	740±15x1
CM-2CW	-	Low hydrogen	AC	▪Suitable for T23 tubes and P23 pipes ▪RC: 325~375°Cx1h	F HF H	Ex	0.05	0.28	0.73	0.007	0.005	2.25	0.09	W: 1.60 V: 0.22 Nb: 0.02	Ex	565	652	20	0°C: 105	715x2
			DC-EP		VU OH	Gt	≤0.15	≤0.60	0.10~1.60	≤0.020	≤0.010	1.90~2.60	0.05~0.85	W: 1.00~2.00 V: 0.15~0.30 Nb: 0.01~0.08	Gt	≥300	≥510	≥17	-	715±15x2

Note: Welding tests are as per AWS. Ex: Example (polarity: AC),

Gt: Guaranty (polarity: As specified above)

■ Diameter and Length (mm)

Dia.	2.6	3.2	4.0	5.0	6.0
CM-5	300	350	400	400	400
CM-2CW	300	350	400	-	-

Solid Wires for Heat-Resistant Low-Alloy Steel

Trade designation	ASME AWS Class.	SG	Pol.	Features	WP	Chemical composition of wire (%)					Mechanical properties of all-weld metal										
						C	Si	Mn	P	S	Ni	Cr	Mo	Cu	0.2%OS (MPa)	TS (MPa)	EI (%)	IV (J)	PWHT (°C x h) & SG		
MG-S56	A5.28 ER80S -G	Ar-5~20% CO ₂	DC-EP	•Suitable for Mn-Mo and Mn-Mo-Ni steel	F HF H VU OH	Ex	0.08	0.41	1.50	0.006	0.007	0.89	-	0.34	0.17	Ex	500	590	29	-40°C: 69	620x40 80%Ar-20%CO ₂
						Gt	≤0.10	0.30~0.90	1.00~1.60	≤0.020	≤0.020	0.50~1.00	-	0.20~0.60	≤0.35	Gt	≥470	≥550	≥19	-	620±15x1 80%Ar-20%CO ₂
MG-SM	A5.28 ER80S -G	Ar-2~5% O ₂	DC-EP	•Suitable for 0.5%Mo steel	F HF H VU OH	Ex	0.07	0.59	1.10	0.006	0.009	-	-	0.55	0.17	Ex	520	610	25	0°C: 98	AW 80%Ar-20%CO ₂
		Ar-5~20% CO ₂				Gt	≤0.15	0.30~0.90	0.60~1.60	≤0.025	≤0.025	-	-	0.40~0.65	≤0.40	Gt	≥470	≥550	≥19	-	620x1 80%Ar-20%CO ₂
MG-S1CM	A5.28 ER80S -G	Ar-2~5% O ₂	DC-EP	•Suitable for 1~1.25%Cr-0.5%Mo steel	F HF H VU OH	Ex	0.09	0.55	1.15	0.007	0.009	-	1.45	0.55	0.18	Ex	570	680	22	0°C: 69	620x1 80%Ar-20%CO ₂
		Ar-5~20% CO ₂				Gt	≤0.15	0.30~0.90	0.60~1.50	≤0.025	≤0.025	-	1.00~1.60	0.40~0.65	≤0.40	Gt	≥470	≥550	≥19	-	650x10 80%Ar-20%CO ₂
MG-S2CM	A5.28 ER90S -G	Ar-2~5% O ₂	DC-EP	•Suitable for 2.25%Cr-1%Mo steel	F HF H VU OH	Ex	0.08	0.56	1.07	0.005	0.009	-	2.35	1.11	0.17	Ex.	550	670	26	0°C: 110	680x1 80%Ar-20%CO ₂
		Ar-5~20% CO ₂				Gt	≤0.15	0.20~0.90	0.40~1.40	≤0.025	≤0.025	-	2.10~2.70	0.90~1.20	≤0.40	Gt	≥540	≥620	≥17	-	690x15 80%Ar-20%CO ₂

Note: Welding tests are as per AWS. Ex: Example, Gt: Guaranty

Approvals

MG-S1CM AB, LR, BV, TÜV

Diameter (mm)

MG-S56 1.2
 MG-SM 0.8, 0.9, 1.0, 1.2, 1.6
 MG-S1CM 0.8, 0.9, 1.0, 1.2, 1.4, 1.6
 MG-S2CM 0.8, 0.9, 1.0, 1.2, 1.4, 1.6

Solid Wires for Heat-Resistant Low-Alloy Steel

Trade designation	ASME AWS Class.	SG	Pol.	Features	WP	Chemical				composition of wire (%)							Mechanical properties of all-weld metal						
						C	Si	Mn	P	S	Ni	Cr	Mo	Cu	Nb	V	0.2%OS (MPa)	TS (MPa)	EI (%)	IV (J)	PWHT (°C/h) & SG		
MG-S5CM	A5.28 ER80S-B6	Ar-2~5% O ₂	DC-EP	*Suitable for 5%Cr-0.5%Mo steel	F	Ex	0.08	0.40	0.53	0.011	0.010	0.08	5.52	0.55	0.18	-	-	Ex	480	640	26	0°C: 78	700x2 98%Ar-2%O ₂
		Ar-5~20% CO ₂			H VU OH	Gt	≤0.10	≤0.50	0.40~0.70	≤0.025	≤0.025	≤0.6	4.50~6.00	0.45~0.65	≤0.35	-	-	Gt	≥470	≥550	≥17	-	745±15 x1 98%Ar-2%O ₂
MG-S9CM	S5.28 ER80S-B8	Ar-2~5% O ₂	DC-EP	*Suitable for 9%Cr-1%Mo steel	F	Ex	0.07	0.40	0.52	0.007	0.008	0.02	8.99	1.00	0.01	-	-	Ex	480	640	24	0°C: 130	720x2 98%Ar-2%O ₂
		Ar-5~20% CO ₂			H VU OH	Gt	≤0.10	≤0.50	0.40~0.70	≤0.025	≤0.025	≤0.5	8.00~10.5	0.8~1.2	≤0.35	-	-	Gt	≥470	≥550	≥17	-	745±15 x1 98%Ar-2%O ₂
MG-S9Cb	A5.28 ER90S-G	Ar-5% CO ₂	DC-EP	*Suitable for 9%Cr-1%Mo-Nb-V steel	F	Ex	0.08	0.35	1.59	0.007	0.008	0.45	8.79	0.88	0.01	0.02	0.17	Ex	570	700	27	0°C: 98	740x8 95%Ar-5%CO ₂
		H VU OH			Gt	≤0.12	≤0.70	≤2.20	≤0.020	≤0.020	≤1.00	8.00~10.00	0.80~1.20	≤0.35	≤0.10	≤0.50	Gt	≥410	≥620	≥16	-	745±15 x1 95%Ar-5%CO ₂	

Note: Welding tests are as per AWS. Ex: Example, Gt: Guaranty

Diameter (mm)

MG-S5CM	1.2, 1.6
MG-S9CM	1.2
MG-S9Cb	0.8, 1.0, 1.2, 1.6

TG-S1CM · TG-S1CML**TRUSTARC™**

TIG welding rod and wire for 1~1.25%Cr-0.5%Mo heat resistant steel

Classification: ASME / AWS A5.28 ER80S-G
 JIS Z3316 YGT1CM: TG-S1CM
 JIS Z3316 YGT1CML: TG-S1CML

Features : •Applied for ASTM A387 Gr.11, Gr.12 and equivalents
 •TG-S1CML: Lower carbon content

Shielding Gas: Ar**Polarity:** DC-EN**Chemical composition of rod and wire (%) as per AWS**

		C	Si	Mn	P	S	Cr	Mo	Ni	Cu
TG-S1CM	Example	0.08	0.52	1.10	0.007	0.009	1.40	0.55	0.02	0.11
	Guaranty	0.05~ 0.12	≤0.70	0.60~ 1.20	≤0.025	≤0.025	1.00~ 1.50	0.40~ 0.65	≤0.20	≤0.35
TG-S1CML	Example	0.03	0.50	1.13	0.005	0.009	1.40	0.49	0.04	0.12
	Guaranty	≤0.05	≤0.70	≤1.30	≤0.025	≤0.025	1.00~ 1.50	0.40~ 0.65	≤0.20	≤0.35

Mechanical properties of all-weld metal as per AWS

		0.2%OS (MPa)	TS (MPa)	EI (%)	IV (J)	PWHT (°Cx h)
TG-S1CM	Example	540	630	28	0°C: 270	690x1
	Guaranty	≥470	≥550	≥19	-	620±15x1
TG-S1CML	Example	480	580	31	0°C: 300	620x1
	Guaranty	≥470	≥550	≥19	-	AW

Approvals (only for TGS-1CM)

AB	LR	NV	BV	NK	Others
MG	MG(ER80S-G)	MG	MG(ER80S-G)	MG(E8016-B2)	KR, TÜV

Packages

Dia. (mm)	Type	Weight (kg)	Length (mm)	Weight per piece (g)	
				(TG-S1CM)	(TG-S1CML)
0.8	spool	10	-	○	-
1.0	spool	10	-	○	-
1.2	tube	5	1,000	9	-
	spool	10	-	○	○
	spool	20	-	○	-
1.6	tube	5	1,000	16	16
	spool	10	-	○	-
	spool	20	-	○	-
2.0	tube	5	1,000	25	25
2.4	tube	5	1,000	35	35
3.2	tube	5	1,000	63	63

TG-S80B2**TRUSTARC™**

TIG welding rod and wire for 1~1.25%Cr-0.5%Mo heat resistant steel

Classification: ASME / AWS A5.28 ER80S-B2
Features: •Applicable for ASTM A213 Gr.11 and equivalents
Shielding Gas: Ar
Polarity: DC-EN

Chemical composition of rod and wire (%) as per AWS

		C	Si	Mn	P	S	Cr	Mo	Ni	Cu
	Example	0.11	0.50	0.67	0.004	0.004	1.40	0.55	0.01	0.15
	Guaranty	0.07~ 0.12	0.40~ 0.70	0.40~ 0.70	≤0.025	≤0.025	1.20~ 1.50	0.40~ 0.65	≤0.25	≤0.35

Mechanical properties of all-weld metal as per AWS

		0.2%OS (MPa)	TS (MPa)	EI (%)	IV (J)	PWHT (°Cx h)
	Example	490	625	32	-20°C: 246	620x1
	Guaranty	≥470	≥550	≥19	-	620±15x1

Packages

Dia. (mm)	Type	Weight (kg)	Length (mm)	Weight per piece (g)
1.0	spool	10	-	-
1.2	spool	10	-	-
1.6	tube	5	1,000	16
2.0	tube	5	1,000	25
2.4	tube	5	1,000	35
3.2	tube	5	1,000	63

TG-S2CM · TG-S2CML**TRUSTARC™**

TIG welding rod and wire for 2.25%Cr-1%Mo heat resistant steel

Classification: ASME / AWS A5.28 ER90S-G: TG-S2CM
ER80S-G: TG-S2CML
JIS Z3316 YGT2CM: TG-S2CM
JIS Z3316 YGT2CML: TG-S2CML

Features : •Applied for ASTM A387 Gr.22 and equivalents
•TG-S2CML: Lower carbon content

Shielding Gas: Ar**Polarity:** DC-EN**Chemical composition of rod and wire (%) as per AWS**

		C	Si	Mn	P	S	Cr	Mo	Ni	Cu
TG-S2CM	Example	0.11	0.36	0.75	0.004	0.008	2.29	1.07	0.05	0.12
	Guaranty	0.05~ 0.13	≤0.70	0.50~ 1.20	≤0.025	≤0.025	2.00~ 2.50	0.90~ 1.20	≤0.20	≤0.35
TG-S2CML	Example	0.03	0.50	1.14	0.007	0.009	2.33	1.09	0.03	0.12
	Guaranty	≤0.05	≤0.70	≤1.30	≤0.025	≤0.025	2.10~ 2.60	0.90~ 1.20	≤0.20	≤0.35

Mechanical properties of all-weld metal as per AWS

		0.2%OS (MPa)	TS (MPa)	EI (%)	IV (J)	PWHT (°Cx h)
TG-S2CM	Example	610	720	28	0°C: 250	690x1
	Guaranty	≥540	≥620	≥17	-	690±15x1
TG-S2CML	Example	520	630	28	0°C: 250	690x1
	Guaranty	≥470	≥550	≥19	-	690±15x1

Approvals (only for TGS-2CM)

AB	NV	BV	NK	Others
MG	MG	MG(ER90S-G)	MG	KR, TÜV

Packages

Dia. (mm)	Type	Weight (kg)	Length (mm)	Weight per piece (g)	
				(TG-S2CM)	(TG-S2CML)
0.8	spool	10	-	○	-
1.0	spool	10	-	○	-
1.2	spool	10	-	○	-
	tube	5	1,000	9	-
1.6	spool	10	-	○	-
	tube	5	1,000	16	16
2.0	tube	5	1,000	25	25
2.4	tube	5	1,000	35	35
3.2	tube	5	1,000	63	-

TG-S90B3**TRUSTARC™**

TIG welding rod and wire for 2.25%Cr-1%Mo heat resistant steel

Classification: ASME / AWS A5.28 ER90S-B3
Features: •Applied for ASTM A387 Gr.22 and equivalents
Shielding Gas: Ar
Polarity: DC-EN

Chemical composition of rod and wire (%) as per AWS

	C	Si	Mn	P	S	Cr	Mo	Ni	Cu
Example	0.11	0.64	0.67	0.006	0.006	2.44	1.09	0.01	0.14
Guaranty	0.07~ 0.12	0.40~ 0.70	0.40~ 0.70	≤0.025	≤0.025	2.30~ 2.70	0.90~ 1.20	≤0.25	≤0.35

Mechanical properties of all-weld metal as per AWS

	0.2%OS (MPa)	TS (MPa)	EI (%)	IV (J)	PWHT (°Cx h)
Example	596	725	27	-20°C: 237	690x1
Guaranty	≥540	≥620	≥17	-	690±15x1

Packages

Dia. (mm)	Type	Weight (kg)	Length (mm)	Weight per piece (g)
1.0	spool	10	-	-
1.2	spool	10	-	-
1.6	tube	5	1,000	16
2.0	tube	5	1,000	25
2.4	tube	5	1,000	35
3.2	tube	5	1,000	63

TG-S2CMH**TRUSTARC™****TIG welding rod and wire for 2.25%Cr-1%Mo-V heat resistant steel**

Features : •Applicable for ASTM A336 Gr. F22V and equivalents
•Excellent tensile strength at high temperatures and good creep rupture strength

Shielding Gas: Ar

Polarity: DC-EN

Chemical composition of rod and wire (%) as per AWS

	C	Si	Mn	P	S	Cr
Example	0.12	0.16	0.43	0.005	0.008	2.31
Guaranty	0.10~0.13	≤0.70	0.20~0.70	≤0.025	≤0.025	2.00~2.50
	Mo	V	Nb	Ni	Cu	
Example	1.06	0.28	0.037	0.01	0.11	
Guaranty	0.90~1.20	0.20~0.40	0.015~0.040	≤0.20	≤0.35	

Mechanical properties of all-weld metal as per AWS

	0.2%OS (MPa)	TS (MPa)	EI (%)	IV (J)	PWHT (°Cx h)
Example	623	730	22	-18°C: 300	705x7
Guaranty	≥420	≥590	≥18	-	705±15x8

Packages

Dia. (mm)	Type	Weight (kg)	Length (mm)	Weight per piece (g)
1.2	tube	5	1,000	9
1.6	tube	5	1,000	16
2.0	tube	5	1,000	25
2.4	tube	5	1,000	35

TG-S9CM**TRUSTARC™****TIG welding rod and wire for 9%Cr-1%Mo heat resistant steel**

Classification: ASME / AWS A5.28 ER80S-B8

Features: •Applied for ASTM A387 Gr.9 and equivalents

Shielding Gas: Ar

Polarity: DC-EN

Chemical composition of rod and wire (%) as per AWS

	C	Si	Mn	P	S	Cr
Example	0.07	0.39	0.52	0.006	0.009	8.98
Guaranty	≤0.10	≤0.50	0.40~0.70	≤0.025	≤0.025	8.00~10.5
	Mo	Ni	Cu			
Example	1.00	0.18	0.01			
Guaranty	0.8~1.2	≤0.50	≤0.35			

Mechanical properties of all-weld metal as per AWS

	0.2%OS (MPa)	TS (MPa)	EI (%)	IV (J)	PWHT (°Cx h)
Example	410	590	32	0°C: 220	750x2
Guaranty	≥470	≥550	≥17	-	745±15x1

Packages

Dia. (mm)	Type	Weight (kg)	Length (mm)	Weight per piece (g)
1.2	spool	20	-	-
1.6	tube	5	1,000	16
2.0	tube	5	1,000	25
2.4	tube	5	1,000	35
3.2	tube	5	1,000	63

TG-S9Cb**TRUSTARC™****TIG welding rod and wire for 9%Cr-1%Mo-Nb-V heat resistant steel****Classification:** ASME / AWS A5.28 ER90S-G**Features :** •Applied for ASTM A387 Gr.91 and equivalents
•Excellent creep rupture strength**Shielding Gas:** Ar**Polarity:** DC-EN**Chemical composition of rod and wire (%) as per AWS**

	C	Si	Mn	P	S	Cr
Example	0.08	0.16	1.01	0.006	0.005	9.01
Guaranty	≤0.12	≤0.60	≤1.20	≤0.020	≤0.010	8.00~10.00
	Mo	Ni	Nb	V	Cu	
Example	0.90	0.71	0.04	0.18	0.01	
Guaranty	0.85~1.20	≤0.80	0.02~0.12	0.10~0.35	≤0.35	

Mechanical properties of all-weld metal as per AWS

	0.2%OS (MPa)	TS (MPa)	EI (%)	IV (J)	PWHT (°Cx h)
Example	700	780	24	0°C: 240	740x8
Guaranty	≥410	≥620	≥16	-	745±15x1

Packages

Dia. (mm)	Type	Weight (kg)	Length (mm)	Weight per piece (g)
0.8	spool	10	-	-
1.0	spool	10	-	-
1.2	spool	10	-	-
1.6	spool	10	-	-
	tube	5	1,000	16
2.0	tube	5	1,000	25
2.4	tube	5	1,000	35
3.2	tube	5	1,000	63

TG-S90B9**TRUSTARC™****TIG welding rod and wire for 9%Cr-1%Mo-Nb-V heat resistant steel****Classification:** ASME / AWS A5.28 ER90S-B9**Features :** •Applied for ASTM A387 Gr.91 and equivalents
•Excellent creep rupture strength**Shielding Gas:** Ar**Polarity:** DC-EN**Chemical composition of rod and wire (%) as per AWS**

	C	Si	Mn	P	S	Cu	Cr
Example	0.12	0.25	0.75	0.006	0.004	0.01	9.20
Guaranty	0.07~0.13	0.15~0.50	≤1.20	≤0.010	≤0.010	≤0.20	8.00~10.50
	Mo	Ni	V	Al	Nb	N	Mn+Ni
Example	1.00	0.49	0.21	-	0.05	0.04	1.24
Guaranty	0.85~1.20	≤0.80	0.15~0.30	≤0.04	0.02~0.10	0.03~0.07	≤1.50

Mechanical properties of all-weld metal as per AWS

	0.2%OS (MPa)	TS (MPa)	EI (%)	IV (J)	PWHT (°Cx h)
Example	706	809	22	0°C: 160	760x2
Guaranty	≥410	≥620	≥16	-	760±15x2

Packages

Dia. (mm)	Type	Weight (kg)	Length (mm)	Weight per piece(g)
1.0	spool	10	-	-
1.2	spool	10	-	-
	spool	20	-	-
1.6	spool	10	-	-
	spool	20	-	-
1.6	tube	5	1,000	16
2.0	tube	5	1,000	25
2.4	tube	5	1,000	35

Trade designation	ASME AWS Class.	SG	Pol.	Features	Chemical composition of rod and wire (%)										Mechanical properties of all-weld metal						
					C	Si	Mn	P	S	Ni	Cr	Mo	Cu	Others	0.2%OS (MPa)	TS (MPa)	EL (%)	IV (J)	PWHT (°C/h)		
TG-S56	A5.28 ER80S-G	Ar	DC-EN	•Suitable for Mn-Mo and Mn-Mo-Ni steel	Ex	0.10	0.41	1.59	0.007	0.007	0.66	-	0.50	0.11	-	Ex	520	590	31	-12°C: 290	620x1
					Gt	≤0.12	0.20~0.60	1.20~1.80	≤0.025	≤0.025	0.40~0.80	-	0.40~0.60	≤0.35	-	Gt	≥470	≥550	≥19	-	620±15x1
TG-S63S	A5.28 ER90S-G	Ar	DC-EN	•Suitable for Mn-Mo and Mn-Mo-Ni steel	Ex	0.10	0.39	1.23	0.008	0.005	1.58	-	0.39	0.10	-	Ex	566	655	27	-12°C: 256	625x15
					Gt	≤0.15	0.20~0.50	1.05~1.45	≤0.025	≤0.025	1.45~1.75	-	0.25~0.55	≤0.35	-	Gt	≥480	≥620	≥16	-	620x1
TG-SM	A5.28 ER80S-G	Ar	DC-EN	•Suitable for 0.5%Mo steel	Ex	0.08	0.54	1.04	0.004	0.007	0.02	-	0.53	0.12	-	Ex	500	580	32	0°C: 280	620x1
					Gt	0.05~0.12	≤0.80	≤1.50	≤0.025	≤0.025	≤0.20	-	0.40~0.65	≤0.35	-	Gt	≥470	≥550	≥19	-	AW
TG-S5CM	A5.28 ER80S-B6	Ar	DC-EN	•Suitable for 5%Cr-0.5%Mo steel	Ex	0.09	0.41	0.49	0.006	0.009	0.04	5.44	0.55	0.12	-	Ex	480	600	26	0°C: 280	750x2
					Gt	≤0.10	≤0.50	0.40~0.70	≤0.025	≤0.025	≤0.60	4.50~6.00	0.45~0.65	≤0.35	-	Gt	≥470	≥550	≥17	-	745±15x1
TG-S2CW	-	Ar	DC-EN	•Suitable for SA213Gr. T23 tubes and SA335Gr. P23 pipes	Ex	0.04	0.41	0.45	0.005	0.004	-	2.32	0.52	0.10	V: 0.33 Nb: 0.031 W: 1.22 Al: -	Ex	467	578	31	0°C: 205	715x2
					Gt	≤0.15	≤0.60	0.10~1.60	≤0.020	≤0.010	-	1.90~2.60	0.05~0.85	≤0.40	V: 0.15~0.40 Nb: 0.01~0.08 W: 1.00~2.00 Al≤0.03	Gt	≥300	≥510	≥20	-	715±15x2
TG-S12CRS	-	Ar	DC-EN	•Suitable for T92/P92 and equivalents •Excellent creep rupture strength	Ex	0.07	0.36	0.74	0.004	0.003	0.51	9.92	0.35	0.01	V: 0.21 Nb: 0.04 W: 1.45 Co: 1.01 N: 0.04	Ex	686	790	23	0°C: 44	740x8
					Gt	≤0.15	≤0.50	≤1.00	≤0.020	≤0.010	≤0.80	9.50~12.00	0.10~0.70	≤0.25	V: 0.05~0.35 Nb: 0.01~0.10 W: 1.00~2.00 Co: 0.80~1.20 N: 0.03~0.07	Gt	≥440	≥620	≥17	-	740x8

Note: Welding tests are as per AWS. Ex: Example, Gt: Guaranty

■ Approvals

TG-S56 TÜV

■ Diameter (mm)

TG-S56	1.2, 1.6, 2.0, 2.4, 3.2	TG-S5CM	1.2, 2.0, 2.4, 3.2
TG-S63S	1.2, 1.6, 2.0, 2.4, 3.2	TG-S2CW	0.8, 1.0, 1.2, 1.6, 2.0, 2.4
TG-SM	0.8, 1.0, 1.2, 1.6, 2.0, 2.4, 3.2	TG-S12CRS	0.8, 1.0, 1.2, 1.6, 2.0, 2.4

FAMILIARC™ MF-38 / TRUSTARC™ US-49**SAW flux and wire combination for 0.5%Mo heat resistant steel**

Classification : ASME / AWS A5.23 F8P6-EG-A4
F8A4-EG-A4

JIS Z3183 S584-H

Features : • Suitable for single or multi-pass butt welding of 0.5%Mo steel
• Good mechanical properties of multi-layer weld metal in the as-welded and PWHT conditions

Redrying conditions of flux: 150~350°Cx1h

Chemical composition of wire (%) as per AWS

	C	Si	Mn	P	S	Mo	Cu
Example	0.09	0.03	1.58	0.014	0.013	0.52	0.10
Guaranty	0.07~ 0.12	≤0.05	1.25~ 1.80	≤0.025	≤0.025	0.45~ 0.60	≤0.35

Chemical composition of weld metal (%) as per AWS

	C	Si	Mn	P	S	Mo	Cu
Example	0.10	0.37	1.35	0.014	0.014	0.53	-
Guaranty	≤0.15	≤0.80	≤1.60	≤0.030	≤0.030	0.40~0.65	≤0.35

Mechanical properties of weld metal (AC) as per AWS

	0.2%OS (MPa)	TS (MPa)	EI (%)	IV (J)	PWHT (°C×h)
Example	510	600	29	-51°C: 40	600x3
Guaranty	≥470	550~690	≥20	-51°C≥27	620±15x1

Polarity

Example	AC
Guaranty	AC

Approvals (Single)

AB	LR	NV	BV	NK	Others
3YTM	3T,3YM,3YT	ⅢYTM	A3YTM	KAW3Y46TMH10	CCS

Packages

Wire		
Dia. (mm)	Type	Weight (kg)
1.6	spool	10,20
2.0	spool	10,20
2.4	coil	25
	spool	10,20
3.2	coil	25,76
4.0	coil	25,75
4.8	coil	25,75
6.4	coil	25

Flux

Mesh size	Type	Weight (kg)
12x65	can	25
20x200	can	25
20xD	can	25

FAMILIARC™ MF-38 / TRUSTARC™ US-A4**SAW flux and wire combination for 0.5%Mo heat resistant steel**

Classification : ASME / AWS A5.23 F8P6-EA4-A4
F8A4-EA4-A4

JIS Z3183 S584-H

Features : •Suitable for single or multi-pass butt welding of 0.5%Mo steel
•Good mechanical properties in multi-layer welding in the as-welded and PWHT conditions

Redrying conditions of flux: 150~350°Cx1h

Chemical composition of wire (%) as per AWS

	C	Si	Mn	P	S	Mo	Cu
Example	0.09	0.04	1.59	0.010	0.014	0.52	0.10
Guaranty	0.05~ 0.15	≤0.20	1.20~ 1.70	≤0.025	≤0.025	0.45~ 0.65	≤0.35

Chemical composition of weld metal (%) as per AWS

	C	Si	Mn	P	S	Mo	Cu
Example	0.10	0.39	1.35	0.013	0.013	0.52	0.11
Guaranty	≤0.15	≤0.80	≤1.60	≤0.030	≤0.030	0.40~0.65	≤0.35

Mechanical properties of weld metal as per AWS

	0.2%OS (MPa)	TS (MPa)	EI (%)	IV (J)	PWHT (°C×h)
Example	510	600	29	-51°C: 40	620x1
Guaranty	≥470	550~690	≥20	-51°C≥27	620±15x1

Polarity

Example	AC
Guaranty	AC

Packages

Wire			Flux		
Dia. (mm)	Type	Weight (kg)	Mesh size	Type	Weight (kg)
3.2	coil	25	12x65	can	25
4.0	coil	25	20x200	can	25
4.8	coil	25	20xD	can	25

FAMILIARC™ MF-38 / TRUSTARC™ US-40**SAW flux and wire combination for 0.5%Mo heat resistant steel**

Classification : ASME / AWS A5.23 F8P6-EA3-A3
F9A6-EA3-A3

JIS Z3183 S624-H1

Features : •Suitable for single or multi-pass butt welding of 0.5%Mo steel
•Good mechanical properties in multi-layer welding in the as-welded and PWHT conditions

Redrying conditions of flux: 150~350°Cx1h

Chemical composition of wire (%) as per AWS

	C	Si	Mn	P	S	Mo	Cu
Example	0.13	0.04	1.80	0.008	0.010	0.52	0.12
Guaranty	0.05~0.17	≤0.20	1.65~2.20	≤0.025	≤0.025	0.45~0.65	≤0.35

Chemical composition of weld metal (%) as per AWS

	C	Si	Mn	P	S	Mo	Cu
Example	0.08	0.34	1.58	0.017	0.009	0.45	0.12
Guaranty	≤0.15	≤0.80	≤2.10	≤0.030	≤0.030	0.40~0.65	≤0.35

Mechanical properties of weld metal as per AWS

	0.2%OS (MPa)	TS (MPa)	EI (%)	IV (J)	PWHT (°C×h)
Example	560	630	29	-51°C: 58	620X1
Guaranty	≥470	550~690	≥20	-51°C≥27	620±15x1

Polarity

Example	AC
Guaranty	AC

Approvals

	AB	NK
Single	MG	KAW3Y50MH10

Packages

Wire			Flux		
Dia. (mm)	Type	Weight (kg)	Mesh size	Type	Weight (kg)
2.0	spool	20	12x65	can	25
2.4	coil	25	20x200	can	25
3.2	coil	25,75,150	20xD	can	25
4.0	coil	25,75			
4.8	coil	25,75,150			
6.4	coil	25			

PF-200/US-511N

TRUSTARC™

SAW flux and wire combination for 1~1.25%Cr-0.5%Mo heat resistant steel

Classification: ASME / AWS A5.23 F8P2-EG-B2
JIS Z3183 S642-1CM

Features : •Suitable for multi-pass butt welding of 1~1.25%Cr-0.5%Mo steel
•AC current is recommended
• Excellent notch toughness

Redrying conditions of flux: 200~300°Cx1h

■ Chemical composition of wire (%) as per AWS

	C	Si	Mn	P	S	Cr	Mo	Cu
Example	0.13	0.11	0.70	0.005	0.002	1.50	0.53	0.14
Guaranty	≤0.15	≤0.30	0.50~ 1.00	≤0.015	≤0.015	1.25~ 1.80	0.40~ 0.65	≤0.25

■ Chemical composition of weld metal (%) as per AWS

	C	Si	Mn	P	S	Cr	Mo	Cu
Example	0.10	0.10	0.74	0.007	0.002	1.43	0.54	0.14
Guaranty	0.05~ 0.15	≤0.80	≤1.20	≤0.030	≤0.030	1.00~ 1.50	0.40~ 0.65	≤0.35

■ Mechanical properties of weld metal as per AWS

	0.2%OS (MPa)	TS (MPa)	EI (%)	IV (J)	PWHT (°C×h)
Example	450	560	31	-29°C: 120	690x8
Guaranty	≥470	550~690	≥20	-29°C≥27	690±15x1

■ Polarity

Example	AC
Guaranty	AC

■ Packages

Wire			Flux		
Dia. (mm)	Type	Weight (kg)	Mesh size	Type	Weight (kg)
3.2	coil	25	10x48	can	20
4.0	coil	25			
4.8	coil	25			

PF-200D/US-511ND

TRUSTARC™

SAW flux and wire combination for 1~1.25%Cr-0.5%Mo heat resistant steel

Classification: ASME / AWS A5.23 F8P2-EG-B2

Features : •Suitable for multi-pass butt welding of 1~1.25%Cr-0.5%Mo steel
•DC current is recommended

Redrying conditions of flux: 200~300°Cx1h

■ Chemical composition of wire (%) as per AWS

	C	Si	Mn	P	S	Cr	Mo	Cu
Example	0.13	0.09	0.92	0.005	0.003	1.49	0.56	0.10
Guaranty	≤0.15	≤0.30	0.50~ 1.00	≤0.015	≤0.015	1.25~ 1.80	0.40~ 0.65	≤0.25

■ Chemical composition of weld metal (%) as per AWS

	C	Si	Mn	P	S	Cr	Mo	Cu
Example	0.08	0.21	0.82	0.007	0.003	1.39	0.56	0.09
Guaranty	0.05~ 0.15	≤0.80	≤1.20	≤0.030	≤0.030	1.00~ 1.50	0.40~ 0.65	≤0.35

■ Mechanical properties of weld metal as per AWS

	0.2%OS (MPa)	TS (MPa)	EI (%)	IV (J)	PWHT (°C×h)
Example	477	589	27	-29°C: 116	690x4
Guaranty	≥470	550~690	≥20	-29°C≥27	690±15x1

■ Polarity

Example	DC-EP
Guaranty	DC-EP

■ Packages

Wire			Flux		
Dia. (mm)	Type	Weight (kg)	Mesh size	Type	Weight (kg)
3.2	coil	25	10x48	can	20
4.0	coil	25			

PF-200/US-521S

TRUSTARC™

SAW flux and wire combination for 2.25%Cr-1%Mo heat resistant steel

Classification: ASME / AWS A5.23 F9P2-EG-B3
JIS Z3183 S642-2CM

Features : •Suitable for multi-pass butt welding of 2.25%Cr-1%Mo steel
•AC current is recommended
•Excellent notch toughness

Redrying conditions of flux: 200~300°Cx1h

Chemical composition of wire (%) as per AWS

	C	Si	Mn	P	S	Cr	Mo	Cu
Example	0.16	0.14	1.00	0.005	0.002	2.45	1.05	0.12
Guaranty	0.08~ 0.18	≤0.25	0.80~ 1.20	≤0.012	≤0.012	2.20~ 2.70	0.90~ 1.20	≤0.30

Chemical composition of weld metal (%) as per AWS

	C	Si	Mn	P	S	Cr	Mo	Cu
Example	0.12	0.10	0.82	0.008	0.001	2.34	1.04	0.12
Guaranty	0.05~ 0.15	≤0.80	≤1.20	≤0.030	≤0.030	2.00~ 2.50	0.90~ 1.20	≤0.35

Mechanical properties of weld metal as per AWS

	0.2%OS (MPa)	TS (MPa)	EI (%)	IV (J)	PWHT (°C×h)
Example	470	610	27	-29°C: 150	690x8
Guaranty	≥540	620~760	≥17	-29°C≥27	690±15x1

Polarity

Example	AC
Guaranty	AC

Packages

Wire			Flux		
Dia. (mm)	Type	Weight (kg)	Mesh size	Type	Weight (kg)
3.2	coil	25	10x48	can	20
4.0	coil	25			
4.8	coil	25			

PF-200D/US-521S

TRUSTARC™

SAW flux and wire combination for 2.25%Cr-1%Mo heat resistant steel

Classification: ASME / AWS A5.23 F9P2-EG-B3

Features : •Suitable for multi-pass butt welding of 2.25%Cr-1%Mo steel
•DC current is recommended

Redrying conditions of flux: 200~300°Cx1h

Chemical composition of wire (%) as per AWS

	C	Si	Mn	P	S	Cr	Mo	Cu
Example	0.17	0.14	0.96	0.004	0.002	2.44	1.07	0.13
Guaranty	0.08~ 0.18	≤0.25	0.80~ 1.20	≤0.012	≤0.012	2.20~ 2.70	0.90~ 1.20	≤0.30

Chemical composition of weld metal (%) as per AWS

	C	Si	Mn	P	S	Cr	Mo	Cu
Example	0.09	0.16	0.81	0.006	0.003	2.41	1.07	0.13
Guaranty	0.05~ 0.15	≤0.80	≤1.20	≤0.030	≤0.030	2.00~ 2.50	0.90~ 1.20	≤0.35

Mechanical properties of weld metal as per AWS

	0.2%OS (MPa)	TS (MPa)	EI (%)	IV (J)	PWHT (°C×h)
Example	507	621	26	-29°C: 164	690x6
Guaranty	≥540	620~760	≥17	-29°C≥27	690±15x1

Polarity

Example	DC-EP
Guaranty	DC-EP

Packages

Wire			Flux		
Dia. (mm)	Type	Weight (kg)	Mesh size	Type	Weight (kg)
3.2	coil	25	10x48	can	20
4.0	coil	25			
4.8	coil	25			

PF-500/US-521H**TRUSTARC™****SAW flux and wire combination for 2.25%Cr-1%Mo-V heat resistant steel**

- Features :**
- Suitable for multi-pass butt welding of ASTM A336 Gr. F22V and equivalents
 - AC current is recommended
 - Excellent tensile strength at high temperatures and good creep rupture strength

Redrying conditions of flux: 200~300°Cx1h

Chemical composition of wire (%) as per AWS

	C	Si	Mn	P	S
Example	0.13	0.20	1.27	0.004	0.002
Guaranty	≤0.18	≤0.25	0.30~1.40	≤0.025	≤0.025
	Cr	Mo	V	Nb	Cu
Example	2.55	0.98	0.39	0.02	0.12
Guaranty	2.00~2.65	0.90~1.20	0.25~0.45	0.010~0.040	≤0.30

Chemical composition of weld metal (%) as per AWS

	C	Si	Mn	P	S
Example	0.08	0.13	1.16	0.006	0.001
Guaranty	0.05~0.15	0.05~0.35	0.50~1.30	≤0.015	≤0.015
	Cr	Mo	V	Nb	Cu
Example	2.53	1.03	0.35	0.015	0.10
Guaranty	2.00~2.60	0.90~1.20	0.20~0.40	0.010~0.040	-

Mechanical properties of weld metal as per AWS

	0.2%OS (MPa)	TS (MPa)	EI (%)	IV (J)	PWHT (°C×h)
Example	620	710	26	-18°C:150	705x7
Guaranty	≥420	590~760	≥16	-	705±15x8

Polarity

Example	AC
Guaranty	AC

Packages

Wire			Flux		
Dia. (mm)	Type	Weight (kg)	Mesh size	Type	Weight (kg)
4.0	coil	25	10x48	can	20

PF-500D / US-521HD**TRUSTARC™****SAW flux and wire combination for 2.25%Cr-1%Mo-V heat resistant steel**

- Features :**
- Suitable for multi-pass butt welding
 - Applicable for ASTM A336 Gr F22V and equivalents
 - Excellent tensile strength at high temperatures and good creep rupture strength by DC-EP current

Redrying conditions of flux: 200~300°Cx1h

Chemical composition of wire (%) as per AWS

	C	Si	Mn	P	S
Example	0.16	0.21	1.30	0.003	0.001
Guaranty	≤0.18	≤0.25	0.30-1.40	≤0.025	≤0.025
	Cr	Mo	V	Nb	Cu
Example	2.54	1.03	0.38	0.022	0.11
Guaranty	2.00-2.65	0.90-1.20	0.25-0.45	0.010-0.040	≤0.30

Chemical composition of weld metal (%) as per AWS

	C	Si	Mn	P	S
Example	0.07	0.17	1.26	0.007	0.001
Guaranty	0.05-0.15	0.05-0.35	0.50-1.30	≤0.015	≤0.015
	Cr	Mo	V	Nb	Cu
Example	2.44	1.03	0.34	0.011	0.10
Guaranty	2.00-2.60	0.90-1.20	0.20-0.40	0.010-0.040	-

Mechanical properties of weld metal as per AWS

	0.2%OS (MPa)	TS (MPa)	EI (%)	IV (J)	PWHT (°C×h)
Example	518	634	26	-30°C:106	*1
Guaranty	≥420	≥590	≥18	-	705±15x8

*1: 705°Cx 8h for impact test, 705°Cx 26h for tensile test

Polarity

Example	DC-EP
Guaranty	DC-EP

Packages

Wire			Flux		
Dia. (mm)	Type	Weight (kg)	Mesh size	Type	Weight (kg)
4.0	coil	25	10x48	can	20

PF-200S/US-9Cb**TRUSTARC™****SAW flux and wire combination for 9%Cr-1%Mo-Nb-V heat resistant steel****Classification:** ASME / AWS A5.23 F10PZ-EG-G**Features :** •Suitable for multi-pass butt welding of 9%Cr-1%Mo-Nb-V steel

- AC current is recommended
- Excellent creep rupture strength

Redrying conditions of flux: 200~300°Cx1h**Chemical composition of wire (%) as per AWS**

	C	Si	Mn	P	S
Example	0.08	0.13	1.73	0.007	0.005
Guaranty	≤0.14	≤0.30	≤2.00	≤0.020	≤0.020
	Cr	Mo	Nb	V	Ni
Example	8.91	0.90	0.05	0.23	0.60
Guaranty	8.00~10.50	0.80~1.20	≤0.10	≤0.50	≤1.00

Chemical composition of weld metal (%) as per AWS

	C	Si	Mn	P	S
Example	0.06	0.12	1.58	0.008	0.004
Guaranty	≤0.12	≤0.60	≤2.00	≤0.025	≤0.025
	Cr	Mo	Nb	V	Ni
Example	8.31	0.88	0.03	0.21	0.55
Guaranty	8.00~10.50	0.80~1.20	≤0.15	≤0.50	≤1.00

Mechanical properties of weld metal as per AWS

	0.2%OS (MPa)	TS (MPa)	EI (%)	IV (J)	PWHT (°C×h)
Example	580	710	24	0°C: 68	740x8
Guaranty	≥610	690~830	≥16	-	745±15x1

Polarity

Example	AC
Guaranty	AC

Packages

Wire			Flux		
Dia. (mm)	Type	Weight (kg)	Mesh size	Type	Weight (kg)
1.6	spool	20			
2.4	coil	25	10x48	can	20
3.2	coil	25			
4.0	coil	25			

PF-90B9/US-90B9**TRUSTARC™****SAW flux and wire combination for 9%Cr-1%Mo-Nb-V heat resistant steel****Classification:** ASME / AWS A5.23 F9PZ-EB9-B9**Features :** •Suitable for multi-pass butt welding of 9%Cr-1%Mo-Nb-V steel

- Excellent creep rupture strength
- DCEP current is recommended.

Redrying conditions of flux: 200~300°Cx1h**Chemical composition of wire (%) as per AWS**

	C	Si	Mn	P	S	Cu	Ni
Example	0.11	0.26	0.74	0.004	0.005	0.01	0.51
Guaranty	0.07~0.13	≤0.50	≤1.25	≤0.010	≤0.010	≤0.10	≤1.00
	Cr	Mo	V	Al	Nb	N	
Example	9.30	1.05	0.23	< 0.001	0.06	0.04	
Guaranty	8.50~10.50	0.85~1.15	0.15~0.25	≤0.04	0.02~0.10	0.03~0.07	

Chemical composition of weld metal (%) as per AWS

	C	Si	Mn	P	S	Cu	Ni
Example	0.10	0.21	0.92	0.009	0.004	0.01	0.50
Guaranty	0.08~0.13	≤0.80	≤1.20	≤0.010	≤0.010	≤0.25	≤0.80
	Cr	Mo	V	Al	Nb	N	Mn+Ni
Example	9.00	0.97	0.21	0.01	0.04	0.04	1.42
Guaranty	8.00~10.50	0.85~1.20	0.15~0.25	≤0.04	0.02~0.10	0.02~0.07	≤1.50

Mechanical properties of weld metal as per AWS

	0.2%OS (MPa)	TS (MPa)	EI (%)	IV (J)	PWHT (°C×h)
Example	582	716	23	20°C: 37	760x2
Guaranty	≥530	620~758	≥17	-	760x2

Polarity

Example	DCEP
Guaranty	DCEP

Packages

Wire			Flux		
Dia. (mm)	Type	Weight (kg)	Mesh size	Type	Weight (kg)
1.6	spool	20			
2.4	coil	25	10x48	can	20
3.2	coil	25			
4.0	coil	25			

SAW Flux and Wire Combinations for Heat-Resistant Low-Alloy Steel

Trade designation	ASME AWS Class.	Type of flux	Pol.	Features	Chemical composition (%)								Mechanical properties of weld metal					
					C	Si	Mn	P	S	Mo	Others	0.2%OS (MPa)	TS (MPa)	EI (%)	IV (J)	PWHT (°C/h)		
MF-27 / US-56B	A5.23 F9P4 -EG-G	Fused	AC	•Suitable for multi-layer butt welding of Mn-Mo and Mn-Mo-Ni steels •RC: 150~350°Cx1h	Wire-Ex	0.10	0.14	1.62	0.005	0.003	0.47	Ni: 0.84 Cu: 0.08	Ex	480	560	32	-40°C: 85	635 x26
					Wire-Gt	≤0.15	≤0.35	1.40~ 2.20	≤0.018	≤0.018	0.40~ 0.70	Ni: 0.70~1.20 Cu≤0.30						
					Weld-Ex	0.08	0.28	1.05	0.009	0.002	0.45	Ni: 0.87 Cu: 0.08	Gt	≥540	620~ 760	≥17	-40°C ≥27	620±15 x1
					Weld-Gt	≤0.12	≤0.50	0.90~ 1.80	≤0.020	≤0.020	0.40~ 0.70	Ni: 0.70~1.20 Cu≤0.30						
PF-200 / US-56B	A5.23 F9P4 -EG-G	Bonded	AC	•Suitable for multi-layer butt welding of Mn-Mo and Mn-Mo-Ni steels •RC: 200~300°Cx1h	Wire-Ex	0.10	0.14	1.62	0.007	0.003	0.47	Ni: 0.84 Cu: 0.08	Ex	490	580	30	-40°C: 182	620 x11
					Wire-Gt	≤0.15	≤0.35	1.40~ 2.20	≤0.018	≤0.018	0.40~ 0.70	Ni: 0.70~1.20 Cu≤0.30						
					Weld-Ex	0.08	0.11	1.33	0.007	0.003	0.43	Ni: 0.83 Cu: 0.08	Gt	≥540	620~ 760	≥17	-40°C ≥27	620±15 x1
					Weld-Gt	≤0.12	≤0.50	0.90~ 1.80	≤0.020	≤0.020	0.40~ 0.70	Ni: 0.70~1.20 Cu≤0.30						

Note: Welding tests are as per AWS. Wire-Ex: Example of wire, Wire-Gt: Guaranty of wire, Ex: Example of weld metal (polarity: AC), Gt: Guaranty of weld metal (polarity: AC)

Weld-Ex: Example of weld metal, Weld-Gt: Guaranty of weld metal

Approvals

MF-27 / US-56B	TÜV
----------------	-----

Diameter of wire (mm)

US-56B	3.2, 4.0, 4.8
--------	---------------

Mesh size of flux

MF-27	48xD
PF-200	10x48

SAW Flux and Wire Combination for Heat -Resistant Low-Alloy Steel

Trade designation	ASME AWS Class.	Type of flux	Pol.	Features	Chemical composition (%)								Mechanical properties of weld metal						
					C	Si	Mn	P	S	Cu	Cr	Mo	0.2%OS (MPa)	TS (MPa)	EI (%)	IV (J)	PWHT (°Cxh)		
MF-29A/ US-511	A5.23 F7PZ -EG-B2	Fused	AC	•Suitable for multi-layer butt welding of 1~1.25%Cr-0.5%Mo steels •RC: 150~350°Cx1h	Wire-Ex	0.12	0.17	0.61	0.004	0.003	0.12	1.48	0.52	Ex	440	580	28	20°C: 28	650 x20
					Wire-Gt	0.05~ 0.14	≤0.35	0.35~ 0.85	≤0.020	≤0.020	≤0.30	1.30~ 1.75	0.40~ 0.65						
					Weld-Ex	0.09	0.25	0.78	0.008	0.003	0.12	1.32	0.52	Gt	≥400	480~ 660	≥22	-	690±15 x1
					Weld-Gt	0.05~ 0.15	≤0.80	≤1.20	≤0.030	≤0.030	≤0.35	1.00~ 1.50	0.40~ 0.65						
MF-29A/ US-521	A5.23 F8P2 -EG-B3	Fused	AC	•Suitable for multi-layer butt welding of 2.25%Cr-1%Mo steel •RC: 150~350°Cx1h	Wire-Ex	0.07	0.16	0.61	0.008	0.003	0.12	2.52	1.05	Ex	480	600	24	-29°C: 68	690 x10
					Wire-Gt	≤0.14	≤0.35	0.30~ 0.85	≤0.025	≤0.025	≤0.30	2.35~ 2.80	0.90~ 1.20						
					Weld-Ex	0.09	0.17	0.79	0.011	0.002	0.12	2.38	1.02	Gt	≥470	550~ 690	≥20	-29°C: ≥27	690±15 x1
					Weld-Gt	0.05~ 0.15	≤0.80	≤1.20	≤0.030	≤0.030	≤0.35	2.00~ 2.50	0.90~ 1.20						
PF-200S/ US-502	A5.23 F7P2 -EG-B6	Bonded	AC	•Suitable for multi-layer butt welding of 5%Cr-0.5%Mo steel •RC: 200~300°Cx1h	Wire-Ex	0.07	0.18	0.50	0.008	0.002	0.12	5.50	0.55	Ex	460	590	32	-29°C: 133	720x1
					Wire-Gt	≤0.15	≤0.35	0.30~ 0.85	≤0.025	≤0.025	≤0.30	4.80~ 6.00	0.40~ 0.65						
					Weld-Ex	0.06	0.21	0.78	0.012	0.002	0.12	5.25	0.55	Gt	≥400	480~ 660	≥22	-29°C: ≥27	745±15 x1
					Weld-Gt	≤0.12	≤0.80	≤1.20	≤0.030	≤0.030	≤0.35	4.50~ 6.00	0.40~ 0.65						

Note: Welding tests are as per AWS. Wire-Ex: Example of wire, Wire-Gt: Guaranty of wire, Ex: Example of weld metal (polarity: AC), Gt: Guaranty of weld metal (polarity: AC)

Weld-Ex: Example of weld metal, Weld-Gt: Guaranty of weld metal

Diameter of wire (mm)	
US-511	1.2, 1.6, 2.4, 3.2, 4.0, 4.8, 6.4
US-521	1.6, 2.4, 3.2, 4.0, 4.8
US-502	3.2, 4.0, 4.8

Mesh size of flux	
MF-29A	48XD
PF-200S	10x48

Welding Consumables and Proper Welding Conditions for

- **Shielded Metal Arc Welding (SMAW)**
- **Flux Cored Arc Welding (FCAW)**
- **Gas Metal Arc Welding (GMAW)**
- **Gas Tungsten Arc Welding (GTAW)**
- **Submerged Arc Welding (SAW)**

For Stainless Steel

■ A guide for selecting welding consumables (Trade designations)

Steel type	Key note for application	SMAW
304	•General	NC-38
304L	•Cryogenic temperatures	NC-38LT
	•Low carbon 0.04% max.	NC-38L
	•High temperature service and solution treatment	NC-38L
304H	•High temperatures	NC-38H
304N2	•General	-
Dissimilar metals	•General	NC-39 NC-39L NC-39MoL NC-32
	•High temperature service and solution treatment	-
316	•General	NC-36
316L	•Cryogenic temperatures	NC-36LT
	•Low carbon (0.04% max.)	NC-36L
	•High temperature service and solution treatment	NC-36L
316H	•High temperatures	-
316L Mod.	•Urea (Low ferrite content)	NC-316MF
317L	•Low carbon (0.04% max.)	NC-317L
347	•General	NC-37
	•Low carbon	NC-37L
	•High temperatures	NC-37
321	•General	NC-37
	•High temperatures	NC-37
310S	•General	NC-30
-	•Duplex stainless	NC-329M
410	•General	CR-40
405, 409	•Overlaying in cladding	CR-40Cb
	•Underlaying in cladding	CR-43Cb CR-43CbS
-	•Low carbon martensite	-
409, 430, 436 410L	•Car exhaust system	-

FCAW	GMAW	GTAW	SAW
DW-308 DW-308LP	MG-S308	TG-S308	PF-S1 / US-308
DW-308LT	-	TG-S308L	PF-S1 / US-308L
DW-308L DW-308LP	MG-S308LS	TG-S308L TG-X308L	PF-S1 / US-308L
DW-308LH	-	-	-
DW-308H	-	-	-
DW-308N2	-	-	-
DW-309 DW-309L DW-309MoL DW-309LP DW-309MoLP DW-312	MG-S309 MG-S309LS	TG-S309 TG-S309L TG-X309L	PF-S1 / US-309 PF-S1 / US-309L
DW-309LH	-	-	-
DW-316 DW-316LP	-	TG-S316	PF-S1M / US-316 (single pass) PF-S1 / US-316 (multi-pass)
DW-316LT	-	TG-S316L	-
DW-316L DW-316LP	MG-S316LS	TG-S316L TG-X316L	PF-S1M / US-316L (single pass) PF-S1 / US-316L (multi-pass)
DW-316LH	-	-	-
DW-316H	-	-	-
-	-	N04051 TG-S310MF	-
DW-317L	-	TG-S317L	PF-S1 / US-317L
DW-347	MG-S347S	TG-S347 TG-X347	PF-S1 / US-347
-	MG-S347LS	TG-S347L	-
DW-347H	MG-S347S	TG-S347	-
DW-347	MG-S347S	TG-S347	PF-S1 / US-347
DW-347H	MG-S347S	TG-S347	-
DW-310	-	TG-S310	-
DW-329A DW-329AP DW-2101	-	TG-S329M	-
-	MG-S410	TG-S410	PF-S4M / US-410
DW-410Cb	-	TG-S410Cb	-
DW-430CbS	-	-	-
MX-A135N MX-A410NM	-	-	-
MX-A430M	MG-S430M	-	-

For Stainless Steel

■ Tips for better welding results for individual welding processes

SMAW

- (1) Use proper welding currents because the use of an excessive current causes overheating electrodes and thereby welding usability and weld metal mechanical properties can be deteriorated.
- (2) Keep the arc as short as possible.
- (3) Control the weaving width of electrode within two and a half times the diameter of the electrode.

FCAW

1. Features:

- (1) DW stainless flux-cored wires are cost-effective wires because of high welding efficiency with the deposition rate 2-4 times as high as those of stick electrodes as shown in Fig. 1 and deposition efficiency of about 90%.
- (2) DW stainless wires offer a wider range of current and voltage in comparison with solid wire as shown in Fig. 2, which facilitates easier application for both semi-automatic and automatic welding.
- (3) DW stainless series has excellent usability and weldability with stable arc, low spatter, good slag removal, smooth bead appearance, and high X-ray soundness.

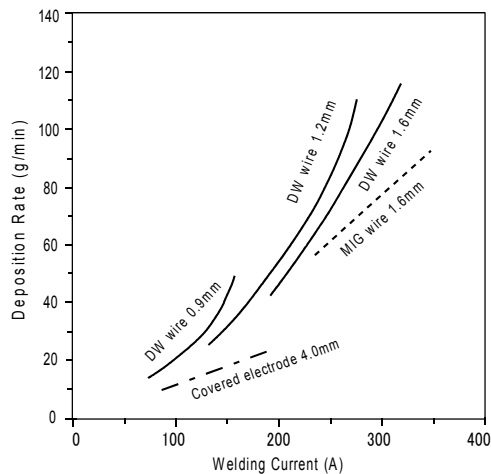

Fig. 1 Deposition rate as a function of welding current

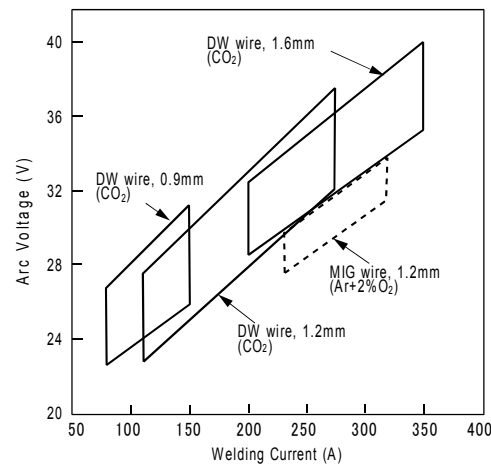

Fig. 2 Proper ranges of welding current and arc voltage

2. Notes on usage

- (1) Welding power source:
Use a DC power source with constant voltage and the polarity DC-EP. Inverter-type welding power sources can also be used. When the use of a certain pulsed arc power source causes much spatter, use the wire with ordinary currents, turning off the pulse switch.
- (2) Shielding gas:
Use CO₂ for shielding gas for general applications. Ar-CO₂ mixtures with 20-50% CO₂ can also be used, but compared with CO₂, porosity (pit and blowhole) is apt to occur. The proper flow rate of shielding gas is 20-25 liter/min.
- (3) Wire extension:
Keep the wire extension at about 15 mm for 0.9-mm wire and 15-20 mm for 1.2- and 1.6-mm wire. The use of a shorter wire extension may cause pit and worm-tracking porosity. The wire extension in welding with an Ar-CO₂ mixture should be 5 mm longer than in use of CO₂.
- (4) Protection against wind:
When wind velocity at the vicinity of an arc is more than 1 m/sec., blowhole is apt to occur, and dissolution of nitrogen into the weld metal may deteriorate slag removal and decrease the ferrite content of the weld metal, thereby causing hot cracking. To prevent these problems, use an adequate shielding gas flow rate and a windscreen.
- (5) Welding fumes:
Flux-cored wires generate much more welding fumes in terms of the amount of fumes at unit time in comparison with that of covered electrodes. To protect welders from harmful welding fumes, be sure to use a local ventilator and an appropriate respirator.
- (6) Storage of wire:
Once a DW stainless wire picked up moisture, it cannot be dried at high temperatures, unlike covered electrodes. If a DW wire was left in a wire feeder in a high-temperature high-humidity atmosphere in summer season, a wet environment in rainy season or a dewfall environment at night in winter season, the use of it may cause pit and worm-tracking porosity due to moisture pick up. Once a wire was unpacked, the wire should be kept in an area of low humidity, taking appropriate preventive measures against dewfall water and dust.

For Stainless Steel

3. Applications

(1) Butt welding:

Applicable plate thicknesses are 2 mm or larger with a 1.2mm wire and 5 mm or larger with a 1.6mm wire in flat position. P-series wires enable to weld thin plates with 3-4 mm thickness in vertical position. One-side welding can be applied for similar-shape grooves in flat, horizontal and vertical positions by using a backing material of FBB-3 (T size). In this case, the root opening should be about 3-4 mm to obtain good reverse beads.

(2) Horizontal fillet welding:

Proper welding speeds are approximately 30-70 cm/min in horizontal fillet welding. With a 309 type wire, dissimilar-metal welding of stainless steel to carbon steel can be done in the same welding condition as used for welding stainless steels. However to secure the ferrite content of weld metal, welding currents should be 200A or lower and welding speeds should be 40 cm/mm or slower with a 1.2mm wire.

(3) Overlaying and joining of clad steels:

The 1st layer of overlaying onto carbon steel should be welded with a 309 (or 309MoL) type wire by the half lapping method. In case where the dilution by the base metal is excessive, the ferrite content of the weld metal decreases and thereby hot cracking may occur. Therefore, it is important to use appropriate welding conditions to control the dilution particularly for the first layer. In order to obtain the proper dilution ratio, welding currents should be 200A or lower and welding speeds should be 20-40 cm/min with a 1.2mm wire. With a 1.6mm wire, use welding currents in the 200-250 range and welding speeds in the 20-30 cm/min range. Refer to Fig. 3.

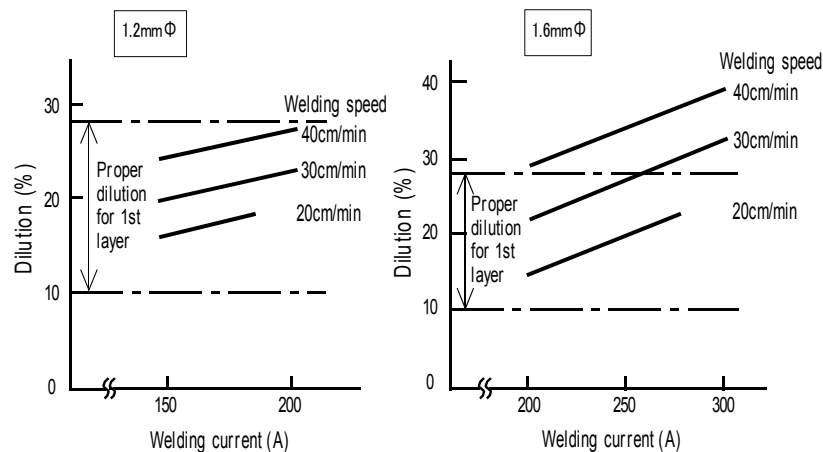

Fig. 3 Dilution ratios as a function of welding currents

GMAW

(1) Polarity:

DC-EP is suitable.

(2) Shielding gas:

98% Ar-2%O₂ mixture is recommended for general applications. Proper gas flow rates range in 20-25 l/min. Ar-CO₂ mixture is not suitable for low carbon stainless steel (Type 304L) because the carbon content of deposited metal increases.

(3) Arc length:

GMAW of stainless steel generally uses the spray arc transfer mode due to lower spatter generation. Adjust arc voltage so that arc length becomes 4-6 mm. When arc length is excessively short, blowholes are apt to occur. Inversely, when arc length is excessively long, the wetting of deposited metal on the base metal becomes poor.

(4) Protection against wind:

GMAW is likely to be influenced by wind and thereby blowholes may occur. Use a windscreen to protect the arcing area against wind when the wind velocity near the arc is 0.5m/sec or more.

(5) Pulsed arc welding:

In pulsed arc welding, a stable spray arc can be obtained even with low welding currents. Pulsed arc is suitable for overlaying, welding of thin plates and vertical welding.

GTAW

(1) Polarity:

DC-EN is suitable.

(2) Shielding gas:

Argon gas is mainly used for shielding. Suitable flow rates of shielding gas are in the range of 7-15 l/min. at 100-200A of welding current and 12-20 l/min. at 200-300A in manual GTAW.

(3) Torch:

Two types of GTAW torches are available. One has a gas lens, another has no gas lens. A torch with a gas lens provides better shielding effect preventing the weld bead from oxidation since the gas lens can provide a regular gas flow.

(4) Tungsten electrode extension:

Proper tungsten electrode extensions are generally in the range of 4-5 mm. In the case where shielding effect tends to be lower as in welding corner joint, tungsten extension is recommended to be 2-3 mm. In welding of deep groove joints, tungsten extension should be longer as 5-6 mm.

(5) Arc length:

Proper arc lengths are in the range of 1-3 mm. When it is excessively long, the shielding effect becomes poor.

(6) One-side welding without backing materials:

In the case of one-side welding without backing materials, adopt back shielding in order to prevent oxidation of the penetration bead. However, with a flux-cored filler rod for GTAW, sound penetration bead can be obtained without back shielding.

(7) Fully austenitic type filler wires:

With a fully austenitic type filler wire (e.g., TGS-310, TGS-310MF), use lower welding currents and welding speeds to prevent hot cracking.

For Stainless Steel

Ferrite content measuring methods for austenitic stainless steel weld metal

Method	Principles of measuring ferrite content
Ferrite Indicator:	Comparing the magnetic attraction between a standard ferrite percent insert and a test specimen
Ferrite Scope:	Measuring a change of magnetic induction affected by the ferrite content of a test specimen
Magne Gage:	Measuring the pull off force necessary to detach a standard permanent magnet from a test specimen
Structure Diagram:	Calculating Ni equivalent and Cr equivalent of the chemical composition of a test specimen and reading the crossing point of the two equivalents in a structure diagram. Three structure diagrams are available: Schaeffler diagram, DeLong diagram and WRC diagram. See Figs. 1, 2 and 3.
Point Counting:	Calculating the area percentage of ferrite in the microstructure of a test specimen, by using a optical microscope

Fig. 1 Schaeffler Diagram

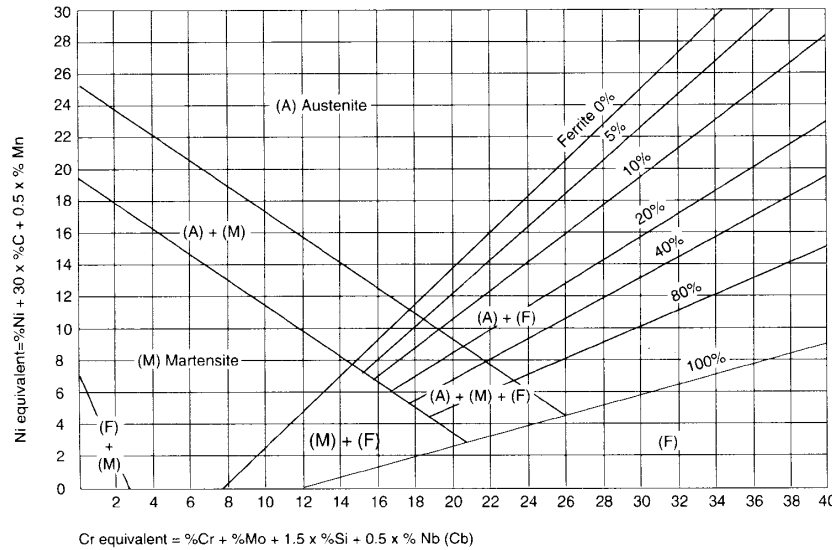

Fig. 2 DeLong Diagram

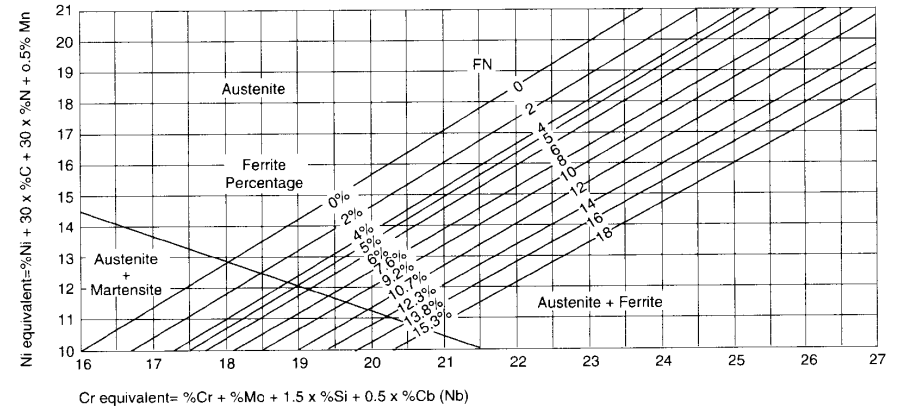
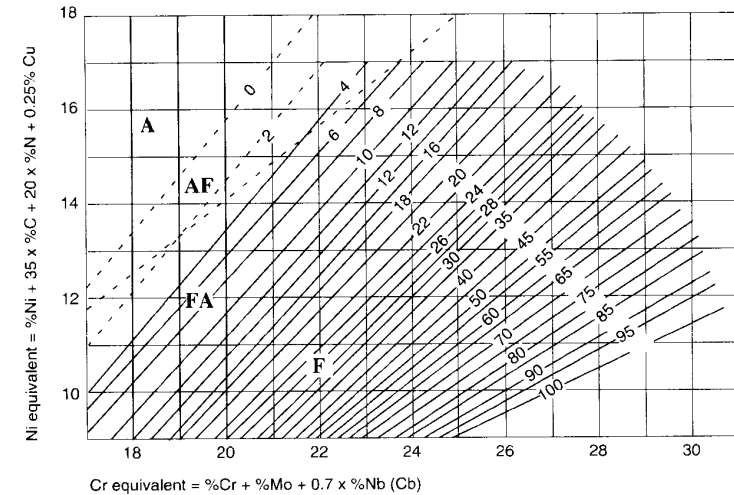

Fig. 3 WRC Diagram



A, AF, FA, F stand for solidification modes
 A : Austenitic single phase (γ)
 AF : Primary phase (γ) + Eutectic Ferrite (δ)
 FA : Primary phase (δ) + Peritectic / Eutectic phase (γ)
 F : δ Single phase Solidification

NC-38



Lime titania type covered electrode for 18%Cr-8%Ni stainless steel

Classification: ASME / AWS A5.4 E308-16
JIS Z3221 D308-16
Features : •Applicable for 304 type steel
•Suitable for butt and fillet welding
Redrying Conditions: 150~200°Cx0.5~1h

Welding Positions:

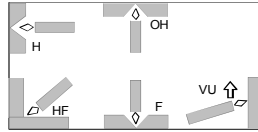

Chemical composition of all-weld metal (%) as per AWS

	C	Si	Mn	P	S	Ni	Cr
Example	0.07	0.35	1.69	0.023	0.002	9.58	20.49
Guaranty	≤0.08	≤0.90	0.5~2.5	≤0.04	≤0.03	9.0~11.0	18.0~21.0

Mechanical properties of all-weld metal as per AWS

	0.2%OS (MPa)	TS (MPa)	EI (%)	IV (J)
Example	410	600	46	0°C: 74
Guaranty	-	≥550	≥35	-

Recommended welding parameters

Dia.	2.0mm	2.6mm	3.2mm	4.0mm	5.0mm
F, HF, H	25~55A	50~85A	70~115A	95~145A	135~180A
VU, OH	20~50A	45~80A	65~110A	85~135A	-

Polarity

Example	AC
Guaranty	AC, DC-EP

Approvals

AB	NV	NK
MG(E308-16)	308	KD308

Packages

Dia. (mm)	Length (mm)	Weight per pack (kg)	Weight per carton (kg)	Weight per piece (g)
2.0	250	2	20	11
2.6	300	2	20	20
3.2	350	5	20	36
4.0	350	5	20	54
5.0	350	5	20	80

NC-38L



Lime titania type covered electrode for low carbon 18%Cr -8%Ni stainless steel

Classification: ASME / AWS A5.4 E308L-16
JIS Z3221 D308L-16
Features : •Applicable for 304L type steel
•Suitable for butt and fillet welding
•Lower carbon content than **NC-38**
Redrying Conditions: 150~200°Cx0.5~1h

Welding Positions:

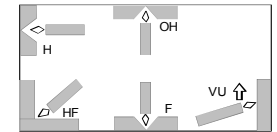

Chemical composition of all-weld metal (%) as per AWS

	C	Si	Mn	P	S	Ni	Cr
Example	0.034	0.33	1.43	0.022	0.006	9.57	20.07
Guaranty	≤0.04	≤0.90	0.5~2.5	≤0.04	≤0.03	9.0~11.0	18.0~21.0

Mechanical properties of all-weld metal as per AWS

	0.2%OS (MPa)	TS (MPa)	EI (%)	IV (J)
Example	410	580	48	0°C: 78
Guaranty	-	≥520	≥35	-

Recommended welding parameters

Dia.	2.0mm	2.6mm	3.2mm	4.0mm	5.0mm
F, HF, H	25~55A	50~85A	70~115A	95~145A	135~180A
VU, OH	20~50A	45~80A	65~110A	85~135A	-

Polarity

Example	AC
Guaranty	AC, DC-EP

Approvals

LR	BV	NK	Others
304Lm(Chem.)	308L	KD308L	GL

Packages

Dia. (mm)	Length (mm)	Weight per pack (kg)	Weight per carton (kg)	Weight per piece (g)
2.0	250	2	20	9
2.6	300	2	20	18
3.2	350	5	20	33
4.0	350	5	20	51
5.0	350	5	20	79

NC-38H



Lime titania type covered electrode for 18%Cr-8%Ni stainless steel for high temperatures

Classification: ASME / AWS A5.4 E308H-16
JIS Z3221 D308-16

Features : •Applicable for 304 type steel for high temperature
•Low ferrite, low impurity, and excellent mechanical properties at high temperatures
•Suitable for butt and fillet welding

Redrying Conditions: 150~200°Cx0.5~1h

Welding Positions:

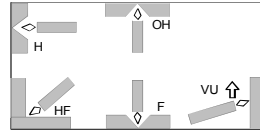

Chemical composition of all-weld metal (%) as per AWS

	C	Si	Mn	P	S	Ni	Cr
Example	0.06	0.45	1.95	0.020	0.002	9.50	19.50
Guaranty	0.04~0.08	≤0.90	0.5~2.5	≤0.04	≤0.03	9.0~11.0	18.0~21.0

Mechanical properties of all-weld metal as per AWS

	0.2%OS (MPa)	TS (MPa)	EI (%)	IV (J)
Example	403	572	48	0°C: 79
Guaranty	-	≥550	≥35	-

Recommended welding parameters

	Dia.	2.6mm	3.2mm	4.0mm	5.0mm
F, HF, H	50~85A	70~115A	95~145A	135~180A	
VU, OH	45~80A	65~110A	85~135A		-

Polarity

Example	AC
Guaranty	AC, DC-EP

Packages

Dia. (mm)	Length (mm)	Weight per pack (kg)	Weight per carton (kg)	Weight per piece (g)
2.6	300	2	20	20
3.2	350	5	20	36
4.0	350	5	20	54
5.0	350	5	20	80

NC-39



Lime titania type covered electrode for 22%Cr-12%Ni stainless steel and dissimilar metals

Classification: ASME / AWS A5.4 E309-16
JIS Z3221 D309-16

Features : •Suitable for dissimilar-metal joint and underlaying on ferritic steels in stainless steel weld metal overlaying

Redrying Conditions: 150~200°Cx0.5~1h

Welding Positions:

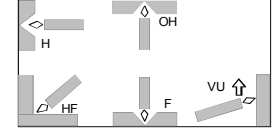

Chemical composition of all-weld metal (%) as per AWS

	C	Si	Mn	P	S	Ni	Cr
Example	0.08	0.53	1.50	0.020	0.003	12.72	23.97
Guaranty	≤0.15	≤0.90	0.5~2.5	≤0.04	≤0.03	12.0~14.0	22.0~25.0

Mechanical properties of all-weld metal as per AWS

	0.2%OS (MPa)	TS (MPa)	EI (%)	IV (J)
Example	410	590	39	0°C: 62
Guaranty	-	≥550	≥30	-

Recommended welding parameters

	Dia.	2.0mm	2.6mm	3.2mm	4.0mm	5.0mm
F, HF, H	25~55A	50~85A	70~115A	95~145A	135~180A	
VU, OH	20~50A	45~80A	65~110A	85~135A		-

Polarity

Example	AC
Guaranty	AC, DC-EP

Approvals

AB	LR	NV	BV	NK	Others
MG(E309-16)	SS/CMn m(Chem.)	309, MG	MG(E309-16)	KD309	GL, CCS

Packages

Dia. (mm)	Length (mm)	Weight per pack (kg)	Weight per carton (kg)	Weight per piece (g)
2.0	250	2	20	9
2.6	300	2	20	20
3.2	350	5	20	35
4.0	350	5	20	51
5.0	350	5	20	78

NC-39L



Lime titania type covered electrode for dissimilar metals

Classification: ASME / AWS A5.4 E309L-16
JIS Z3221 D309L-16

Features : •Suitable for dissimilar-metal joint and underlaying on ferritic steels in stainless steel weld metal overlaying
•Lower carbon content than **NC-39**

Redrying Conditions: 150~200°Cx0.5~1h

Welding Positions:

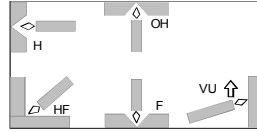

Chemical composition of all-weld metal (%) as per AWS

	C	Si	Mn	P	S	Ni	Cr
Example	0.030	0.60	1.50	0.020	0.005	12.50	23.13
Guaranty	≤0.04	≤0.90	0.5~2.5	≤0.04	≤0.03	12.0~14.0	22.0~25.0

Mechanical properties of all-weld metal as per AWS

	0.2%OS (MPa)	TS (MPa)	EI (%)	IV (J)
Example	410	560	42	0°C: 67
Guaranty	-	≥520	≥30	-

Recommended welding parameters

	2.0mm	2.6mm	3.2mm	4.0mm	5.0mm
Dia.	2.0mm	2.6mm	3.2mm	4.0mm	5.0mm
F, HF, H	25~55A	50~85A	70~115A	95~145A	135~180A
VU, OH	20~50A	45~80A	65~110A	85~135A	-

Polarity

Example	AC
Guaranty	AC, DC-EP

Approvals

NV	BV	NK	Others
309L, MG	MG(E309L-16)	KD309L	TÜV

Packages

Dia. (mm)	Length (mm)	Weight per pack (kg)	Weight per carton (kg)	Weight per piece (g)
2.6	300	2	20	19
3.2	350	5	20	34
4.0	350	5	20	55
5.0	350	5	20	85

NC-39MoL



Lime titania type covered electrode for dissimilar metals

Classification: ASME / AWS A5.4 E309MoL-16
JIS Z3221 D309MoL-16

Features : •Suitable for dissimilar-metal joint and underlaying on ferritic steels in stainless steel weld metal overlaying
•Lower carbon content than **NC-39**

Redrying Conditions: 150~200°Cx0.5~1h

Welding Positions:

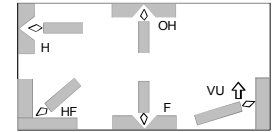

Chemical composition of all-weld metal (%) as per AWS

	C	Si	Mn	P	S	Ni	Cr	Mo
Example	0.029	0.51	1.28	0.024	0.005	12.65	23.08	2.29
Guaranty	≤0.04	≤0.90	0.5~2.5	≤0.04	≤0.03	12.0~14.0	22.0~25.0	2.0~3.0

Mechanical properties of all-weld metal as per AWS

	0.2%OS (MPa)	TS (MPa)	EI (%)	IV (J)
Example	450	630	41	0°C: 65
Guaranty	-	≥520	≥30	-

Recommended welding parameters

	2.6mm	3.2mm	4.0mm	5.0mm
Dia.	2.6mm	3.2mm	4.0mm	5.0mm
F, HF, H	50~85A	70~115A	95~145A	135~180A
VU, OH	45~80A	65~110A	85~135A	-

Polarity

Example	AC
Guaranty	AC, DC-EP

Approvals

AB	NK
MG	KD309Mo

Packages

Dia. (mm)	Length (mm)	Weight per pack (kg)	Weight per carton (kg)	Weight per piece (g)
2.6	300	2	20	19
3.2	350	5	20	33
4.0	350	5	20	54
5.0	350	5	20	85

NC-36



Lime titania type covered electrode for 18%Cr-12%Ni-2%Mo stainless steel

Classification: ASME / AWS A5.4 E316-16
JIS Z3221 D316-16

Features : •Applicable for 316 type steel
•Suitable for butt and fillet welding

Redrying Conditions: 150~200°Cx0.5~1h

Welding Positions:

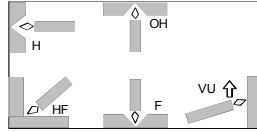

Chemical composition of all-weld metal (%) as per AWS

	C	Si	Mn	P	S	Ni	Cr	Mo
Example	0.06	0.32	1.33	0.022	0.004	11.79	19.17	2.25
Guaranty	≤0.08	≤0.90	0.5~ 2.5	≤0.04	≤0.03	11.0~ 14.0	17.0~ 20.0	2.0~ 3.0

Mechanical properties of all-weld metal as per AWS

	0.2%OS (MPa)	TS (MPa)	EI (%)	IV (J)
Example	410	570	46	0°C: 80
Guaranty	-	≥520	≥30	-

Recommended welding parameters

Dia.	2.0mm	2.6mm	3.2mm	4.0mm	5.0mm
F, HF, H	25~55A	50~85A	70~115A	95~145A	135~180A
VU, OH	20~50A	45~80A	65~110A	85~135A	-

Polarity

Example	AC
Guaranty	AC, DC-EP

Approvals

NK
KD316

Packages

Dia. (mm)	Length (mm)	Weight per pack (kg)	Weight per carton (kg)	Weight per piece (g)
2.0	250	2	20	10
2.6	300	2	20	19
3.2	350	5	20	33
4.0	350	5	20	51
5.0	350	5	20	78

NC-36L



Lime titania type covered electrode for low carbon 18%Cr-12%Ni-2%Mo stainless steel

Classification : ASME / AWS A5.4 E316L-16
JIS Z3221 D316L-16

Features : •Applicable for 316L type steel
•Suitable for butt and fillet welding
•Lower carbon content than **NC-36**

Redrying Conditions: 150~200°Cx0.5~1h

Welding Positions:

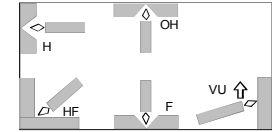

Chemical composition of all-weld metal (%) / as per AWS

	C	Si	Mn	P	S	Ni	Cr	Mo
Example	0.023	0.57	1.56	0.025	0.003	12.17	18.68	2.20
Guaranty	≤0.04	≤0.90	0.5~ 2.5	≤0.04	≤0.03	11.0~ 14.0	17.0~ 20.0	2.0~ 3.0

Mechanical properties of all-weld metal / as per AWS

	0.2%OS (MPa)	TS (MPa)	EI (%)	IV (J)
Example	420	580	45	0°C: 83
Guaranty	-	≥485	≥30	-

Recommended welding parameters

Dia.	2.0mm	2.6mm	3.2mm	4.0mm	5.0mm
F, HF, H	25~55A	50~85A	70~115A	95~145A	135~180A
VU, OH	20~50A	45~80A	65~110A	85~135A	-

Polarity

Example	AC
Guaranty	AC, DC-EP

Approvals

AB	LR	NV	BV	NK	Others
MG(E316-16)	316Lm(Chem.)	316L, MG	MG(E316L-16)	KD316L	GL

Packages

Dia. (mm)	Length (mm)	Weight per pack (kg)	Weight per carton (kg)	Weight per piece (g)
2.0	250	2	20	10
2.6	300	2	20	19
3.2	350	5	20	34
4.0	350	5	20	51
5.0	350	5	20	78

CR-40 - CR-40Cb



Lime titania type and lime type covered electrodes for 13%Cr stainless steel

Classification: ASME / AWS A5.4 E410-16: CR-40

JIS Z3221 D410-16: CR-40, D410Nb-16: CR-40Cb

- Features :**
- CR-40 (lime titania type) is suitable for 13%Cr martensitic stainless steels such as 403 and 410 types.
 - CR-40Cb (lime type) is suitable for 13%Cr martensitic stainless steels such as 403 and 410 types and 13%Cr ferritic stainless steels such as 405 type.
 - Preheat: 200~400°C (CR-40), 100~250°C (CR-40Cb)
 - PWHT: 700~760°C (CR-40), 600~760°C (CR-40Cb)

Welding Positions:

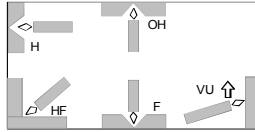

Redrying Conditions: 300~350°Cx0.5~1h

Chemical composition of all-weld metal (%) as per AWS

		C	Si	Mn	P	S	Cr	Nb
CR-40	Example	0.08	0.47	0.28	0.020	0.006	12.83	-
	Guaranty	≤0.12	≤0.90	≤1.0	≤0.04	≤0.03	11.0~13.5	-
CR-40Cb	Example	0.09	0.40	0.42	0.018	0.002	13.18	0.81
	Guaranty	≤0.12	≤0.90	≤1.00	≤0.040	≤0.030	11.0~14.0	0.50~1.50

Mechanical properties of all-weld metal as per AWS

		0.2%OS (MPa)	TS (MPa)	EI (%)	PWHT
CR-40	Example	290	510	33	850°Cx2h*
	Guaranty	-	≥450	≥20	
CR-40Cb	Example	270	500	35	850°Cx2h*
	Guaranty	-	≥450	≥20	

Recommended welding parameters

Dia.	3.2mm	4.0mm	5.0mm
F, HF, H	70~115A	95~145A	135~180A
VU, OH	65~110A	85~135A	-

Polarity

Example	AC
Guaranty	AC, DC-EP

Packages

Dia. (mm)	Length (mm)	Weight per pack (kg)	Weight per carton (kg)	Weight per piece (g)
3.2	350	5	20	31
4.0	400	5	20	53
5.0	400	5	20	78

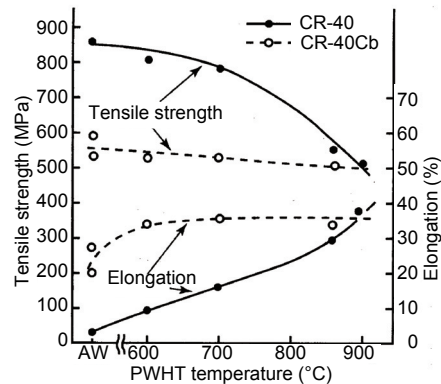

Mechanical properties at room temperature vs. postweld heat treatment temperature

CR-43 - CR-43Cb - CR-43CbS



Lime titania type and lime type covered electrodes for 17%Cr stainless steel

Classification : ASME / AWS A5.4 E430-16: CR-43

JIS Z 3221 D430-16: CR-43, D430Nb-16: CR-43Cb

- Features :**
- CR-43 (lime titania type) and CR-43Cb (lime type) are suitable for 17%Cr ferritic stainless steels such as 430 type.
 - CR-43CbS (lime type) is suitable for underlay welding on cladded side groove of 405 type cladded steel and on carbon and low alloy steels for overlaying 13%Cr stainless weld metal.
 - Preheat: 150~250°C (CR-43), 100~250°C (CR-43Cb), 100~200°C (CR-43CbS)
 - PWHT: 700~820°C (CR-43), 600~820°C (CR-43Cb, CR-43CbS)

Welding Positions:

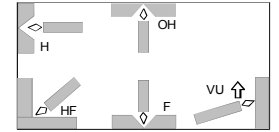

Redrying Conditions: 300~350°Cx0.5~1h

Chemical composition of all-weld metal (%) / as per AWS

		C	Si	Mn	P	S	Cr	Nb
CR-43	Example	0.09	0.60	0.27	0.021	0.003	17.65	-
	Guaranty	≤0.10	≤0.90	≤1.0	≤0.040	≤0.030	15.0~18.0	-
CR-43Cb	Example	0.09	0.46	0.40	0.020	0.002	17.24	0.80
	Guaranty	≤0.10	≤0.90	≤1.00	≤0.040	≤0.030	15.0~18.0	0.50~1.50
CR-43CbS	Example	0.05	0.36	0.39	0.016	0.003	15.41	0.97
	Guaranty	≤0.08	≤0.90	≤1.00	≤0.040	≤0.030	14.5~17.0	0.50~1.50

Mechanical properties of all-weld metal / as per AWS

		0.2%OS (MPa)	TS (MPa)	EI (%)	IV (J)	PWHT
CR-43	Example	300	560	24	0°C: 5	770x2h*
	Guaranty	-	≥450	≥20	-	
CR-43Cb	Example	290	520	33	0°C: 75	770x2h*
	Guaranty	-	≥480	≥20	-	
CR-43CbS	Example	300	600	26	-	770x2h*
	Guaranty	-	≥480	≥16	-	

* FC to 600°C, followed by AC

Recommended welding parameters

Dia.	3.2mm	4.0mm	5.0mm
F, HF, H	70~115A	95~145A	135~180A
VU, OH	65~110A	85~135A	-

Polarity

Example	AC
Guaranty	AC, DC-EP

Packages

Dia. (mm)	Length (mm)	Weight per pack (kg)	Weight per carton (kg)	Weight per piece (g)
3.2	350	5	20	31
4.0	400	5	20	55
5.0	400	5	20	78

Covered Electrodes for Stainless Steel

Trade designation	ASME AWS Class.	Type of covering	Pol.	Features	WP	Chemical		composition of all-weld metal (%)							Mechanical properties of all-weld metal				
						C	Si	Mn	P	S	Ni	Cr	Mo	0.2%OS (MPa)	TS (MPa)	EI (%)	IV (J)		
NC-38LT	A5.4 E308L-16	Lime titania	AC	•Suitable for 18%Cr-8%Ni stainless steel for cryogenic temperature service •RC: 150~200°Cx 0.5~1h	F	Ex	0.034	0.38	2.12	0.022	0.002	10.89	18.36	-	Ex	370	540	51	-196°C: 52
			DC-EP		H VU OH	Gt	≤0.04	≤0.90	0.5~2.5	≤0.04	≤0.03	9.0~11.0	18.0~21.0	≤0.75	Gt	-	≥520	≥35	-196°C: ≥34
NC-36LT	A5.4 E316L-16	Lime titania	AC	•Suitable for 18%Cr-12%Ni-2%Mo stainless steel for cryogenic temperature service •RC: 150~200°Cx 0.5~1h	F	Ex	0.030	0.52	2.02	0.021	0.003	13.06	17.28	2.25	Ex	390	530	44	-196°C: 40
			DC-EP		H VU OH	Gt	≤0.04	≤0.90	0.5~2.5	≤0.04	≤0.03	11.0~14.0	17.0~20.0	2.0~3.0	Gt	-	≥485	≥30	-196°C: ≥27
NC-317L	A5.4 E317L-16	Lime titania	AC	•Suitable for low carbon 19%Cr-13%Ni-3%Mo stainless steel •RC: 150~200°Cx 0.5~1h	F	Ex	0.030	0.50	1.17	0.027	0.004	13.28	19.11	3.50	Ex	440	600	39	-
			DC-EP		H VU OH	Gt	≤0.04	≤0.90	0.5~2.5	≤0.04	≤0.03	12.0~14.0	18.0~21.0	3.0~4.0	Gt	-	≥520	≥30	-

Note: Welding tests are as per AWS. Ex: Example (polarity: AC),

Gt: Guaranty (polarity: as specified above)

■ Approvals

NC-38LT LR, NV, NK

■ Diameter and Length (mm)

Dia.	2.6	3.2	4.0	5.0
NC-38LT	300	350	350	350
NC-36LT	300	350	350	350
NC-317L	300	350	350	-

Trade designation	ASME AWS Class.	Type of covering	Pol.	Features	WP	Chemical		composition of all-weld metal (%)							Mechanical properties of all-weld metal				
						C	Si	Mn	P	S	Ni	Cr	Others	0.2%OS (MPa)	TS (MPa)	EI (%)	IV (J)		
NC-37	A5.4 E347-16	Lime titania	AC	•Suitable for 18%Cr-8%Ni-Nb stainless steel •RC: 150~200°C x0.5~1h	F	Ex	0.060	0.60	1.66	0.018	0.002	9.82	20.22	Nb : 0.67	Ex	470	670	34	-
			DC-EP		H VU OH	Gt	≤0.08	≤0.90	0.5~2.5	≤0.04	≤0.03	9.0~11.0	18.0~21.0	8xC%~1.00	Gt	-	≥520	≥30	-
NC-37L	A5.4 E347-16	Lime titania	AC	•Suitable for modified stainless steel for urea plant in cryogenic temperature service •RC: 150~200°C x0.5~1h	F	Ex	0.035	0.58	2.33	0.022	0.004	9.42	18.80	Nb: 0.52	Ex	420	600	45	-
			DC-EP		H VU OH	Gt	≤0.04	≤0.90	0.5~2.5	≤0.04	≤0.03	9.0~11.0	18.0~21.0	8xC%~1.00	Gt	-	≥520	≥30	-
NC-316MF	-	Lime titania	AC	•Suitable for duplex stainless steel •RC: 150~200°C x0.5~1h	F	Ex	0.037	0.33	5.39	0.014	0.002	17.13	18.80	Mo: 2.85	Ex	370	520	44	-257°C: 70
			DC-EP		H VU OH	Gt	≤0.04	≤0.90	4.00~7.00	≤0.030	≤0.020	15.00~18.00	17.00~19.50	Mo: 2.20~3.00	Gt	-	≥480	≥35	-
NC-329M	-	Lime titania	AC	•Suitable for duplex stainless steel •RC: 150~200°C x0.5~1h	F	Ex	0.030	0.71	0.62	0.013	0.002	9.44	24.51	Mo: 3.25 N: 0.16	Ex	640	860	28	0°C: 70
			DC-EP		H VU OH	Gt	≤0.04	≤0.90	0.50~2.50	≤0.040	≤0.030	8.00~10.00	23.00~25.00	Mo: 2.50~4.00	Gt	-	≥620	≥18	-

Note: Welding tests are as per AWS. Ex: Example (polarity: AC),

Gt: Guaranty (polarity: as specified above)

■ Approvals

NC-37L TÜV

■ Diameter and Length (mm)

Dia.	2.6	3.2	4.0	5.0
NC-37	250	300	350	350
NC-37L	300	350	350	350
NC-316MF	300	350	350	350
NC-329M	-	350	350	-

DW-308**PREMIARC™****Rutile type flux cored wire for 18%Cr-8%Ni stainless steel**

Classification: ASME / AWS A5.22 E308T0-1 /4
EN ISO 17633-A-T Z 19 9 R C/M 3
JIS Z3323 YF308C

Features : •Applicable for 304 type steel
•Suitable for flat and horizontal fillet welding

Shielding gas: CO₂ or Ar-CO₂ mixture

Polarity: DC-EP

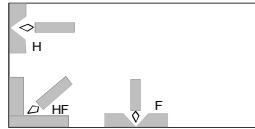
Welding positions:**Chemical composition of all-weld metal (%) as per AWS (Shielding gas: CO₂)**

	C	Si	Mn	P	S	Ni	Cr	Mo	Cu
Example	0.050	0.57	1.52	0.020	0.009	9.68	19.72	0.02	0.03
Guaranty	≤0.08	≤1.00	0.50~ 2.50	≤0.040	≤0.030	9.00~ 11.00	18.00~ 21.00	≤0.50	≤0.50

Mechanical properties of all-weld metal as per AWS (Shielding gas: CO₂)

	0.2%OS (MPa)	TS (MPa)	EI (%)	IV (J)
Example	390	570	41	0°C: 39
Guaranty	-	≥550	≥35	-

Recommended welding parameters

	0.9mm	1.2mm	1.6mm
Dia.	0.9mm	1.2mm	1.6mm
F, HF	80~150A	130~270A	190~340A
H	90~130A	150~220A	220~270A

Approvals

AB	NK	Others
MG	KW308G(C)	CWB

Packages

Dia. (mm)	Type	Weight (kg)
0.9	Spool	5, 12.5
1.2	Spool	12.5
1.6	Spool	12.5

DW-308L**PREMIARC™****Rutile type flux cored wire for low carbon 18%Cr-8%Ni stainless steel**

Classification: ASME / AWS A5.22 E308LT0-1/4
EN ISO 17633-A-T 19 9 L R C/M 3
JIS Z3323 YF308LC

Features: •Applied for 304L type steel
•Suitable for flat and horizontal fillet welding
•Lower carbon content than **DW-308**

Shielding gas: CO₂ or Ar-CO₂ mixture

Polarity: DC-EP

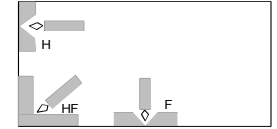
Welding positions:**Chemical composition of all-weld metal (%) as per AWS (Shielding gas: CO₂)**

	C	Si	Mn	P	S	Ni	Cr	Mo	Cu
Example	0.027	0.56	1.49	0.019	0.008	10.02	19.53	0.02	0.03
Guaranty	≤0.040	≤1.00	0.50~ 2.50	≤0.040	≤0.030	9.00~ 11.00	18.00~ 21.00	≤0.50	≤0.50

Mechanical properties of all-weld metal as per AWS (Shielding gas: CO₂)

	0.2%OS (MPa)	TS (MPa)	EI (%)	IV (J)
Example	370	550	42	0°C: 41
Guaranty	-	≥520	≥35	-

Recommended welding parameters

	0.9mm	1.2mm	1.6mm
Dia.	0.9mm	1.2mm	1.6mm
F, HF	80~150A	130~270A	190~340A
H	90~130A	150~220A	220~270A

Approvals

AB	LR	NV	NK	Others
MG	304L S (Chem. Cryo.)	308LMS	KW308LG(C)	GL, CWB, TÜV

Packages

Dia. (mm)	Type	Weight (kg)
0.9	Spool	5, 12.5
1.2	Spool	12.5
1.6	Spool	12.5

DW-308LP



Rutile type flux cored wire for low carbon 18%Cr-8%Ni stainless steel

Classification: ASME / AWS A5.22 E308LT1-1/4
EN ISO 17633-A-T 19 9 L P C/M 1
JIS Z3323 YF308LC

Features: •Applicable for 304 and 304L type steel
•Suitable for butt and fillet welding in all positions including vertical downward
•Lower carbon content than **DW-308**

Shielding gas: CO₂ or Ar-CO₂ mixture

Polarity: DC-EP

Welding positions:

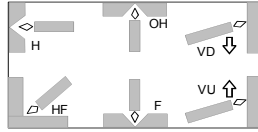

Chemical composition of all-weld metal (%) as per AWS (Shielding gas: CO₂)

	C	Si	Mn	P	S	Ni	Cr	Mo	Cu
Example	0.027	0.55	1.51	0.022	0.010	9.89	19.45	0.02	0.03
Guaranty	≤0.040	≤1.00	0.50~ 2.50	≤0.040	≤0.030	9.00~ 11.00	18.00~ 21.00	≤0.50	≤0.50

Mechanical properties of all-weld metal as per AWS (Shielding gas: CO₂)

	0.2%OS (MPa)	TS (MPa)	EI (%)	IV (J)
Example	380	550	45	0°C: 57
Guaranty	-	≥520	≥35	-

Recommended welding parameters

	Dia.	1.2mm	Dia.	1.2mm
F, HF	130~270A	OH	150~200A	
H	150~220A	VD	150~200A	
VU	130~220A			

VD position: multi-pass welding is not recommended.

Approvals

AB	LR	NV	BV	NK	Others
MG	304LMS (Chem. Cryo.)	308L	308LBT	KW308LG(C)	KR, CWB

Packages

Dia. (mm)	Type	Weight (kg)
1.2	Spool	12.5

DW-309



Rutile type flux cored wire for dissimilar metals

Classification: ASME / AWS A5.22 E309T0-1/4
EN ISO 17633-A-T Z 23 12 R C/M 3
JIS A3323 YF309C

Features : •Suitable for dissimilar-metal joint and underlaying on ferritic steels for overlaying stainless steel weld metals

Shielding gas: CO₂ or Ar-CO₂ mixture

Polarity: DC-EP

Welding positions:

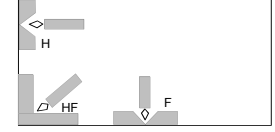

Chemical composition of all-weld metal (%) as per AWS (Shielding gas: CO₂)

	C	Si	Mn	P	S	Ni	Cr	Mo	Cu
Example	0.035	0.58	1.22	0.021	0.009	12.48	24.03	0.03	0.02
Guaranty	≤0.10	≤1.00	0.50~ 2.50	≤0.040	≤0.030	12.00~ 14.00	22.00~ 25.00	≤0.50	≤0.50

Mechanical properties of all-weld metal as per AWS (Shielding gas: CO₂)

	0.2%OS (MPa)	TS (MPa)	EI (%)	IV (J)
Example	450	590	32	0°C: 33
Guaranty	-	≥550	≥30	-

Recommended welding parameters

	Dia.	1.2mm	1.6mm
F, HF	130~270A	190~340A	
H	150~220A	220~270A	

Packages

Dia. (mm)	Type	Weight (kg)
1.2	Spool	12.5
1.6	Spool	12.5

DW-309L**PREMIARC™****Rutile type flux cored wire for dissimilar metals**

Classification: ASME / AWS A5.22 E309LT0-1/4
EN ISO 17633-A-T 23 12 L R C/M 3
JIS Z3323 YF309LC

Features : •Suitable for dissimilar-metal joint and underlaying on ferritic steels for overlaying stainless steel weld metals

•Lower carbon content than **DW-309**

Shielding gas: CO₂ or Ar-CO₂ mixture

Polarity: DC-EP

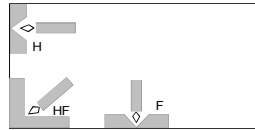
Welding positions:**Chemical composition of all-weld metal (%) as per AWS (Shielding gas: CO₂)**

	C	Si	Mn	P	S	Ni	Cr	Mo	Cu
Example	0.028	0.61	1.24	0.019	0.010	12.58	24.17	0.05	0.03
Guaranty	≤0.040	≤1.00	0.50~ 2.50	≤0.040	≤0.030	12.00~ 14.00	22.00~ 25.00	≤0.50	≤0.50

Mechanical properties of all-weld metal as per AWS (Shielding gas: CO₂)

	0.2%OS (MPa)	TS (MPa)	EI (%)
Example	450	580	33
Guaranty	-	≥520	≥30

Recommended welding parameters

	Dia.	0.9mm	1.2mm	1.6mm
F, HF	80~150A	130~270A	190~340A	
H	90~130A	150~220A	220~270A	

Approvals

AB	LR	NV	BV	NK	Others
MG	SS/CMn S (Chem.)	309LMS	MG	KW309LG(C) (base on KW309)	GL, CWB

Packages

Dia. (mm)	Type	Weight (kg)
0.9	Spool	5, 12.5
1.2	Spool	12.5
1.6	Spool	12.5

DW-309LP**PREMIARC™****Rutile type flux cored wire for dissimilar metals**

Classification: ASME / AWS A5.22 E309LT1-1/4
EN ISO 17633-A-T 23 12 L P C/M 1
JIS Z3323 YF309LC

Features : •Suitable for dissimilar-metal joint and underlaying on ferritic steels for overlaying stainless steel weld metals

•Lower carbon content than **DW-309**

Shielding gas: CO₂ or Ar-CO₂ mixture

Polarity: DC-EP

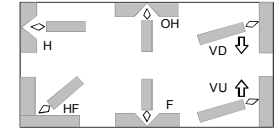
Welding positions:**Chemical composition of all-weld metal (%) as per AWS (Shielding gas: CO₂)**

	C	Si	Mn	P	S	Ni	Cr	Mo	Cu
Example	0.027	0.56	1.21	0.023	0.009	12.45	23.55	0.04	0.06
Guaranty	≤0.040	≤1.00	0.50~ 2.50	≤0.040	≤0.030	12.00~ 14.00	22.00~ 25.00	≤0.50	≤0.50

Mechanical properties of all-weld metal as per AWS (Shielding gas: CO₂)

	0.2%OS (MPa)	TS (MPa)	EI (%)
Example	430	570	38
Guaranty	-	≥520	≥30

Recommended welding parameters

	Dia.	1.2mm	Dia.	1.2mm
F, HF	130~270A	OH	150~200A	
H	150~220A	VD	150~200A	
VU	130~220A			

VD position: multi-pass welding is not recommended.

Approvals

LR	NV	BV	NK	Others
SS/CMn MS (Chem.,Cryo)	309L	309L	KW309LG(C)	CWB

Packages

Dia. (mm)	Type	Weight (kg)
1.2	Spool	12.5

DW-309MoL**PREMIARC™****Rutile type flux cored wire for dissimilar metals**

Classification: ASME / AWS A5.22 E309LMoT0-1/4
EN ISO 17633-A-T 23 12 2 L R C/M 3
JIS Z3323 YF309MoLc

Features : •Suitable for dissimilar-metal joint and underlaying on ferritic steels for overlaying stainless steel weld metals

Shielding gas: CO₂ or Ar-CO₂ mixture

Polarity: DC-EP

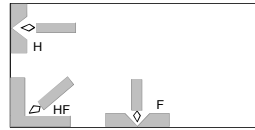
Welding positions:**Chemical composition of all-weld metal (%) as per AWS (Shielding gas: CO₂)**

	C	Si	Mn	P	S	Ni	Cr	Mo	Cu
Example	0.027	0.61	1.18	0.019	0.009	12.60	23.20	2.37	0.03
Guaranty	≤0.040	≤1.00	0.50~ 2.50	≤0.040	≤0.030	12.00~ 14.00	22.00~ 25.00	2.00~ 3.00	≤0.50

Mechanical properties of all-weld metal as per AWS (Shielding gas: CO₂)

	0.2%OS (MPa)	TS (MPa)	EI (%)
Example	540	720	30
Guaranty	-	≥520	≥25

Recommended welding parameters

	0.9mm	1.2mm	1.6mm
Dia.	0.9mm	1.2mm	1.6mm
F, HF	80~150A	130~270A	190~340A
H	90~130A	150~220A	220~270A

Approvals

AB	LR	NV	BV	NK	Others
MG	SS/CMn S (Chem.)	309MoLMS	MG	MG	TÜV

Packages

Dia. (mm)	Type	Weight (kg)
0.9	Spool	5, 12.5
1.2	Spool	12.5
1.6	Spool	12.5

DW-309MoLP**PREMIARC™****Rutile type flux cored wire for dissimilar metals**

Classification: ASME / AWS A5.22 E309LMoT1-1/4
EN ISO 17633-A-T 23 12 2 L R C/M 1
JIS Z3323 YF309MoLc

Features : •Suitable for dissimilar-metal joint and underlaying on ferritic steels for overlaying stainless steel weld metals

Shielding gas: CO₂ or Ar-CO₂ mixture

Polarity: DC-EP

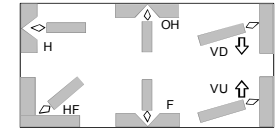
Welding positions:**Chemical composition of all-weld metal (%) as per AWS (Shielding gas: CO₂)**

	C	Si	Mn	P	S	Ni	Cr	Mo	Cu
Example	0.025	0.62	0.81	0.020	0.010	12.44	22.60	2.21	0.05
Guaranty	≤0.040	≤1.00	0.50~ 2.50	≤0.040	≤0.030	12.00~ 14.00	22.00~ 25.00	2.00~ 3.00	≤0.50

Mechanical properties of all-weld metal as per AWS (Shielding gas: CO₂)

	0.2%OS (MPa)	TS (MPa)	EI (%)
Example	540	699	30
Guaranty	-	≥520	≥25

Recommended welding parameters

	1.2mm	Dia.	1.2mm
Dia.	1.2mm	Dia.	1.2mm
F, HF	130~270A	OH	150~200A
H	150~220A	VD	150~200A
VU	130~220A		

VD position: multi-pass welding is not recommended

Packages

Dia. (mm)	Type	Weight (kg)
1.2	Spool	12.5

DW-316**PREMIARC™**

Rutile type flux cored wire for 18%Cr-12%Ni-2%Mo stainless steel

Classification: ASME / AWS A5.22 E316T0-1/4
EN ISO 17633-A-T Z 19 12 2 R C/M 3
JIS Z3323 YF316C

Features : •Applicable for 316 type steel
•Suitable for flat and horizontal fillet welding

Shielding gas: CO₂ or Ar-CO₂ mixture

Polarity: DC-EP

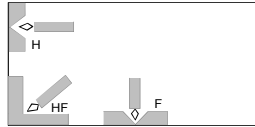
Welding positions:**Chemical composition of all-weld metal (%) as per AWS (Shielding gas: CO₂)**

	C	Si	Mn	P	S	Ni	Cr	Mo	Cu
Example	0.043	0.59	1.50	0.021	0.010	12.04	19.30	2.31	0.03
Guaranty	≤0.080	≤1.00	0.50~ 2.50	≤0.040	≤0.030	11.00~ 14.00	17.00~ 20.00	2.00~ 3.00	≤0.50

Mechanical properties of all-weld metal as per AWS (Shielding gas: CO₂)

	0.2%OS (MPa)	TS (MPa)	EI (%)	IV (J)
Example	390	555	40	0°C: 42
Guaranty	-	≥550	≥30	-

Recommended welding parameters

	0.9mm	1.2mm	1.6mm
Dia.	0.9mm	1.2mm	1.6mm
F, HF	80~150A	130~270A	190~340A
H	90~130A	150~220A	220~270A

Packages

Dia. (mm)	Type	Weight (kg)
1.2	Spool	12.5
1.6	Spool	12.5

DW-316L**PREMIARC™**

Rutile type flux cored wire for low carbon 18%Cr-12%Ni-2%Mo stainless steel

Classification: ASME / AWS A5.22 E316LT0-1/4
EN ISO 17633-A-T Z 19 12 3 R C/M 3
JIS Z3323 YF316LC

Features : •Applicable for 316L type steel
•Suitable for flat and horizontal fillet welding
•Lower carbon content than **DW-316**

Shielding gas: CO₂ or Ar-CO₂ mixture

Polarity: DC-EP

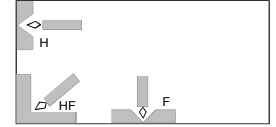
Welding positions:**Chemical composition of all-weld metal (%) as per AWS (Shielding gas: CO₂)**

	C	Si	Mn	P	S	Ni	Cr	Mo	Cu
Example	0.026	0.59	1.43	0.020	0.010	12.02	18.95	2.54	0.06
Guaranty	≤0.040	≤1.00	0.50~ 2.50	≤0.040	≤0.030	11.00~ 14.00	17.00~ 20.00	2.00~ 3.00	≤0.50

Mechanical properties of all-weld metal as per AWS (Shielding gas: CO₂)

	0.2%OS (MPa)	TS (MPa)	EI (%)	IV (J)
Example	380	540	41	0°C: 44
Guaranty	-	≥485	≥30	-

Recommended welding parameters

	0.9mm	1.2mm	1.6mm
Dia.	0.9mm	1.2mm	1.6mm
F, HF	80~150A	130~270A	190~340A
H	90~130A	150~220A	220~270A

Approvals

AB	LR	NV	BV	NK	Others
MG	316L S (Chem.)	316LMS	MG	KW316LG(C)	GL, CWB, TÜV

Packages

Dia. (mm)	Type	Weight (kg)
0.9	Spool	5, 12.5
1.2	Spool	12.5
1.6	Spool	12.5

DW-316LP



Rutile type flux cored wire for low carbon 18%Cr-12%Ni-2%Mo stainless steel

Classification: ASME / AWS A5.22 E316LT1-1/4
EN ISO 17633-A-T 19 12 3 L P C/M 1
JIS Z3323 YF316LC

Features : •Applicable for 316 and 316L type steel
•Suitable for butt and fillet welding in all positions including vertical downward
•Lower carbon content than **DW-316**

Shielding gas : CO₂ or Ar-CO₂ mixture
Polarity: DC-EP

Welding positions:

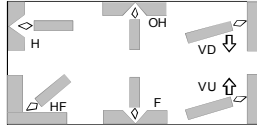

Chemical composition of all-weld metal (%) as per AWS (Shielding gas: CO₂)

	C	Si	Mn	P	S	Ni	Cr	Mo
Example	0.028	0.60	1.50	0.021	0.008	12.65	18.35	2.68
Guaranty	≤0.040	≤1.00	0.50~ 2.50	≤0.040	≤0.030	11.00~ 14.00	17.00~ 20.00	2.00~ 3.00

Mechanical properties of all-weld metal as per AWS (Shielding gas: CO₂)

	0.2%OS (MPa)	TS (MPa)	El (%)	IV (J)
Example	370	540	43	0°C: 54
Guaranty	-	≥485	≥30	-

Recommended welding parameters

	Dia.	1.2mm	Dia.	1.2mm
F, HF	130~270A	OH	150~200A	
H	150~220A	VD	150~200A	
VU	130~220A			

VD position: multi-pass welding is not recommendable.

Approvals

NV	BV	NK	Others
316L	316L	KW316LG(C)	CWB

Packages

Dia. (mm)	Type	Weight (kg)
1.2	Spool	12.5

DW-329A



Rutile type flux cored wire for duplex stainless steel

Classification: ASME / AWS A5.22 E2209T0-1/4
EN ISO 17633-A-T 22 9 3 N L R C/M 3

Features : •Applied for SUS329J3L and ASTM S31803 steel
•Suitable for flat and horizontal fillet welding

Shielding gas: CO₂ or Ar-CO₂ mixture
Polarity: DC-EP

Welding positions:

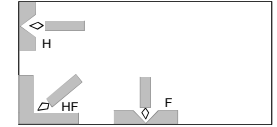

Chemical composition of all-weld metal (%) as per AWS (Shielding gas: CO₂)

	C	Si	Mn	P	S	Ni	Cr	Mo	N	Cu
Example	0.030	0.58	1.12	0.018	0.008	9.34	22.91	3.08	0.12	0.01
Guaranty	≤0.040	≤1.00	0.50~ 2.00	≤0.040	≤0.030	8.00~ 10.00	22.00~ 24.00	2.50~ 4.00	0.08~ 0.20	≤0.50

Mechanical properties of all-weld metal as per AWS (Shielding gas: CO₂)

	0.2%OS (MPa)	TS (MPa)	El (%)	IV (J)
Example	610	810	29	-20°C: 42
Guaranty	-	≥690	≥20	-

Recommended welding parameters

	Dia.	1.2mm	1.6mm
F, HF	130~250A	200~300A	
H	150~220A	220~250A	

Approvals

Others
TÜV

Packages

Dia. (mm)	Type	Weight (kg)
1.2	Spool	12.5
1.6	Spool	12.5

DW-329AP**PREMIARC™****Rutile type flux cored wire for duplex stainless steel****Classification:** ASME / AWS A5.22 E2209T1-1/4

EN ISO 17633-A-T 22 9 3 N L P C/M 1

Features : •Applicable for SUS329J3L and ASTM S31803 steel

•Suitable for butt and fillet welding in all positions

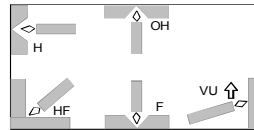
Shielding gas: CO₂ or Ar-CO₂ mixture**Polarity:** DC-EP**Welding positions:****Chemical composition of all-weld metal (%) as per AWS (Shielding gas: CO₂)**

	C	Si	Mn	P	S	Ni	Cr	Mo	N	Cu
Example	0.027	0.58	0.78	0.019	0.008	9.42	23.34	3.42	0.14	0.02
Guaranty	≤0.040	≤1.00	0.50~ 2.00	≤0.025	≤0.020	8.00~ 10.00	22.00~ 24.00	2.50~ 4.00	0.08~ 0.20	≤0.50

Mechanical properties of all-weld metal as per AWS (Shielding gas: CO₂)

	0.2%OS (MPa)	TS (MPa)	EI (%)	IV (J)
Example	620	830	29	-20°C: 45
Guaranty	≥500	≥700	≥20	-

Recommended welding parameters

Dia.	1.2mm
F, HF	130~250A
H	150~220A
VU	130~220A
OH	160~190A

Approvals

Others
CWB

Packages

Dia. (mm)	Type	Weight (kg)
1.2	Spool	12.5

Trade designation	ASME AWS Class.	Type of cored flux	SG	Pol.	Features	WP	Chemical			composition of all-weld metal (%)					Mechanical properties of all-weld metal						
							C	Si	Mn	P	S	Ni	Cr	Others	0.2%OS (MPa)	TS (MPa)	EI (%)	IV (J)	SG		
DW-308H	A5.22 E308H T1-1/4	Rutile	CO ₂	DC-EP	•Suitable for 18%Cr-8%Ni stainless steel for high temperature service	F	Ex	0.060	0.42	1.50	0.020	0.007	9.62	18.68	Bi: tr.	Ex	370	560	48	0°C: 71	CO ₂
						H									Gt					0.040~0.080	
DW-308LH	A5.22 E308L T1-1/4	Rutile	CO ₂	DC-EP	•Suitable for 18%Cr-8%Ni stainless steel with high temperature heat treatment such as solution treatment	F	E	0.026	0.41	1.35	0.021	0.005	10.20	18.70		Bi: tr.	Ex	360	540	52	0°C: 76
						H									Gt	≤0.040					≤1.00
DW-309LH	A5.22 E309L T1-1/4	Rutile	CO ₂	DC-EP	•Suitable for dissimilar metal joint and underlaying on ferritic steels for overlaying stainless steel weld metals	F	Ex	0.029	0.41	1.25	0.021	0.008	12.61	23.79		Bi: tr.	Ex	380	590	36	-
						H									Gt	≤0.040					≤1.00

Note: Welding tests are as per AWS. Ex: Example, Gt: Guaranty

■ Approvals

DW-308H CWB

■ Diameter (mm)

DW-308H	1.2, 1.6
DW-308LH	1.2, 1.6
DW-309LH	1.2, 1.6

Trade designation	ASME AWS Class.	Type of cored flux	SG	Pol.	Features	WP	Chemical			composition of all-weld metal (%)					Mechanical properties of all-weld metal						
							C	Si	Mn	P	S	Ni	Cr	Others	0.2%OS (MPa)	TS (MPa)	EI (%)	IV (J)	SG		
DW-316H	A5.22 E316 T1-1/4	Rutile	CO ₂ Ar-CO ₂	DC-EP	▪Suitable for 18%Cr-12%Ni-2%Mo stainless steel for high temperature service	F HF H VU OH	Ex	0.050	0.38	1.10	0.019	0.006	11.60	18.75	Mo: 2.40 Bi: tr.	Ex	390	570	41	0°C: 68	CO ₂
							Gt	≤0.08	≤1.00	0.50~ 2.50	≤0.040	≤0.030	11.00~ 14.00	17.00~ 20.00	Mo: 2.00~ 3.00 Bi ≤0.001	Gt	-	≥550	≥30	-	
DW-316LH	A5.22 E316L T1-1/4	Rutile	CO ₂ Ar-CO ₂	DC-EP	▪Suitable for 18%Cr-12%Ni-2%Mo stainless steel with high temperature heat treatment such as solution treatment	F HF H VU OH	Ex	0.023	0.45	1.08	0.020	0.007	11.94	18.47	Mo: 2.45 Bi: tr.	Ex	390	540	44	0°C: 66	CO ₂
							Gt	≤0.040	≤1.00	0.50~ 2.50	≤0.040	≤0.030	11.00~ 14.00	17.00~ 20.00	Mo: 2.00~ 3.00 Bi ≤0.001	Gt	-	≥490	≥35	-	
DW-347H	A5.22 E347 T1-1/4	Rutile	CO ₂ Ar-CO ₂	DC-EP	▪Suitable for 18%Cr-8%Ni-Nb and 18%Cr-8%Ni-Ti stainless steel for high temperature service	F HF H VU OH	Ex	0.027	0.38	1.18	0.018	0.008	10.20	18.87	Nb: 0.57 Bi: tr.	Ex	420	600	43	0°C: 80	CO ₂
							Gt	≤0.08	≤1.00	0.50~ 2.50	≤0.040	≤0.030	9.00~ 11.00	18.00~ 21.00	Nb: 8xC~ 1.00 Bi ≤0.001	Gt	-	≥550	≥30	-	

Note: Welding tests are as per AWS. Ex: Example, Gt: Guaranty

■ Diameter (mm)

DW-316H	1.2, 1.6
DW-316LH	1.2, 1.6
DW-347H	1.2, 1.6

Trade designation	ASME AWS Class.	Type of cored flux	SG	Pol.	Features	WP	Chemical		composition of all-weld metal (%)					Mechanical properties of all-weld metal						
							C	Si	Mn	P	S	Ni	Cr	0.2%OS (MPa)	TS (MPa)	EI (%)	IV (J)	SG		
DW-308LT	A5.22 E308L T0-1/4	Rutile	CO ₂ Ar-CO ₂	DC-EP	▪Suitable for 18%Cr-8%Ni stainless steel for low temperature service	F HF	Ex	0.026	0.45	2.37	0.023	0.009	10.30	18.60	Ex	380	530	51	-196°C: 39	CO ₂
							Gt	≤0.040	≤1.00	0.50~2.50	≤0.040	≤0.030	9.00~11.00	18.00~21.00	Gt	-	≥520	≥35	-196°C: ≥27	
DW-310	A5.22 E310 T0-1/4	Rutile	CO ₂ Ar-CO ₂	DC-EP	▪Suitable for 25%Cr-20%Ni stainless steel	F HF	Ex	0.18	0.58	2.10	0.016	0.005	20.36	25.50	Ex	420	620	33	0°C: 68	CO ₂
							Gt	≤0.20	≤1.00	0.50~2.50	≤0.040	≤0.030	20.00~22.00	25.00~28.00	Gt	-	≥550	≥30	-	
DW-312	A5.22 E312 T0-1	Rutile	CO ₂	DC-EP	▪Suitable for dissimilar-metal joint and underlaying on ferritic steels for overlaying stainless steel weld metals	F HF	Ex	0.11	0.53	1.62	0.019	0.009	10.23	28.44	Ex	600	720	23	-	CO ₂
							Gt	≤0.15	≤1.00	0.50~2.50	≤0.040	≤0.030	8.00~10.50	28.00~32.00	Gt	-	≥660	≥22	-	

Note: Welding tests are as per AWS. Ex: Example, Gt: Guaranty

■ Approvals

DW-308LT	LR,NV,NK
DW-310	CWB
DW-312	CWB

■ Diameter (mm)

DW-308LT	1.2
DW-310	1.2
DW-312	1.2

Trade designation	ASME AWS Class.	Type of cored flux	SG	Pol.	Features	WP	Chemical		composition of all-weld metal (%)							Mechanical properties of all-weld metal					
							C	Si	Mn	P	S	Ni	Cr	Others	0.2%OS (MPa)	TS (MPa)	EI (%)	IV (J)	SG		
DW-316LT	A5.22 E316L T1-1/4	Rutile	CO ₂ Ar-CO ₂	DC-EP	•Suitable for 18%Cr-12%Ni-2%Mo stainless steel for low temperature service	F HF H VU OH	Ex	0.027	0.41	1.20	0.021	0.008	12.39	17.62	2.21	Ex	405	537	44	-196°C: 40	CO ₂
								Gt	≤0.040	≤1.00	0.50~2.50	≤0.040	≤0.030	11.00~14.00	17.00~20.00	Mo: 2.00~3.00	Gt	-	≥490	≥35	
DW-317L	A5.22 E317L T0-1/4	Rutile	CO ₂ Ar-CO ₂	DC-EP	•Suitable for 18%Cr-12%Ni-2%Mo-N and 19%Cr-13%Ni-3%Mo stainless steel	F HF	Ex	0.025	0.59	1.10	0.020	0.010	13.01	19.81	Mo: 3.35	Ex	380	590	37	0°C: 43	CO ₂
								Gt	≤0.040	≤1.00	0.50~2.50	≤0.040	≤0.030	12.00~14.00	18.00~21.00	Mo: 3.00~4.00	Gt	-	≥520	≥20	
DW-347	A5.22 E347 T0-1/4	Rutile	CO ₂ Ar-CO ₂	DC-EP	•Suitable for 18%Cr-8%Ni-Nb and 18%Cr-8%Ni-Ti stainless steel	F HF	Ex	0.026	0.41	1.48	0.018	0.008	10.46	18.66	Nb: 0.58	Ex	390	550	43	0°C: 49	CO ₂
								Gt	≤0.08	≤1.00	0.50~2.50	≤0.040	≤0.030	9.00~11.00	18.00~21.00	Nb: 8xC~1.00	Gt	-	≥520	≥30	
DW-2101	-	Rutile	CO ₂ Ar-CO ₂	DC-EP	•Suitable for lean duplex stainless steel of S32101	F HF H VU	Ex	0.025	0.64	1.41	0.017	0.003	8.3	24.6	N: 0.13	Ex	590	754	29	20°C: 50	Ar-CO ₂

Note: Welding tests are as per AWS. Ex: Example, Gt: Guaranty

■ Approvals

DW-316LT	AB, LR, BV, KR
DW-317L	CWB
DW-347	CWB

■ Diameter (mm)

DW-316LT	1.2
DW-317L	1.2, 1.6
DW-347	1.2, 1.6
DW-2101	1.2

Trade designation	ASME AWS Class.	Type of cored flux	SG	Pol.	Features	WP	Chemical		composition of all-weld metal (%)						Mechanical properties of all-weld metal						
							C	Si	Mn	P	S	Ni	Cr	Others	0.2%OS (MPa)	TS (MPa)	EI (%)	IV (J)	PWHT (°C/h)		
MX-A410NM	-	Metal	Ar-CO ₂	DC-EP	<ul style="list-style-type: none"> Suitable for 13%Cr-Ni type stainless steel Preheat (100°C) must be done depending on thickness of base metal 	F HF	Ex	0.020	0.57	0.45	0.019	0.006	4.25	12.25	Mo: 0.46	Ex	870	920	20	0°C: 64	600 x1 AC
							Gt	≤0.060	≤1.00	≤1.00	≤0.040	≤0.030	4.00~5.00	11.00~12.50	Mo: 0.40~0.70	Gt	≥540	≥760	≥15	-	595~620 x1
MX-A135N	-	Metal	Ar-CO ₂	DC-EP	<ul style="list-style-type: none"> Suitable for 13%Cr-Ni type stainless steel Preheat (100°C) must be done depending on thickness of base metal 	F HF	Ex	0.015	0.58	0.44	0.018	0.006	5.02	12.88	0.02	Ex	810	880	21	0°C: 55	590 x10 FC
							Gt	≤0.040	≤1.00	≤1.00	≤0.030	≤0.025	4.60~5.40	11.50~13.50	Mo ≤0.50	Gt	≥540	≥740	≥17	-	580~600 x10
MX-A430M	-	Metal	Ar-CO ₂	DC-EP	<ul style="list-style-type: none"> Suitable for 17%Cr and 13% Cr type stainless steel Applied for thin plate in short circuiting welding 	F HF	Ex	0.047	0.40	0.14	0.008	0.017	0.08	17.0	Nb: 0.75	Ex	390	540	26	-	AW

Note: Welding tests are as per AWS. Ex: Example, Gt: Guaranty

Diameter (mm)

MX-A410NM	1.2, 1.6
MX-A430M	1.2, 1.4
MX-A135N	1.2, 1.4, 1.6

Trade designation	ASME AWS Class.	SG	Pol.	Features	WP	Chemical composition of wire (%)										Mechanical properties of all-weld metal				
						C	Si	Mn	P	S	Ni	Cr	Mo	Cu	0.2%OS (MPa)	TS (MPa)	EI (%)	IV (J)		
MG-S308	A5.9 ER308	98%Ar-2%O ₂	DC-EP	•Suitable for 18%Cr-8%Ni stainless steel	F	Ex	0.04	0.43	1.70	0.022	0.003	9.68	19.89	0.08	0.11	Ex	410	600	40	-196°C: 49
					H	Gt	≤0.08	0.30~0.65	1.00~2.50	≤0.030	≤0.030	9.00~11.00	19.50~22.00	≤0.75	≤0.75					
MG-S308LS	A5.9 ER308LSi	98%Ar-2%O ₂	DC-EP	•Suitable for low carbon 18%Cr-8%Ni stainless steel	F		Ex	0.017	0.79	1.91	0.021	0.001	9.86	19.78	0.04	0.04	Ex	400	580	42
					H	Gt	≤0.030	0.65~1.00	1.00~2.50	≤0.030	≤0.030	9.00~11.00	19.50~22.00	≤0.75	≤0.75					
MG-S309	A5.9 ER309	98%Ar-2%O ₂	DC-EP	•Suitable for dissimilar-metal joint and underlaying on ferritic steels for overlaying stainless steel weld metals	F		Ex	0.05	0.46	1.97	0.021	0.002	13.66	23.29	0.03	0.03	Ex	430	610	39
					H	Gt	≤0.12	0.30~0.65	1.00~2.50	≤0.030	≤0.030	12.00~14.00	23.00~25.00	≤0.75	≤0.75					
MG-S309LS	A5.9 ER309LSi	98%Ar-2%O ₂	DC-EP	•Suitable for dissimilar-metal joint and underlaying on ferritic steels for overlaying stainless steel weld metals	F		Ex	0.020	0.84	1.85	0.021	0.003	13.28	23.57	0.03	0.03	Ex	410	570	40
					H	Gt	≤0.030	0.65~1.00	1.00~2.50	≤0.030	≤0.030	12.00~14.00	23.00~25.00	≤0.75	≤0.75					
MG-S316LS	A5.9 ER316LSi	98%Ar-2%O ₂	DC-EP	•Suitable for low carbon 18%Cr-12%Ni-2%Mo stainless steel	F		Ex	0.017	0.79	1.97	0.019	0.002	12.25	19.35	2.36	0.12	Ex	380	550	41
					H	Gt	≤0.030	0.65~1.00	1.00~2.50	≤0.030	≤0.030	11.00~14.00	18.00~20.00	2.00~3.00	≤0.75					

Note; Welding tests are as per AWS. Ex: Example, Gt: Guaranty

Diameter (mm)

MG-S308	1.2
MG-S308LS	0.8, 1.0, 1.2
MG-S309	1.2, 1.6
MG-S309LS	1.0, 1.2
MG-S316LS	1.2

TG-X308L



Flux cored filler rod for low carbon 18%Cr-8%Ni stainless steel

Classification: ASME / AWS A5.22 R308LT1-5
Features : •Applicable for 304 and 304L type steels
 •Suitable for root pass in one-side TIG welding without back shielding
Shielding gas: Ar
Polarity: DC-EN

Welding positions:

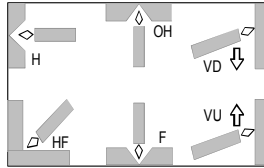

Chemical composition of all-weld metal (%) as per AWS

	C	Si	Mn	P	S	Ni	Cr	Mo	Cu
Example	0.018	0.80	1.66	0.023	0.005	10.31	19.62	0.02	0.03
Guaranty	≤0.03	≤1.20	0.50~2.50	≤0.040	≤0.030	9.00~11.00	18.00~21.00	≤0.50	≤0.50

Mechanical properties of all-weld metal as per AWS

	0.2%OS (MPa)	TS (MPa)	EI (%)	IV (J)
Example	450	620	47	-196°C: 60
Guaranty	-	≥520	≥35	-

Recommended welding parameters

Plate thickness	Welding current
3~5mm	80~90A
6~9mm	90~105A
≥10mm	90~110A

Packages

Dia. (mm)	Type	Weight (kg)	Length (mm)	Weight per piece (g)
2.2	tube	5	1,000	25

TG-X309L



Flux cored filler rod for dissimilar metals

Classification: ASME / AWS A5.22 R309LT1-5
Features : •Suitable for root pass in one-side TIG welding without back shielding
 •Applicable for dissimilar-metal joint of austenitic stainless steels and ferritic steels
Shielding gas: Ar
Polarity: DC-EN

Welding positions:

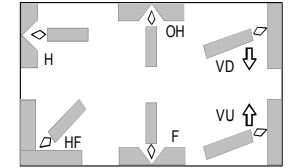

Chemical composition of all-weld metal (%) as per AWS

	C	Si	Mn	P	S	Ni	Cr	Mo	Cu
Example	0.017	0.81	1.52	0.022	0.006	12.62	24.26	0.02	0.03
Guaranty	≤0.03	≤1.20	0.50~2.50	≤0.040	≤0.030	12.00~14.00	22.00~25.00	≤0.50	≤0.50

Mechanical properties of all-weld metal as per AWS

	0.2%OS (MPa)	TS (MPa)	EI (%)
Example	530	680	32
Guaranty	-	≥520	≥30

Recommended welding parameters

Plate thickness	Welding current
3~5mm	80~90A
6~9mm	90~105A
≥10mm	90~110A

Packages

Dia. (mm)	Type	Weight (kg)	Length (mm)	Weight per piece (g)
2.2	tube	5	1,000	25

TG-X316L



Flux cored filler rod for low carbon 18%Cr-12%Ni-2%Mo stainless steel

Classification: ASME / AWS A5.22 R316LT1-5
Features : •Applicable for 316 and 316L type steels
 •Suitable for root pass in one-side TIG welding without back shielding
Shielding gas: Ar
Polarity: DC-EN

Welding positions:

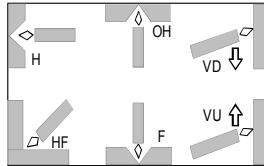

Chemical composition of all-weld metal (%) as per AWS

	C	Si	Mn	P	S	Ni	Cr	Mo	Cu
Example	0.016	0.87	1.55	0.023	0.004	12.47	18.89	2.32	0.03
Guaranty	≤0.03	≤1.20	0.50~2.50	≤0.040	≤0.030	11.00~14.00	17.00~20.00	2.00~3.00	≤0.50

Mechanical properties of all-weld metal as per AWS

	0.2%OS (MPa)	TS (MPa)	EI (%)	IV (J)
Example	440	600	38	0°C: 110
Guaranty	-	≥485	≥30	-

Recommended welding parameters

Plate thickness Welding current

3~5mm	80~90A
6~9mm	90~105A
≥10mm	90~110A

Packages

Dia. (mm)	Type	Weight (kg)	Length (mm)	Weight per piece (g)
2.2	tube	5	1,000	25

TG-X347



Flux cored filler rod for 18%Cr-8%Ni-Nb and 18%Cr-8Ni-Ti stainless steel

Classification: ASME / AWS A5.22 R347T1-5
Features : •Applicable for 347 and 321 type steels
 •Suitable for root pass in one-side TIG welding without back shielding
Shielding gas: Ar
Polarity: DC-EN

Welding positions:

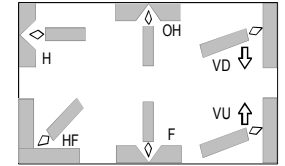

Chemical composition of all-weld metal (%) as per AWS

	C	Si	Mn	P	S
Example	0.020	0.80	1.60	0.021	0.004
Guaranty	≤0.08	≤1.20	0.50~2.50	≤0.040	≤0.030
	Ni	Cr	Nb+Ta	Mo	Cu
Example	10.21	19.09	0.66	0.02	0.03
Guaranty	9.00~11.00	18.00~21.00	8xC%~1.0	≤0.50	≤0.50

Mechanical properties of all-weld metal as per AWS

	0.2%OS (MPa)	TS (MPa)	EI (%)	IV (J)
Example	460	630	48	0°C: 130
Guaranty	-	≥520	≥30	-

Recommended welding parameters

Plate thickness	Welding current
3~5mm	80~90A
6~9mm	90~105A
≥10mm	90~110A

Packages

Dia. (mm)	Type	Weight (kg)	Length (mm)	Weight per piece (g)
2.2	tube	5	1,000	25

Trade designation	ASME AWS Class.	SG	Pol.	Features	Chemical composition of rod and wire (%)										Mechanical properties of all-weld metal				
					C	Si	Mn	P	S	Ni	Cr	Mo	Cu	0.2%OS (MPa)	TS (MPa)	EL (%)	IV (J)		
TG-S308	A5.9 ER308	Ar	DC-EN	•Suitable for 18%Cr-8%Ni stainless steel	Ex	0.05	0.46	1.89	0.024	0.001	9.69	20.00	0.05	0.07	Ex	410	580	42	-196°C: 39
					Gt	≤0.08	0.30~0.65	1.00~2.50	≤0.030	≤0.030	9.00~11.00	19.50~22.00	≤0.75	≤0.75					
TG-S308L	A5.9 ER308L	Ar	DC-EN	•Suitable for low carbon 18%Cr-8%Ni stainless steel	Ex	0.013	0.43	1.86	0.023	0.002	9.95	19.85	0.05	0.07	Ex	420	590	45	-196°C: 78
					Gt	≤0.030	0.30~0.65	1.00~2.50	≤0.030	≤0.030	9.00~11.00	19.50~22.00	≤0.75	≤0.75					
TG-S309	A5.9 ER309	Ar	DC-EN	•Suitable for dissimilar-metal joint and underlaying on ferritic steels for overlaying stainless steel weld metals	Ex	0.05	0.45	1.85	0.025	0.001	13.58	23.37	0.03	0.07	Ex	410	580	39	0°C: 150
					Gt	≤0.12	0.30~0.65	1.00~2.50	≤0.030	≤0.030	12.00~14.00	23.00~25.00	≤0.75	≤0.75					
TG-S309L	A5.9 ER309L	Ar	DC-EN	•Suitable for dissimilar-metal joint and underlaying on ferritic steels for overlaying stainless steel weld metals	Ex	0.016	0.41	1.84	0.019	0.002	13.68	23.28	0.03	0.04	Ex	410	570	38	0°C: 110
					Gt	≤0.030	0.30~0.65	1.00~2.50	≤0.030	≤0.030	12.00~14.00	23.00~25.00	≤0.75	≤0.75					
TG-S309MoL	A5.9 ER309LMo	Ar	DC-EN	•Suitable for dissimilar-metal joint and underlaying on ferritic steels for overlaying stainless steel weld metals	Ex	0.016	0.43	1.76	0.016	0.005	13.54	23.35	2.19	0.05	Ex	440	590	36	-
					Gt	≤0.030	0.30~0.65	1.00~2.50	≤0.030	≤0.030	12.00~14.00	23.00~25.00	2.00~3.00	≤0.75					
TG-S316	A5.9 ER316	Ar	DC-EN	•Suitable for 18%Cr-12%Ni-2%Mo stainless steel	Ex	0.04	0.42	1.71	0.026	0.001	12.25	19.39	2.15	0.11	Ex	390	570	42	-196°C: 29
					Gt	≤0.08	0.30~0.65	1.00~2.50	≤0.030	≤0.030	11.00~14.00	18.00~20.00	2.00~3.00	≤0.75					
TG-S316L	A5.9 ER316L	Ar	DC-EN	•Suitable for low carbon 18%Cr-12%Ni-2%Mo stainless steel	Ex	0.014	0.41	1.74	0.023	0.002	12.29	19.22	2.19	0.11	Ex	390	550	43	-196°C: 49
					Gt	≤0.030	0.30~0.65	1.00~2.50	≤0.030	≤0.030	11.00~14.00	18.00~20.00	2.00~3.00	≤0.75					

Note: Welding tests are as per AWS. Ex: Example, Gt: Guaranty

■ Approvals

TG-S308	AB, NV, NK	TG-S309	NV, NK, GL
TG-S308L	AB, LR, NV, BV, NK, GL, CCS	TG-S316L	AB, LR, NV, BV, NK, GL, CCS

■ Diameter (mm)

TG-S308	1.0, 1.2, 1.6, 2.0, 2.4, 3.2	TG-S309MoL	1.2, 1.6, 2.0, 2.4, 3.2
TG-S308L	1.0, 1.2, 1.6, 2.0, 2.4, 3.2	TG-S316	1.0, 1.2, 1.6, 2.0, 2.4, 3.2
TG-S309	1.0, 1.2, 1.6, 2.0, 2.4, 3.2	TG-S316L	1.0, 1.2, 1.6, 2.0, 2.4, 3.2
TG-S309L	1.0, 1.2, 1.6, 2.0, 2.4, 3.2		

Trade designation	ASME AWS Class.	SG	Pol.	Features	Chemical composition of rod and wire (%)											Mechanical properties of all-weld metal				
					C	Si	Mn	P	S	Ni	Cr	Mo	Cu	Nb	0.2%OS (MPa)	TS (MPa)	EL (%)	IV (J)		
TG-S317L	A5.9 ER317L	Ar	DC-EN	•Suitable for low carbon 18%Cr-12%Ni-2%Mo-N and low carbon 19%Cr-13%Ni-3%Mo stainless steel	Ex	0.010	0.38	1.80	0.007	0.001	13.11	18.76	3.49	0.03	-	Ex	410	570	39	0°C: 98
					Gt	≤0.030	0.30~0.65	1.00~2.50	≤0.030	≤0.030	13.00~15.00	18.50~20.50	3.00~4.00	≤0.75	-					
TG-S347	A5.9 ER347	Ar	DC-EN	•Suitable for 18%Cr-8%Ni-Nb and 18%Cr-8%Ni-Ti stainless steel	Ex	0.05	0.43	2.29	0.020	0.003	9.85	19.51	0.06	0.07	0.66	Ex	460	630	40	0°C: 88
					Gt	≤0.08	0.30~0.65	1.00~2.50	≤0.030	≤0.030	9.00~11.00	19.00~21.50	≤0.75	≤0.75	10xC~1.00					
TG-S310MF	-	Ar	DC-EN	•Suitable for 25%Cr-22%Ni-2%Mo stainless steel of urea plant	Ex	0.009	0.03	4.87	0.005	0.002	22.52	25.33	2.27	-	-	Ex	480	630	40	-
					Gt	≤0.02	≤0.50	3.00~5.00	≤0.030	≤0.020	21.00~23.00	24.00~26.00	1.90~2.70	-	-					
NO4051	-	Ar	DC-EN	•Suitable for modified 316 stainless steel of urea plant	Ex	0.005	0.16	6.10	0.011	0.004	16.29	18.24	2.56	-	-	Ex	360	490	41	-257°C: 99
					Gt	≤0.045	≤1.00	4.00~7.00	≤0.030	≤0.020	14.00~18.00	17.00~19.50	2.20~3.00	-	-					
TG-S329M	-	Ar	DC-EN	•Suitable for duplex stainless steel	Ex	0.010	0.26	1.10	0.003	0.001	9.21	24.71	3.26	N: 0.14	-	Ex	617	809	35	0°C: 160
					Gt	≤0.030	≤0.65	0.50~2.50	≤0.030	≤0.030	8.00~10.00	23.00~26.00	2.50~4.00	N: 0.08~0.20	-					
TG-S410	A5.9 ER410	Ar	DC-EN	•Suitable for 13%Cr stainless steel	Ex	0.10	0.34	0.49	0.008	0.006	0.41	12.83	0.50	0.01	-	Ex	310	530	37	20°C: 210
					Gt	≤0.12	≤0.50	≤0.60	≤0.030	≤0.030	≤0.60	11.50~13.50	≤0.75	≤0.75	-					
TG-S410Cb	-	Ar	DC-EN	•Suitable for 13%Cr and 13%Cr-Al stainless steel	Ex	0.09	0.41	0.47	0.016	0.004	0.10	11.68	0.05	0.03	0.89	Ex	270	540	23	20°C: 39
					Gt	≤0.12	≤0.50	≤0.60	≤0.030	≤0.030	≤0.60	11.50~13.50	≤0.75	≤0.75	0.70~1.10					

Note: Welding tests are as per AWS. Ex: Example, Gt: Guaranty

■ Approvals

TG-S317L	LR
TG-S347	NK

■ Diameter (mm)

TG-S317L	2.0, 2.4	TG-S329M	1.2, 1.6, 2.0, 2.4
TG-S347	1.2, 1.6, 2.0, 2.4, 3.2	TG-S410	1.6, 2.0, 2.4
TG-S310MF	1.6, 2.4	TG-S410Cb	0.8, 1.2, 1.6, 2.0, 2.4, 3.2
NO4051	1.2, 1.6, 2.4		

Welding Consumables and Proper Welding Conditions for

- **Shielded Metal Arc Welding (SMAW)**
- **Flux Cored Arc Welding (FCAW)**
- **Gas Metal Arc Welding (GMAW)**
- **Submerged Arc Welding (SAW)**

For Hardfacing

A guide for selecting welding consumables

Weld metal microstructure and main alloying elements determine the performances of welding consumables for hardfacing as summarized in Table 1. In addition, PF-200S/US-63B is good for reclamation of mill rolls.

Table 1 Welding consumables and their characteristics

Weld metal microstructure and alloying formula		Hv	Features	Type of wear ⁽¹⁾						
				MTM	ABR	HTW	CAV	COR	HRT	IMP
Pearlite		200-400	•Good crack resistance •Good machinability	○	△	×	-	-	×	○
Martensite		350-800	•Good wear resistance	○	○	△	-	×	△	△
13%Cr stainless steel type		350-500	•Good resistance to oxidation, heat and corrosion •Good wear resistance	○	△	○	○	○	○	△
Semi-Austenite		500-700	•High toughness and good wear resistance	○	○	△	△	△	△	△
High Mn Austenite	13%Mn	150-500	•High toughness and good impact wear resistance •High work hardenability	×	○	×	△	×	×	◎
	16%Mn-16%Cr	200-400	•High hardness at high temperatures •High toughness	○	△	○	○	○	○	○
High Cr-Fe		600-800	•Excellent erosion resistance •Good resistance to corrosion and heat	△	◎	◎	×	○	○	×
Tungsten carbide type		800-1200	•Excellent resistance to heavy abrasion	×	◎	×	×	×	×	×

Note (1) MTM: Metal-to-metal wear, ABR: Abrasion, HTW: High temp. wear, CAV: Cavitation, COR; Corrosion wear, HRT: Heat resistance, IMP: Impact wear
◎: Excellent resistance, ○: Good resistance, △: Slightly inferior, ×: Inferior, -: Not used for general applications

SMAW	FCAW	GMAW	SAW
HF-240 HF-260 HF-330 HF-350	DW-H250 DW-H350	MG-250 MG-350	G-50/US-H250N G-50/US-H350N
HF-450 HF-500 HF-600 HF-650 HF-700 HF-800K	DW-H450 DW-H600 DW-H700 DW-H800	-	G-50/US-H400N G-50/US-H450N G-50/US-H500N MF-30/US-H550N MF-30/US-H600N
HF-13	-	-	-
HF-12	-	-	-
HF-11	DW-H11	-	-
HF-16	DW-H16	-	-
HF-30	DW-H30 DW-H30MV	-	-
HF-950 HF-1000	-	-	-

For Hardfacing

■ Tips for better welding results

Common to individual welding processes

Important points in hardfacing are to obtain sufficient hardness and to minimize cracking. In order to achieve them, proper selection of welding consumables and proper welding procedures mentioned below are necessary.

1) Preparation of base metal:

Rust, oil and soil attached on the base metal may cause blowholes. Cracks in the base metal may cause cracking of the weld metal; therefore, they must be removed completely beforehand.

2) Preheat and interpass temperature:

In order to minimize cracking, control of preheat and interpass temperature is a key technique. Table 1 shows a rule of thumb for proper preheat and interpass temperatures in relation to the carbon equivalent of the base metal. In practice, size of work, type of welding consumable and method of hardfacing should be taken into consideration to determine the most appropriate temperatures.

Table 1 A rule of thumb for preheat and interpass temperature in relation to base metal carbon equivalents

Type of steel	Carbon equivalent ⁽¹⁾	Preheat and interpass temperature (°C)
Carbon steel and Low alloy steel	Less than 0.3	100 max.
	0.3-0.4	100 min.
	0.4-0.5	150 min.
	0.5-0.6	200 min.
	0.6-0.7	250 min.
	0.7-0.8	300 min.
High-Mn steel (13%Mn steel)	Over 0.8	350 min.
		Use no preheat and cool each weld pass with water
Austenitic stainless steel		Use no preheat and control the interpass temperature 150°C or lower
High alloy steel (e.g., High-Cr steel)		400 min.

Note (1) Carbon equivalent = $C + Mn/6 + Si/24 + Cr/5 + Mo/4 + Ni/15$

3) Immediate postweld heating:

Heating the weldment at 300-350°C for 10-30 minutes just after welding was finished is effective to prevent cold cracking. Control the temperature carefully, or the hardness of the weld will be decreased by excessive heating.

4) Postweld heat treatment:

Postweld heat treatment (PWHT) at 550-750°C is effective to prevent cold cracking and distortion in service, and to improve properties of the welds. It is important to set the PWHT conditions taking into account that the hardness of the weld is normally decreased by PWHT.

5) Underlaying:

Underlaying is effective to prevent cracking in welds where low-alloy steel having high hardenability is hardfaced or where high-hardness weld metal is deposited on carbon steel. For underlaying, mild steel type welding consumables or austenitic stainless steel type welding consumables should be used.

6) Penetration:

In hardfacing, the properties of the weld metal will considerably be affected by welding penetration into the base metal, because the chemical composition of the welding consumable is generally very different from those of the base metal. In order to use sufficiently the desired properties of the welding consumable, welding penetration must be controlled by using an appropriate welding procedure, for instance, multi-layer welding.

7) Welding distortion:

Intermittent and symmetrical welding sequences are effective to minimize welding distortion. Restraint of the work is also effective to minimize welding distortion.

SMAW

- 1) Control the arc length as short as possible.
- 2) Use the backstep method for arc starting to prevent blowholes.
- 3) Control the weaving width less than 3-4 times the diameter of a covered electrode.
- 4) Re-dry covered electrodes before use.

FCAW, GMAW

- 1) Control shielding gas flow rates within 20-25 l/mm for general applications. Note that poor shielding due to low flow rates and wind can cause blowholes and pits in the weld metal.
- 2) Refer to proper currents for individual wire sizes as shown in Table 2.

Table 2 Proper welding currents

Type of wire	Diameter (mm)	Polarity	Welding current (A)
DW-H series	1.2	DC-EP	120-360
	1.6	DC-EP	200-420
MG series	1.2	DC-EP	120-320
	1.6	DC-EP	200-420

Covered Electrodes for Hardfacing

Trade designation	Nominal hardness	Type of covering	Pol.	Features	WP	Chemical C	composition of overlay weld metal (%)			Hardness of weld metal		Pre. H & IPT		
							Si	Mn	Cr	PWHT	Hv			
HF-240	Hv 240	Titania	AC DC-EP	•Hardfacing of gears and wheels •RC: 70~100°Cx0.5~1h	F V OH	Ex	0.09	0.58	0.58	0.81	Ex	AW	240	≥ 150°C
												900°C,OQ	350	
HF-260	Hv 260	Low hydrogen	AC DC-EP	•Hardfacing of shafts, crane wheels and couplings •RC: 300~350°Cx0.5~1h	F	Ex	0.17	0.69	1.81	-	Ex	AW	271	≥ 150°C
												900°C,OQ	395	
HF-330	Hv 330	Titania	AC DC-EP	•Hardfacing of keys and clutch lugs •RC: 70~100°Cx0.5~1h	F	Ex	0.10	0.69	0.86	2.29	Ex	AW	340	≥ 150°C
												-	-	
HF-350	Hv 350	Low hydrogen	AC DC-EP	•Hardfacing of upper rollers and sprockets of bulldozers •RC: 300~350°Cx0.5~1h	F V OH	Ex	0.25	0.49	1.38	1.16	Ex	AW	366	≥ 150°C
												850°C,OQ	510	

Note: Welding tests are as per Kobe Steel's Standard. Ex: Example (polarity: AC)

■ Diameter and Length (mm)

Dia.	2.6	3.2	4.0	5.0	6.0
HF-240	-	350	400	400	450
HF-260	300	350	400	400	450
HF-330	-	350	400	400	450
HF-350	300	350	400	400	450

Covered Electrodes for Hardfacing

Trade designation	Nominal hardness	Type of covering	Pol.	Features	WP	Chemical C	composition of overlay weld metal (%)							Hardness of weld metal			
							Si	Mn	Cr	Mo	V	W	PWHT (°C×h)	Hv	Pre. H & IPT		
HF-450	Hv 450	Low hydrogen	AC DC-EP	▪Hardfacing of idlers, rollers and truck links of bulldozers ▪RC: 300~350°Cx0.5~1h	F	Ex	0.20	1.30	0.31	2.54	0.60	0.23	-	Ex	AW	456	≥150°C
															550×6	443	
HF-500	Hv 500	Low hydrogen	AC DC-EP	▪Hardfacing of idlers and truck links of bulldozers ▪RC: 300~350°Cx0.5~1h	F	Ex	0.45	1.37	0.91	-	0.98	0.28	-	Ex	AW	517	≥150°C
HF-600	Hv 600	Low hydrogen	AC DC-EP	▪Hardfacing of lower rollers and bucket edges ▪RC: 300~350°Cx0.5~1h	F	Ex	0.48	0.77	2.58	2.50	-	-	-	Ex	AW	595	≥200°C
HF-650	Hv 650	Low hydrogen	AC DC-EP	▪Hardfacing of tamping dies and mixer blades ▪RC: 300~350°Cx0.5~1h	F	Ex	0.67	0.90	0.87	4.91	1.17	0.55	1.42	Ex	AW	634	≥200°C
															600×1, AC	580	

Note: Welding tests are as per Kobe Steel's Standard. Ex: Example (polarity: AC)

Diameter and Length (mm)					
Dia.	2.6	3.2	4.0	5.0	6.0
HF-450	-	-	400	400	450
HF-500	-	350	400	400	450
HF-600	300	350	400	400	450
HF-650	300	350	400	400	450

Covered Electrodes for Hardfacing

Trade designation	Nominal hardness	Type of covering	Pol.	Features	WP		C	Chemical composition of overlay weld metal (%)						Hardness of weld metal			
								Si	Mn	Cr	Mo	W	B	PWHT (°Cxh)	Hv	Pre. H, & IPT	
HF-700	Hv 700	Low hydrogen	AC DC-EP	•Hardfacing of cutter knives and casings •RC: 300~350°Cx0.5~1h	F	Ex	0.62	0.80	0.78	5.12	2.21	-	-	Ex	AW	654	≥200°C
															600x1, AC	485	
HF-800K	Hv 800	Low hydrogen	AC DC-EP	•Hardfacing of cutter knives and casings •RC: 300~350°Cx0.5~1h	F	Ex	0.80	1.65	1.24	3.82	-	2.42	0.29	Ex	AW	736	≥200°C
															600x1, AC	535	
HF-950	Hv 950	Graphite	AC DC-EP	•Hardfacing of shovel teeth and cutter knives •RC: 150~200°Cx0.5~1h	F	Ex	3.5	0.1	2.6	-	-	26	-	Ex	AW	930	≥300°C

Note: Welding tests are as per Kobe Steel's Standard. Ex: Example (polarity: AC)

Diameter and Length (mm)				
Dia.	3.2	4.0	5.0	6.0
HF-700	-	400	400	450
HF-800K	350	400	400	450
HF-950	-	400	400	

Covered Electrodes for Hardfacing

Trade designation	Nominal hardness	Type of covering	Pol.	Features	WP	C	Chemical composition of overlay weld metal (%)						Hardness of weld metal		
							Si	Mn	Cr	Mo	V	Ni	PWHT (°Cxh)	Hv	
HF-11	Hv 250	Low hydrogen	AC DC-EP	•Hardfacing of crusher hammers and crusher jaws •RC: 150~200°Cx0.5~1h	F Ex	0.82	0.39	13.88	-	-	-	-	Ex	AW	266
HF-12	Hv 500	Low hydrogen	AC DC-EP	•Hardfacing of ripper teeth, impellers and breakers •RC: 300~350°Cx0.5~1h	F Ex	0.72	0.89	1.17	7.30	1.12	-	-	Ex	AW	532
														500×2	630
HF-13	Hv 450	Low hydrogen	AC DC-EP	•Hardfacing of valve seats and agitator propellers •RC: 300~350°Cx0.5~1h	F Ex	0.13	0.50	0.74	12.97	0.97	-	0.99	Ex	AW	420
														750×1	260
HF-16	Hv 300	Low hydrogen	AC DC-EP	•Hardfacing of hot shears and hot dies •RC: 150~200°Cx0.5~1h	F Ex	0.71	0.48	14.59	15.33	1.85	0.42	2.20	Ex	AW	306
HF-30	Hv 700	Low hydrogen	AC DC-EP	•Hardfacing of crusher rotors and liners •RC: 300~350°Cx0.5~1h	F Ex	5.00	0.42	1.23	30.5	-	-	-	Ex	AW	770

Note: Welding tests are as per Kobe Steel's Standard. Ex: Example (polarity: AC)

Diameter and Length (mm)					
Dia.	2.6	3.2	4.0	5.0	6.0
HF-11	-	350	400	400	450
HF-12	300	350	400	400	450
HF-13	-	350	400	400	-
HF-16	-	300	350	350	-
HF-30	-	-	400	450	-

Trade designation	Nominal hardness	Type of cored flux	SG	Pol.	Features	WP	Chemical composition of overlay weld metal (%)							Hardness of weld metal			
							C	Si	Mn	Cr	Mo	Others	PWHT (°C×h)	Hv	Pre. H, & IPT		
DW-H250	Hv 250	Rutile	CO ₂	DC-EP	•Suitable for metal-to-metal wear parts and underlaying for hardfacing and repair	F HF	Ex	0.09	0.49	1.30	1.02	0.40	-	Ex	AW 600x2	269 270	≥ 150°C
DW-H350	Hv 350	Rutile	CO ₂	DC-EP	•Suitable for metal-to-metal wear and light abrasion parts	F HF	Ex	0.13	0.64	1.70	0.48	0.53	-	Ex	AW 600x2	370 297	≥ 150°C
DW-H450	Hv 450	Rutile	CO ₂	DC-EP	•Suitable for metal-to-metal wear and abrasion parts	F HF	Ex	0.15	0.57	1.40	3.70	0.47	V: 0.25	Ex	AW 600x2	431 384	≥ 150°C
DW-H600	Hv 600	Rutile	CO ₂	DC-EP	•Suitable for abrasion parts	F HF	Ex	0.45	0.48	0.97	4.31	0.51	-	Ex	AW 600x2	574 398	≥ 200°C
DW-H700	Hv 700	Rutile	CO ₂	DC-EP	•Suitable for abrasion parts	F HF	Ex	0.57	0.73	1.05	5.40	1.01	V: 0.54 W: 1.21	Ex	AW 600x2	673 605	≥ 250°C
DW-H800	Hv 800	Metal	CO ₂	DC-EP	•Suitable for heavy abrasion parts	F HF	Ex	1.10	0.68	1.83	4.22	-	W: 2.26 B:0.54	Ex	AW 600x2	772 612	≥ 250°C

Note: Welding tests are as per Kobe Steel's Standard. Ex: Example

■ Diameter (mm)

DW-H250	1.2, 1.6
DW-H350	1.2, 1.6
DW-H450	1.2, 1.6
DW-H600	1.2, 1.6
DW-H700	1.2, 1.6
DW-H800	1.2, 1.6

Trade designation	Nominal hardness	Type of cored flux	SG	Pol.	Features	WP	Chemical composition of overlay weld metal (%)							Hardness of weld metal			
							C	Si	Mn	Cr	Mo	Others	PWHT	Hv	Pre. H, & IPT		
DW-H11	Hv 250	Metal	Ar-CO ₂	DC-EP	•Suitable for abrasion accompanied by heavy impact parts and repair welding of 13%-Mn cast steel	F HF	Ex	0.84	0.68	14.17	-	-	-	Ex	AW	233	-
DW-H16	Hv 300	Metal	Ar-CO ₂	DC-EP	•Suitable for high temperature wear, impact wear and cavitation parts such as hot shear bytes, hot saws, and hydraulic power water turbines	F HF	Ex	0.60	0.51	16.76	16.21	1.49	V: 0.49	Ex	AW	278	≥150°C
DW-H30	Hv 700	Metal	CO ₂	DC-EP	•Suitable for heavy abrasive parts such as crushers and hoppers	F HF	Ex	2.92	1.16	0.16	24.06	-	B:0.3	Ex	AW	755	≥250°C
DW-H30MV	Hv 800	Metal	CO ₂	DC-EP	•Suitable for heavy abrasive and high temperature wear parts such as liners, screws, and crushers	F HF	Ex	5.03	2.39	0.19	21.60	0.94	B:0.28 V: 2.61	Ex	AW	821	≥200°C

Note: Welding tests are as per Kobe Steel's Standard. Ex: Example

■ Diameter (mm)

DW-H11	1.6
DW-H16	1.2
DW-H30	1.2, 1.6
DW-H30MV	1.2, 1.6

Flux and Wire Combinations for Hardfacing

Trade designation	Nominal hardness	Type of flux	Pol.	Features		Chemical composition of overlay weld metal (%)						Hardness of weld metal		
						C	Si	Mn	Cr	Mo	V	PWHT (°C×h)	Hv	
^[F] G-50 / ^[P] US-H250N	Hv 250	Fused	AC	•Suitable for hardfacing of wheels and rollers and for underlaying of idlers and rollers •RC: 150~350°Cx1h	Weld-Ex	0.06	0.60	1.82	-	0.62	-	Ex	AW	267
^[F] G-50 / ^[P] US-H350N	Hv 350	Fused	AC	•Suitable for hardfacing of idlers and links of tractors and shovels, rollers for steel mills, and tires ,and hutches •RC: 150~350°Cx1h	Weld-Ex	0.10	0.63	1.95	1.10	0.52	-	Ex	AW	361
^[F] G-50 / ^[P] US-H400N	Hv 400	Fused	AC	•Suitable for hardfacing of idlers and links of tractors and shovels, rollers for steel mills, and tires •RC: 150~350°Cx1h	Weld-Ex	0.13	0.65	2.02	2.21	0.36	0.17	Ex	AW	409
^[F] G-50 / ^[P] US-H450N	Hv 450	Fused	AC	•Suitable for hardfacing of rollers and idlers of tractors and shovels, rollers for steel mills, and bells for blast furnaces •RC: 150~350°Cx1h	Weld-Ex	0.19	0.72	2.22	2.69	0.60	0.31	Ex	AW 600x 5	453 431

Note: Welding tests are as per Kobe Steel's Standard, Wire-Ex: Example of wire,

Weld-Ex: Example of weld metal, Ex: Example of weld metal (polarity: AC)

Diameter of wire (mm)		Mesh size of flux	
US-H250N	3.2	G-50	8x48
US-H350N	3.2		
US-H400N	3.2, 4.0		
US-H450N	3.2, 4.0		

Flux and Wire Combinations for Hardfacing

Trade designation	Nominal hardness	Type of flux	Pol.	Features		Chemical composition of overlay weld metal (%)							Hardness of weld metal		
						C	Si	Mn	Cr	Mo	W	V	PWHT (°Cxh)	Hv	
[F]G-50/ [P]US-H500N	Hv 500	Fused	AC	▪Suitable for hardfacing of rollers and idlers of tractors and shovels, rollers for steel mills, and bells for blast furnaces ▪RC: 150~350°Cx1h	Weld-Ex	0.22	0.85	2.26	2.85	1.10	1.45	0.32	Ex	AW	509
														600x2	506
[P]MF-30/ [P]US-H550N	Hv 550	Fused	AC	▪Suitable for hardfacing of rollers for steel mills, and bells for blast furnaces ▪RC: 150~350°Cx1h	Weld-Ex	0.34	0.58	2.12	6.72	3.75	-	-	Ex	AW	540
														600x2	503
[P]MF-30/ [P]US-H600N	Hv 600	Fused	AC	▪Suitable for hardfacing of rollers for steel mills, and crusher cones ▪RC: 150~350°Cx1h	Weld-Ex	0.38	0.63	2.19	6.96	3.72	-	-	Ex	AW	596
														600x2	570

Note: Welding tests are as per Kobe Steel's Standard. Wire-Ex: Example of wire,

Weld-Ex: Example of weld metal, Ex: Example of weld metal (polarity: AC)

Diameter of wire (mm)		Mesh size of flux	
US-H500N	3.2	G-50	8x48
US-H550N	3.2	MF-30	12x65
US-H600N	3.2		

Welding Consumables and Proper Welding Conditions for

■ **Shielded Metal Arc Welding (SMAW)**

For Cast Iron

■ A guide for selecting welding consumables

Table 1 shows covered electrodes for shielded metal arc welding of cast irons in conjunction with weldability, usability, color matching, and machinability.

Table 1 Welding consumables for cast irons ⁽¹⁾

Trade designation	Preheat temperature (°C)	Wettability with base metal	Color matching with base metal	Joint efficiency	X-ray soundness	Machinability of weld metal	Machinability of HAZ
CI-A1	100-300	○	△	◎	○	◎	◎
CI-A2	150-350	◎	△	◎	○	◎	○
CI-A3	350-400	◎	◎	○	○	△	△
CI-A5	100-250	◎	◎	◎	○	○	△

Note (1) ◎: Good, ○: Better, △: Inferior

■ Tips for better welding results

1) Preparation for base metal:

- (1) When cast irons have impregnated oil, the base metal must be heated at 400°C to burn off the oil before welding. Other contaminants should also be removed off before welding.
- (2) To repair a defect, it must be removed completely by machining or grinding (arc air gouging is not suitable for cast irons) before welding. The welding groove should have a round bottom for better fusion. Where a crack defect seems to be propagated by machining or grinding, make stop-holes at both ends of the crack.

2) Welding procedure:

- (1) The most appropriate preheating temperature depends on the size and thickness of the work; however, Table 1 can be a rule of thumb.
- (2) Stringer welding with the maximum bead length of about 50 mm is recommended to prevent overheating, distortion and cracking.
- (3) Peening is needed to minimize residual stresses. Just after one bead was laid, it must be peened with a hammer to the extent that the ripple of the bead disappears.
- (4) Comparatively small conical groove should be welded in the spiral sequence from the bottom of the groove to the surface of the base metal. Backstep, symmetrical or intermittent sequence is recommended for a long welding line to prevent cracking. The buttering method, in which the surface of the groove is clad first and the filling passes are laid later, is recommended for a deep groove.

Covered Electrodes for Cast Iron

Trade designation	ASME AWS Class.	Type of covering	Pol.	Features	WP	Chemical composition of all-weld metal (%)										Mechanical properties of all-weld metal	
						C	Si	Mn	P	S	Ni	Fe	Others	TS (MPa)	EI (%)		
CI-A1	A5.15 ENi-CI	Graphite	AC	<ul style="list-style-type: none"> •Suitable for repairing and joining various kinds of cast irons •Excellent welding usability and machinability •RC: 70~100°Cx0.5~1h 	F	Ex	0.99	0.11	0.57	0.002	0.001	Bal.	1.71	-	Ex	480	-
			DC-EP			Gt	≤1.80	≤1.00	≤1.00	≤0.040	≤0.030	≥92.0	≤5.00	-			
CI-A2	A5.15 ENiFe-CI	Graphite	AC	<ul style="list-style-type: none"> •Suitable for repairing and joining various kinds of cast irons •Crack resistibility is excellent •RC: 70~100°Cx0.5~1h 	F	Ex	1.15	0.31	1.96	0.004	0.001	54.8	Bal.	-	Ex	520	-
			DC-EP			Gt	≤2.00	≤2.50	≤2.50	≤0.040	≤0.030	45.0~60.0	Bal.	-			
CI-A3	A5.15 ESt	Low hydrogen	AC	<ul style="list-style-type: none"> •Suitable for repairing and joining various kinds of cast irons •Hardenability of the fusion zone is larger than with Ni-bearing electrodes •RC: 300~350°Cx0.5~1h 	F	Ex	0.04	0.50	0.48	0.006	0.002	-	Bal.	-	Ex	490	33
			DC-EP			Gt	≤0.15	≤1.00	≤0.80	≤0.030	≤0.020	-	Bal.	-			
CI-A5	-	Low hydrogen	AC	<ul style="list-style-type: none"> •Suitable for repairing and joining various kinds of cast irons •RC: 300~350°Cx0.5~1h 	F	Ex	0.05	0.89	0.03	0.009	0.006	-	Bal.	V: 10.3 Cr: 1.3	Ex	540	34
			DC-EP			Gt	≤0.15	≤1.50	≤0.50	≤0.030	≤0.030	-	Bal.	V: 8.00~ 11.50 Cr: ≤2.00			

Note: Welding tests are as per AWS. Ex: Example (polarity: AC),

Gt: Guaranty (polarity: as specified above)

Diameter and Length (mm)

	Dia.	2.6	3.2	4.0	5.0
CI-A1	-	-	350	350	350
CI-A2	300	300	350	-	-
CI-A3	300	350	400	-	-
CI-A5	-	350	400	-	-

Welding Consumables and Proper Welding Conditions for

- **Shielded Metal Arc Welding (SMAW)**
- **Flux Cored Arc Welding (FCAW)**
- **Gas Metal Arc Welding (GMAW)**
- **Gas Tungsten Arc Welding (GTAW)**
- **Submerged Arc Welding (SAW)**

Inconel, Incoloy and Monel are trademarks of Special Metals Corporation.
Hastelloy is a trademark of Haynes International.

For 9%Ni Steel and Nickel-Based Alloy

For 9%Ni Steel

For welding of 9%Ni steel, Ni-base alloys such as Ni-Cr alloy (e.g., Inconel) and Ni-Mo alloy (e.g., Hastelloy) welding consumables are commonly used to obtain sufficient notch toughness at cryogenic temperatures. 9%Ni steel is used for storage tanks for liquefied natural gas (LNG), liquefied oxygen and liquefied nitrogen, and LNG carriers. In the construction of such cryogenic temperature service equipment, automatic gas tungsten arc welding and submerged arc welding are often used to ensure consistent weld quality, as shown in Fig. 1.

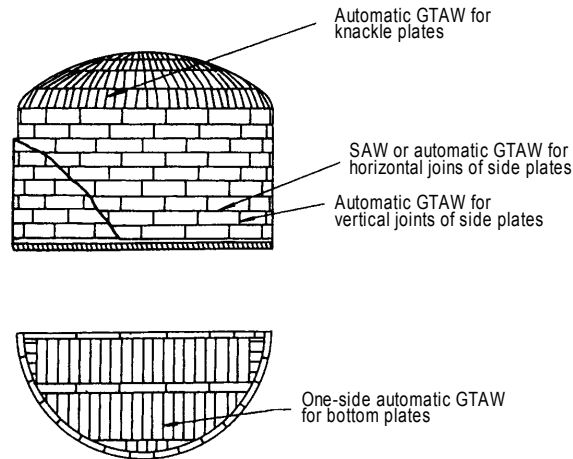

Fig. 1 Typical applications of automatic welding processes for a LNG storage tank

■ Tips for better welding results

Common to individual welding processes

- (1) Remove scale, rust, and other dirt from welding grooves beforehand by grinding or other appropriate means.
- (2) Use no preheat and control interpass temperatures at 150°C or lower.
- (3) Minimize welding currents and welding speeds to prevent hot cracking.
- (4) Use no magnetic power crane because 9%Ni steel is likely to be magnetized.

SMAW

- (1) Re-dry covered electrodes by 200-250°C for 30-60 minutes before use.
- (2) Keep the arc length as short as possible.

FCAW, GMAW

- (1) Use Ar-CO₂ mixtures with 20-25%CO₂ for shielding gas. The gas flow rates should be 20-25 l/min.
- (2) Refer to Pages 211 and 213 of the stainless steel article about power source, wire extension, protection against wind and welding fumes, and storage of welding wires.

GTAW

- (1) Use multi-pass welding because the use of single-pass welding may cause a decrease of weld metal strength affected by the dilution from the base metal.

SAW

- (1) Re-dry fluxes by 200-300°C for 1 hour before use.
- (2) Use multi-pass welding because the use of single-pass welding may cause a decrease of weld metal strength affected by the dilution from the base metal.

For Ni-base alloy

Typical Ni-base alloys for welding are Ni-Cu alloy (e.g. Monel), Ni-Cr alloy (e.g. Inconel) and Ni-Fe-Cr alloys (e.g. Incoloy). Ni-base welding consumables are used for joining these Ni-base alloys and dissimilar-metal joints consisting of Ni-base alloy and low alloy steel, stainless steel, and low alloy steel.

■ Tips for better welding results for individual welding processes

SMAW

- (1) Use proper welding currents because the use of an excessive welding current causes electrode-burn and thereby usability and weld metal properties can be deteriorated.
- (2) Use no preheating for welding matching Ni-base alloys. Control interpass temperatures at 150°C or lower.
- (3) Use the backstep technique when an arc is struck in the welding groove, or strike an arc on a piece of metal outside the groove to prevent the occurrence of blowholes at the arc starting area of a bead.
- (4) Keep the arc length as short as possible.
- (5) Use flat-position welding as much as possible because vertical or overhead welding requires higher welding skill.
- (6) Minimize welding currents and speeds to prevent hot cracking.

FCAW

- (1) Use Ar-CO₂ mixtures with 20-25%CO₂ for shielding gas. The gas flow rates should be 20-25 l/min.
- (2) Refer to Page 211 of the stainless steel article about power source, wire extension, protection against wind and welding fumes, and storage of welding wires.

GMAW

- (1) Pulsed arc welding with the spray droplet transfer mode using low currents is most appropriate, although conventional gas metal arc welding power sources can be used. DC-EP polarity is suitable.
- (2) Argon gas shielding with gas flow rates in the 25-30 l/min range is suitable. Ar-He mixture gases are also suitable.
- (3) Use no preheating and control interpass temperatures at 150°C or lower.
- (4) Minimize welding currents and speeds to prevent hot cracking.

GTAW

- (1) Use DC-EN polarity.
- (2) Argon gas shielding with gas flow rates in the 10-15 l/min range is suitable where welding currents are within 100-200A. In one-side welding, back shielding is needed to avoid oxidation of the back side bead.
- (3) Control the arc length at approximately 2-3 mm because the use of an excessive arc length may cause lack of shielding, thereby causing blowholes.
- (4) Use no preheating and control interpass temperatures at 150°C or lower.
- (5) Minimize welding currents and speeds to prevent hot cracking.

For 9%Ni Steel and Nickel-Based Alloy

How to select the proper welding consumable for dissimilar metal joints

Recommended welding consumables for dissimilar metal joints and preheat temperatures are shown in Table 1. ⁽¹⁾⁽²⁾

Table 1 Recommended welding consumables for dissimilar metal joints

Base metal: A		Carbon steel and low alloy steel	Nickel and	
Base metal: B			Inconel	Incoloy
Stainless steel	Austenitic	NC-39, NC-39L NC-39MoL NI-C70A ⁽³⁾ 100~200°C	NI-C70A NI-C625 —	NI-C70A NI-C625 —
	Martensitic	NC-39, NC-39L CR-43Cb ⁽⁴⁾ NI-C70A ⁽³⁾ 200~400°C	NI-C70A 100~300°C	NI-C70A 100~300°C
	Ferritic	NC-39, NC-39L CR-43Cb ⁽⁴⁾ NI-C70A ⁽³⁾ 100~300°C	NI-C70A 100~200°C	NI-C70A 100~200°C
Nickel and nickel alloy	Nickel	NI-C70A 100~200°C	NI-C70A —	NI-C70A —
	Monel	NI-C70A ME-L34 100~200°C	NI-C70A ME-L34 —	NI-C70A ME-L34 —
	Incoloy	NI-C70A NI-C625 100~200°C	NI-C70A NI-C625 —	
	Inconel	NI-C70A NI-C625 100~200°C		

nickel alloy		Stainless steel	
Monel	Nickel	Ferritic	Martensitic
NI-C70A ME-L34 —	NI-C70A —	NC-39, NC-39L NI-C70A ⁽³⁾ 100~200°C	NC-39, NC-39L NI-C70A ⁽³⁾ 100~300°C
NI-C70A ME-L34 100~300°C	NI-C70A 100~300°C	NC-39 CR-43Cb ⁽⁵⁾ CR-40Cb ⁽⁵⁾ 200~400°C	
NI-C70A ME-L34 100~200°C	NI-C70A 100~200°C		
NI-C70A ME-L34 —			

- Note: (1) This table shows only covered electrodes for SMAW. Other welding consumables having the similar chemical composition for GTAW, GMAW, and FCAW can also be used. Instead of NI-C70A, NI-C703D can also be used.
- (2) The preheat temperature in this table is a rough guide. In a case where the welding joint consists of thick plates and is restrained to a great extent, a higher temperature may be necessary. Even when preheat temperature is given for particular dissimilar metal joints, austenitic stainless steel, nickel, and nickel alloy need not be preheated, and the counterpart base metals such as carbon steel, martensitic stainless steel, and ferritic stainless steel should be preheated sufficiently. In addition, for a dissimilar metal joint consisting of carbon steel (Base metal: A) and austenitic stainless steel, nickel, or nickel alloy (Base metal: B), both base metals need not be preheated.
- (3) In a case where the weld is used at about 400°C or higher or under thermal cycles, NI-C70A should be selected.
- (4) In a case where Ni is restricted in a special service environment, CR-43Cb should be used.
- (5) In a case where Ni is restricted in a special service environment, CR-43Cb or CR-40Cb should be selected

Covered Electrodes for 9%Ni steel

Trade designation	ASME AWS Class.	Type of covering	Pol.	Features	WP	Chemical			composition of all-weld metal (%)						Mechanical properties of all-weld metal					
						C	Si	Mn	Ni	Cr	Nb	Fe	Mo	Others	0.2%OS (MPa)	TS (MPa)	EI (%)	IV (J)		
NI-C70S	A5.11 ENiCrFe-9	Low hydrogen	AC	•Suitable for 9% Ni steel •RC: 200~250°Cx 0.5~1h	F HF H VU OH	Ex	0.09	0.26	2.26	67.60	13.90	1.70	9.80	3.70	W: 0.6	Ex	430	680	41	-196°C: 67
						Gt	≤0.15	≤0.75	1.00~ 4.50	≥55.00	12.00~ 17.00	0.50~ 3.00	≤12.00	2.50~ 5.50	W ≤1.5	Gt	-	≥650	≥25	-
NI-C1S	A5.11 ENiMo-8	Low hydrogen	AC	•Suitable for 9% Ni steel •RC: 200~250°Cx 0.5~1h	F HF H VU OH	Ex	0.03	0.49	0.28	68.60	1.90	-	6.80	18.60	W: 2.9	Ex	440	730	48	-196°C: 83
						Gt	≤0.10	≤0.75	≤1.50	≥60.00	0.50~ 3.50	-	≤10.00	17.00~ 20.00	W: 2.0~ 4.0	Gt	-	≥650	≥25	-

Note: Welding tests are as per AWS. Ex: Example, Gt: Guaranty (polarity: AC)

■ Approvals

NI-C70S	NK
NI-C1S	NK

■ Diameter and Length (mm)

Dia.	2.6	3.2	4.0	5.0
NI-C70S	-	300	350	350
NI-C1S	-	300	350	350

Covered Electrodes for Nickel-Based Alloy

Trade designation	ASME AWS Class.	Type of covering	Pol.	Features	WP	Chemical			composition of all-weld metal (%)						Mechanical properties of all-weld metal					
						C	Si	Mn	Ni	Cr	Nb	Fe	Mo	Others	0.2%OS (MPa)	TS (MPa)	EI (%)	IV (J)		
ME-L34	-	Lime titania	DC-EP	<ul style="list-style-type: none"> •Suitable for monel metal and dissimilar-metal joints and overlaying •DC-EP is only applicable. •RC: 150~200°Cx 0.5~1h 	F H VU OH	Ex	0.03	0.80	3.26	65.21	-	1.81	1.58	-	Cu: Bal Al: 0.25 Ti: 0.61	Ex	320	550	44	-
						Gt	≤0.15	≤1.25	≤4.0	62.0~70.0	-	≤3.0	≤2.5	-	Cu: Bal Al≤1.0 Ti≤1.5	Gt	-	≥490	≥30	-
NI-C70A	A5.11 ENiCrFe-1	Low hydrogen	AC	<ul style="list-style-type: none"> •Suitable for Inconel and dissimilar- metal joints such as Inconel to low alloy steel, and stainless steel to low alloy steel •AC is only applicable. •RC: 200~250°Cx 0.5~1h 	F HF H VU OH	Ex	0.04	0.25	2.84	70.66	14.75	1.94	9.24	-	Co: 0.03	Ex	380	610	44	-196°C: 93
						Gt	≤0.08	≤0.75	≤3.50	≥62.00	13.00~17.00	1.50~4.00	≤11.00	-	Co ≤0.12	Gt	-	≥550	≥30	-
NI-C703D	A5.11 ENiCrFe-3	Low hydrogen	DC-EP	<ul style="list-style-type: none"> •Suitable for Inconel and dissimilar-metal joints such as Inconel to low alloy steel, and stainless steel to low alloy steel •DC-EP is only applicable. •RC: 200~250°Cx 0.5~1h 	F HF H VU OH	Ex	0.06	0.34	6.55	69.40	13.21	2.00	7.90	Ti: 0.01	Co: 0.03	Ex	360	620	45	-196°C: 110
						Gt	≤0.10	≤1.0	5.00~9.50	≥59.00	13.00~17.00	1.00~2.50	≤10.00	≤1.00	Co ≤0.12	Gt	-	≥550	≥30	-
NI-C625	-	Low hydrogen	AC DC-EP	<ul style="list-style-type: none"> •Suitable for Inconel 625, Incoloy 825, dissimilar-metal joints and overlaying •RC: 200~250°Cx 0.5~1h 	F HF H VU OH	Ex	0.04	0.32	0.67	61.10	21.65	3.41	3.66	8.70	-	Ex	420	760	47	-
						Gt	≤0.10	≤0.75	≤1.00	≥55.0	20.00~23.00	3.15~4.15	≤7.00	8.00~10.00	-	Gt	-	≥690	≥30	-

Note: Welding tests are as per AWS. Ex: Example, Gt: Guaranty (Polarity: as specified above)

■ Diameter and Length (mm)

Dia.	2.6	3.2	4.0	5.0
ME-L34	-	350	400	400
NI-C70A	-	300	350	350
NI-C703D	250	300	350	350
NI-C625	-	300	350	350

Trade designation	ASME AWS Class.	Type of cored flux	SG	Pol.	Features	WP	Chemical	composition of all-weld metal (%)						Mechanical properties of all-weld metal				
								C	Si	Mn	P	S	Ni	0.2%OS (MPa)	TS (MPa)	EI (%)	IV (J)	
DW-N70S	-	Rutile	Ar-CO ₂	DC-EP	•Suitable for 9% Ni steel	F HF	Ex	0.046	0.20	5.91	0.003	0.002	62.61	Ex	425	716	46	-196°C: 106
							Gt	≤0.15	≤0.75	≤8.00	≤0.020	≤0.015	≥55.00					
							Ex	16.84	10.22	0.01	1.88	2.02	Gt	-	≥650	≥25	-	
							Gt	13.00~ 22.00	≤12.00	-	≤15.00	≤4.00						
DW-N82	A5.34 ENiCr3T0 -4	Rutile	Ar-CO ₂	DC-EP	•Suitable for Ni-based alloy of 600 and dissimilar-metal joints such as Ni-based alloy to low alloy steel and stainless steel to low alloy steel	F HF	Ex	0.038	0.23	3.40	0.002	0.006	70.6	Ex	380	650	46	0°C: 128
							Gt	≤0.10	≤0.50	2.5~ 3.5	≤0.03	≤0.015	≥67.0					
							Ex	21.2	< 0.01	1.51	2.30	0.31	Gt	-	≥550	≥25	-	
							Gt	18.0~ 22.0	≤0.50	≤3.0	2.0~ 3.0	≤0.75						

Note: Welding tests are as per Kobe Steel's Standard. Ex: Example, Gt: Guaranty

Diameter (mm)	
DW-N70S	1.2
DW-N82	1.2

Trade designation	ASME AWS Class.	Type of cored flux	SG	Pol.	Features	WP	Chemical	composition of all-weld metal (%)						Mechanical properties of all-weld metal				
								C	Si	Mn	P	S	Ni	0.2%OS (MPa)	TS (MPa)	EI (%)	IV (J)	
DW-N625	A5.34 ENiCrMo 3T1-4	Rutile	Ar-CO ₂	DC-EP	•Suitable for Ni-based alloy of 625, dissimilar-metal joints and overlaying	F HF H VU	Ex	0.030	0.40	0.40	0.009	0.002	60.8	Ex	478	743	30	0°C: 60
							Gt	≤0.10	≤0.50	≤0.50	≤0.02	≤0.015	≥58.0					
							Ex	21.78	8.94	0.012	4.04	3.41	0.15	Gt	-	≥690	≥25	-
							Gt	20.0~23.0	8.0~10.0	≤0.50	≤5.0	3.15~4.15	≤4.0					
DW-N625M	-	Rutile	Ar-CO ₂	DC-EP	•Suitable for super stainless steels, dissimilar-metal joints and overlaying	F HF	Ex	0.021	0.60	2.61	0.004	0.004	60.81	Ex	460	730	42	0°C: 68
							Gt	≤0.10	≤0.75	2.00~3.50	≤0.030	≤0.020	≥55.00					
							Ex	21.20	9.94	0.01	3.02	1.98		Gt	-	≥690	≥25	-
							Gt	20.00~23.00	8.00~11.00	≤0.50	≤7.00	1.50~3.00						
DW-NC276	A5.34 ENiCrMo 4T0-4	Rutile	Ar-CO ₂	DC-EP	•Suitable for Ni-based alloy of C276 and super austenitic stainless steel	F HF H VU	Ex	0.016	0.16	0.77	0.008	0.003	58.5	Ex	466	719	46	0°C: 63
							Gt	≤0.02	≤0.2	≤1.0	≤0.03	≤0.03	Bal					
							Ex	15.06	16.19	0.022	5.37	3.67	Co:0.048 V:0.02	Gt	-	≥690	≥25	-
							Gt	14.5~16.5	15.0~17.0	≤0.50	4.0~7.0	3.0~4.5	Co≤2.5 V≤0.35					

Note: Welding tests are as per Kobe Steel's Standard. Ex: Example, Gt: Guaranty

Diameter (mm)	
DW-N625	1.2
DW-N625M	1.2
DW-NC276	1.2

Trade designation	ASME AWS Class.	SG	Pol.	Features	WP	Chemical composition of wire (%)								Mechanical properties of all-weld metal			
						C	Si	Mn	P	S	Ni	0.2%OS (MPa)	TS (MPa)	EI (%)	IV (J)		
MG-S70NCb	A5.14 ERNiCr -3	Ar	DC- EP	<ul style="list-style-type: none"> Inconel 82 type filler wire Suitable for Inconel, Incoloy, dissimilar-metal joints and overlaying on carbon steel 	F HF H VU OH	Ex	0.03	0.22	3.05	0.003	0.002	72.01	Ex	370	660	41	-196°C: 140
						Gt	≤0.10	≤0.50	2.50~ 3.50	≤0.030	≤0.015	≥67.0					
						Ex	20.01	0.28	1.73	2.63	0.01		Gt	-	≥550	≥30	-
						Gt	18.00~ 22.00	≤0.75	≤3.00	2.00~ 3.00	≤0.50						

Note: Welding tests are as per AWS. Ex: Example, Gt: Guaranty

Diameter (mm)	
MG-S70NCb	0.8, 1.2, 1.6

Trade designation	ASME AWS Class.	SG	Pol.	Features	Chemical	composition of rod and wire (%)				Mechanical properties of all-weld metal								
						C	Si	Mn	P	S	Ni	0.2%OS (MPa)	TS (MPa)	EL (%)	IV (J)			
TG-S709S	A5.14 ERNiMo-8	Ar	DC-EN	•Suitable for 9% Ni steel		Ex	0.017	0.02	0.02	0.001	0.001	69.81	Ex	460	730	47	-196°C: 160	
						Gt	≤0.10	≤0.50	≤1.0	≤0.015	≤0.015	≥60.0						
						Ex	1.97	19.07	2.99	5.56	0.01		Gt	-	≥650	≥30	-	
						Gt	0.5~3.5	18.0~21.0	2.0~4.0	≤10.0	≤0.50							
TG-S70NCb	A5.14 ERNiCr-3	Ar	DC-EN	•Suitable for Inconel and Incoloy, dissimilar-metal joints and overlaying		Ex	0.022	0.20	2.99	0.002	0.001	72.39	Ex	370	680	40	-196°C: 150	
						Gt	≤0.10	≤0.50	2.5~3.5	≤0.030	≤0.015	≥67.0						
						Ex	19.87	2.50	0.30	1.65	0.01		Gt		≤0.50			
						Gt	18.00~22.00	2.00~3.00	≤0.75	≤3.00	≤0.50							
TG-SN625	A5.14 ERNiCrMo-3	Ar	DC-EN	•Suitable for Inconel 625, dissimilar-metal joints and overlaying		Ex	0.010	0.08	0.05	0.002	0.001	63.58	Ex	480	770	41	-	
						Gt	≤0.10	≤0.50	≤0.50	≤0.020	≤0.015	≥58.0						
						Ex	21.85	8.95	3.55	0.21	0.21	1.44	0.02	Gt		≤0.50		
						Gt	20.00~23.00	8.00~10.00	3.15~4.15	≤0.40	≤0.40	≤5.00	≤0.50					

Note: Welding tests are as per AWS. Ex: Example, Gt: Guaranty

Approvals

TG-S709S	NK
----------	----

Diameter (mm)

TG-S709S	1.2, 1.6, 2.0, 2.4
TG-S70NCb	0.8, 0.9, 1.0, 1.2, 1.6, 2.0, 2.4, 3.2, 4.0
TG-SN625	1.6, 2.4

Flux and Wire Combinations for 9%Ni Steel

Trade designation	ASME AWS Class.	Type of flux	Pol.	Features	Chemical composition (%)								Mechanical properties of weld metal					
					C	Si	Mn	Ni	Cr	Mo	W	Fe	0.2%OS (MPa)	TS (MPa)	EI (%)	IV (J)		
PF-N3/ US-709S	A5.14 ERNiMo -8	Bonded	AC DC- EP	•Hastelloy type consumables •Suitable for flat welding of 9%Ni steel •RC: 200~300°Cx1h	Wire-Ex	0.02	0.01	0.01	Bal.	2.0	19.1	2.9	5.5	Ex	400	690	44	-196°C: 80
					Wire-Gt	≤0.10	≤0.50	≤1.0	≥60.0	0.5~ 3.5	18.0~ 21.0	2.0~ 4.0	≤10.0					
					Weld-Ex	0.03	0.12	1.70	64.1	1.6	16.6	2.5	14.7					
PF-N4/ US-709S	A5.14 ERNiMo -8	Bonded	DC- EP	•Hastelloy type consumables •Suitable for horizontal and horizontal fillet welding of 9%Ni steel •RC: 200~300°Cx1h	Wire-Ex	0.02	0.01	0.01	Bal.	2.0	19.1	2.9	5.5	Ex	410	680	43	-196°C: 70
					Wire-Gt	≤0.10	≤0.50	≤1.0	≥60.0	0.5~ 3.5	18.0~ 21.0	2.0~ 4.0	≤10.0					
					Weld-Ex	0.03	0.74	0.58	64.0	1.7	17.2	2.7	14.9					

Note: Welding tests are as per Kobe Steel's Standard. Wire-Ex: Example of wire, Ex: Example of weld metal (polarity: AC)

Wire-Gt: Guaranty of wire, Weld-Ex: Example of weld metal

Approvals	
PF-N4 / US-709S	NK

Diameter of wire (mm)	
US-709S	1.6, 2.4

Mesh size of flux	
PF-N3	12x48
PF-N4	12x65

Highly Efficient Welding Processes

- **FCB™ Process**
- **RF™ Process**
- **FA-B**
- **Electrogas Arc Welding**
- **Horizontal Submerged Arc Welding**
- **Enclosed Arc Welding**

FCB™ Process

Principles:

FCB™ is an automatic one-side submerged arc welding process by which a uniform reverse side bead can be obtained. Welding is conducted from the surface side of the welding groove after supplying the backing flux, MF-1R or PFI-50R, on the copper backing and pushing up the copper backing to the reverse side of the groove by the pressurized air hose.

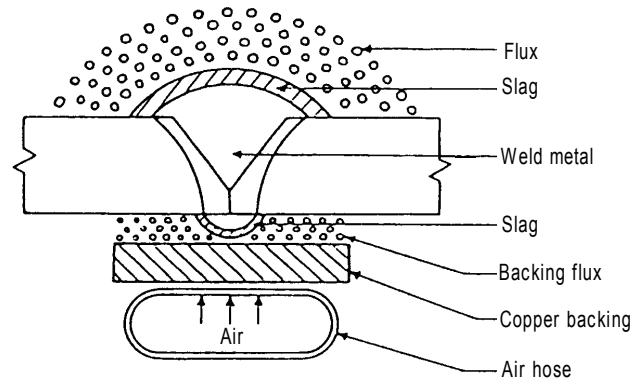

Features:

The combination of the backing flux and copper plate provides better contact onto the reverse side of the groove, which can accommodate a fluctuation of root gap and wide welding conditions to ensure consistent reverse bead without excessive melt through.

Applications:

Plate-to-plate butt welding for shipbuilding

Welding consumables

Type of steel	Flux	Wire	Backing flux	Remarks
General	PF-I50	US-43	PF-I50R or MF-1R	MF-1R is more suitable for thin plate with thickness 20 mm or less.
TMCP	PF-I55E	US-36	PF-I50R or MF-1R	

Note: Redrying conditions of flux: 200~300°Cx1h
(Backing fluxes must not be dried by heating)

Approvals : PF-I50 / US-43 / PF-I50R

Number of wires	AB	LR	NV	BV	NK	Others
Two	○	3A, 3YA	III YM	A3, 3YM	○	GL, CCS, CR
Three	○	3A, 3YA	III YM	A3, 3YM	○	CCS

○: Subject to satisfactory procedure test by user

Approvals: PF-I55E / US-36 / PF-I50R

Number of wires	AB	LR	NV	BV	NK	Others
Two	○	3A, 3YA	III Y	A3YM	○	CCS, GL, KR
Three	3*, 3Y*	3A, 3YA	III Y	A3YM	KAW53	CCS, GL, KR
Four	3*, 3Y*	3Y40A	III Y	A3YM	KAW53Y40SP	CCS

○: Subject to satisfactory procedure test by user

Packages

Wire: **US-43, US-36**

Dia. (mm)	Type	Weight (kg)
4.8	coil	25
	coil	75
	coil	150
6.4	coil	25
	coil	78
	coil	159

Flux: **PF-I45, PF-I50, PF-I55E**

Mesh size	Type	Weight (kg)
10x48	can	20

Flux: **PF-I50R, MF-1R**

Mesh size	Type	Weight (kg)
10x65	can	20

RF™ Process

Principles:

RF™ is an automatic one-side submerged arc welding process by which a uniform reverse side bead can be obtained. Welding is conducted from the surface side of the welding groove after supplying the backing flux, RF-1, which contains thermosetting resin, on the underlaying flux contained in the flux bag placed in the backing case and pushing up the fluxes onto the reverse side of the groove by the pressurized air hose.

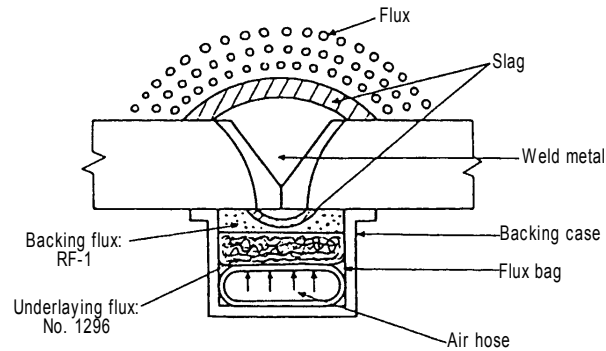

Features:

- (1) RF-1, a fine particle flux, can accommodate much more distortion in the reverse side of the groove, joint misalignment and dissimilar-thickness transition of the joint to maintain good contact onto the reverse side of the groove, which offers higher suitability for thinner plates.
- (2) RF-1 turns to be a brick by the heat of welding, maintaining close contact onto the reverse side of the groove and thereby assures a uniform reverse bead.
- (3) With a multiple-wire welding machine, one-layer completion welding can be done for steel plates with a thickness of up to approximately 25 mm.

Applications:

Plate-to-plate butt welding for steel structures, ships and bridges, and butt and seam welding of pipes

Welding consumables

Type of steel	Flux	Wire	Backing flux
Mild steel, 490-MPa HT steel	PF-H55E	US-36	RF-1

Note: Redrying conditions of flux; 200~300°Cx1h
(RF-1 must not be dried by heating)

Approvals: PF-H55E / US-36 / RF-1

Number of wires	AB	LR	NV	BV	NK
Two	○	2A, 2YA	II Y(M)	A2M, 2YM	○

○: Subject to satisfactory procedure test by user

Packages

Wire: **US-36**

Dia. (mm)	Type	Weight (kg)
4.8	coil	25
	coil	75
	coil	150
6.4	coil	25
	coil	78
	coil	159

Flux: **PF-H55E**

Mesh size	Type	Weight (kg)
10x48	can	20

Flux: **RF-1**

Mesh size	Type	Weight (kg)
32xD	can	25

FA-B

FAMILIARC™

Principles:

FA-B1 is a flexible backing material suitable for the simplified one-side welding process shown below. The structure of FA-B1 is as shown in the sketch below. It consists of glass fiber tapes for forming a reverse side bead, a solid flux for controlling reverse side bead protrusion, a refractory, a corrugated cardboard pad, a cover film and double-side adhesive tapes. FA-B1 is attached onto the reverse side of the groove with the adhesive tapes and fixed with an aluminum plate and magnetic clamps.

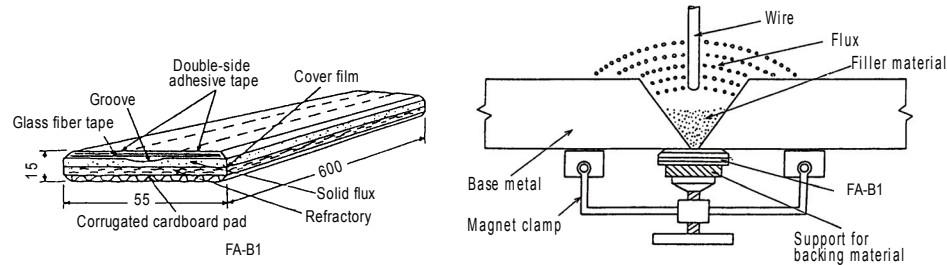

Features:

- (1) FA-B1 features good flexibility to assure smooth contact onto the reverse side of the groove to accommodate much more joint misalignment, distortion and dissimilar-thickness transition of the joint. FA-B1 is also suitable for a joint having a curvature on its reverse side.
- (2) Consistent reverse side beads can be obtained due to a wider tolerance in welding conditions.

Applications:

Curved shell plates, deck plates, bottom plates, tank top plates of ships, steel deck plates of bridges, and other one-side welding applications

Welding consumables

Type of steel	Flux	Wire	Metal powder	Backing material
Mild steel	MF-38	US-36	RR-2	FA-B1
	PF-I52E	US-36	RR-2	FA-B1
490MPa HT steel	MF-38	US-49	RR-2	FA-B1
	PF-I52E	US-36	RR-2	FA-B1

Note: Redrying conditions of flux: **PF-I52E**: 200~300°Cx1h, **MF-38**: 150~350°Cx1h
(**FA-B1** and **RR-2** must not be dried by heating)

Approvals: PF-I52E / US-36 / RR-2 / FA-B1

Number of wires	AB	LR	NV	BV	NK	Others
Single	○	3A, 3YA	III Y	A3YM	KAW53	GL, CR, CCS
Tandem	3*, 3Y*	3A, 3YA	III Y	A3YM	KAW53	GL, CR, CCS

○: Subject to satisfactory procedure test by user

Approvals: MF-38 / US-36 / RR-2 / FA-B1

Number of wires	AB	LR	NV	BV	NK
Single	3*	3A	III M	A3M	KAW3

Packages

Wire: **US-36 / US-49**

Dia. (mm)	Type	Weight (kg)
4.8	coil	25
	coil	75
	coil	150
6.4	coil	25
	coil	78
	coil	159

Flux: **PF-I52E**

Mesh size	Type	Weight (kg)
10x48	can	20

Flux: **MF-38**

Mesh size	Type	Weight (kg)
12x65	can	20

Backing materials: **FA-B1**

Applicable type of joint	Length (mm)	Pieces per carton
Standard joint	600	30
Transition joint	600	25
Mismatch joint	600	30

Electrogas Arc Welding

Principles:

Electrogas arc welding (EGW) is vertical-up butt welding. SEGARC is an automatic vertical welding process suitable for EGW. This process uses SEG-2Z equipment with the combination of a small diameter flux-cored wire, a sliding copper shoe on the front side of a joint, and a fixed backing on the reverse side of a joint.

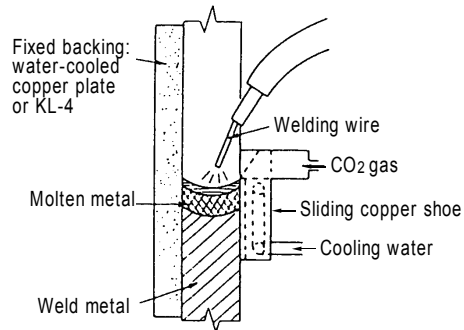

Features:

- (1) High deposition rates (e.g., 180g/min at 380A) provide high welding efficiency.
- (2) Lightweight, compact-size equipment makes it easy to set up.
- (3) Wire extension can be controlled constant against varied welding conditions.
- (4) Welding line can be located either on the left side (Standard) or, by re-assembling, the right side of the tracking rail.
- (4) With the oscillator (Option), one-pass completion welding can be conducted for plates with a thickness of 32 mm max.
- (5) The carriage can be detached at any place of the tracking rail.

Applications:

- (1) Side shells, bulkheads, hoppers of bulk carriers in shipbuilding
- (2) Box girder webs and I-plate girder webs in bridge construction
- (3) Press flame, storage tanks, large diameter pipes, and other vertical welding lines

Welding consumables and equipments

Type of steel	Trade designation	Backing material	Shielding gas	Equipment	Polarity
Mild steel & 490MPa HT steel	DW-S43G	KL-4	CO ₂	SEG-2Z	DC-EP
Mild steel & 490MPa HT steel for low temperature service	DW-S1LG	KL-4	CO ₂	SEG-2Z	DC-EP
550 to 610MPa HT steel	DW-S60G	KL-4	CO ₂	SEG-2Z	DC-EP

Example of chemical composition of weld metal (%)

Trade designation	C	Si	Mn	P	S	Ni	Mo	Ti
DW-S43G	0.08	0.35	1.63	0.014	0.010	0.02	0.17	0.02
DW-S1LG	0.05	0.25	1.60	0.009	0.007	1.40	0.13	0.05
DW-S60G	0.08	0.32	1.67	0.010	0.008	0.71	0.25	0.03

Example of mechanical properties of weld metal

Trade designation	0.2%OS (MPa)	TS (MPa)	EI (%)	IV (J)
DW-S43G	470	600	27	-20°C: 62
DW-S1LG	500	615	25	-60°C: 100
DW-S60G	520	650	26	-20°C: 65

Approvals: DW-S43G (Backing: KL-4)

AB	LR	NV	BV	NK	Others
○	3, 3Y1	ⅢY	AV3, AV3Y	○	GL, CCS, CR, KR

Approvals: DW-S1LG (Backing: KL-4)

AB	LR	NV	NK	Others
○	4Y2, 5Y402	VY, NV2-4L, 4-4L	○	GL

Packages

Dia. (mm)	Type	Weight (kg)
1.6	Spool	20

Horizontal Submerged Arc Welding

Principles:

In horizontal submerged arc welding of butt joints, a welding wire is fed at a certain work angle into a granular flux that is sustained by an endless conveyor tracking along the lower part of a double bevel groove according to welding progress. This welding process was developed to improve welding efficiency to cope with increased storage capacity of cylindrical tanks.

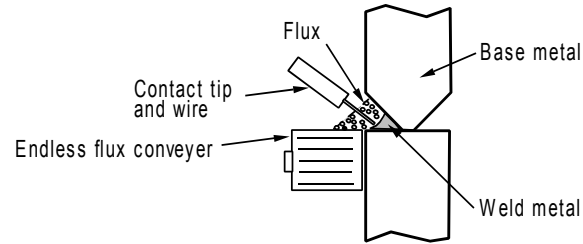

Features:

- (1) Good slag removal and glossy bead appearance
- (2) Good weld metal impact property
- (3) Insensitive to rust and dirt and excellent resistibility to pockmark and porosity
- (4) Good X-ray soundness
- (5) DC polarity is recommended for better fusion and bead shape

Applications:

Horizontal joints of side shells of cylindrical tanks

Welding consumables

Type of steel	Flux	Wire	Polarity
Mild steel & 490MPa HT steel	MF-33H	US-36	DC-EP
550 to 610MPa HT steel	MF-33H	US-49	DC-EP
Mild steel & 490MPa HT steel for low temperature service	MF-33H	US-49A	DC-EP

Note: Redrying conditions of flux; 150~350°Cx1h

Example of chemical composition of weld metal (%) (DC-EP)

Flux	Wire	C	Si	Mn	P	S	Mo
MF-33H	US-36	0.07	0.18	1.48	0.013	0.005	—
MF-33H	US-49	0.05	0.17	1.28	0.010	0.006	0.45
MF-33H	US-49A	0.07	0.24	1.47	0.013	0.009	0.22

Example of mechanical properties of weld metal (DC-EP)

Flux	Wire	0.2%OS (MPa)	TS (MPa)	EI (%)	IV (J)	
MF-33H	US-36	421	512	33	-51°C:114	-20°C:128
MF-33H	US-49	506	585	27	-51°C: 40	-
MF-33H	US-49A	464	560	30	-51°C: 46	-

Packages

Wire: **US-36, US-49, US-49A**

Dia. (mm)	Type	Weight (kg)
3.2	coil	25
	coil	75
4.8	coil	25
	coil	78

Flux: **MF-33H**

Mesh size	Type	Weight (kg)
12x150	can	25

Enclosed Arc Welding

Principles:

With the enclosed arc welding process, welding is continuously progressed in a square groove enclosed by joining components and cooling jigs, using low hydrogen type covered electrodes without removing the slag in the groove during welding.

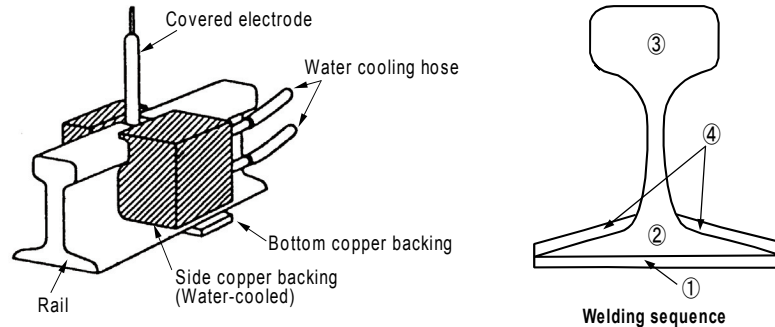

Features:

- (1) Simple, square groove can be used.
- (2) Highly efficient because it is no need to break the arc to remove slag during welding, a large diameter electrode can be used, and narrow groove can be used.

Applications:

Rails for rail roads and crane rails

Welding consumables

Place to be applied	Welding sequence	Trade designation	Polarity	Remarks
Bottom part of a rail	①,②,④	LB-116	AC, DC-EP	Preheating temp: 400~500°C
Top part of a rail	③	LB-80EM	AC, DC-EP	Postweld heating temp: 650~710°Cx 20 min

Note: Redrying conditions: 350~400°Cx1h

Example of chemical composition of all-weld metal (%) (AC)

Trade designation	C	Si	Mn	P	S	Ni	Cr	Mo
LB-116	0.08	0.63	1.50	0.010	0.006	1.83	0.28	0.43
LB-80EM	0.08	0.69	1.93	0.010	0.006	-	0.52	0.38

Example of mechanical properties of all-weld metal (AC)

Trade designation	TS (MPa)	EI (%)
LB-116	830	24
LB-80EM	820	24

Packages of LB-116

Dia. (mm)	Length (mm)	Weight per pack (kg)	Weight per carton (kg)	Weight per piece (g)
2.6	300	2	20	17
3.2	350	5	20	30
4.0	400	5	20	54
5.0	400	5	20	86

Packages of LB-80EM

Dia. (mm)	Length (mm)	Weight per pack (kg)	Weight per carton (kg)	Weight per piece (g)
4.0	450	5	20	58
5.0	450	5	20	90
6.0	450	5	20	131

- **Rules of Ship Classification Societies for Welding Consumables**
- **Welding Consumables Approved by Ship Classification Societies**
- **Redrying Conditions for Welding Consumables**
- **A Guide to Estimating the Consumption of Welding Consumables**
- **Conversions for SAW Flux Sizes**
- **Package Specifications for FCAW, GMAW, and SAW Wires**
- **Conversions for Temperature, Tensile Stress, Impact Energy and Hardness**
- **F-No. Grouping and A-No. Classification of Welding Consumables per ASME IX**
- **AWS Classification System**
- **EN Classification System**

Rules of Ship Classification Societies for Welding Consumables

Note: Omitted here are the rules for one-sided welding consumables, stainless steel welding consumables, and aluminum alloy welding consumables (NK, LR, NV, BV).

■ Covered electrodes for mild steel and high tensile strength steel

Ship class. society	Type of steel	Yield point (MPa)	Tensile strength ⁽¹⁾ (MPa)	El. (%)	Impact value ⁽²⁾			Hydrogen content (ml/100g)
					Grade	Temp. (°C)	J	
NK	Mild steel	≥ 305	400-560 (≥ 400)	≥ 22	KMW1	20	≥ 47 (≥ 34)	•Glycerine method: H15 ≤ 10 H10 ≤ 5 •Mercury and gas chromatography method: H15 ≤ 15 H10 ≤ 10 H5 ≤ 5
	Y32, 36 class steel	≥ 375	490-660 (≥ 490)		KMW2	0		
	Y40 class steel	≥ 400	510-690 (≥ 510)		KMW3	-20		
AB	Mild steel	≥ 305	400-660 (≥ 400)	≥ 22	KMW52	0	≥ 47 (≥ 41)	•Glycerine method: H15 ≤ 10 H10 ≤ 5 •Mercury and gas chromatography method: H15 ≤ 15 H10 ≤ 10 H5 ≤ 5
	Y32, 36 class steel	≥ 375	490-660 (≥ 490)		KMW53	-20		
	Y40 class steel	≥ 400	510-690 (≥ 510)		KMW54	-40		
LR	Mild steel	≥ 305	400-560 (≥ 400)	≥ 22	1Nm	20	≥ 47 (≥ 34)	•Glycerine method: H15 ≤ 10 H10 ≤ 5 •Mercury method: H15 ≤ 15 H10 ≤ 10 H5 ≤ 5
	Y32, 36 class steel	≥ 375	490-660 (≥ 490)		2Nm	0		
	Y40 class steel	≥ 400	510-690 (≥ 510)		3Nm	-20		
NV	Mild steel	≥ 305	400-560 (≥ 400)	≥ 22	1Ym	20	≥ 47 (≥ 41)	•Glycerine method: H15 ≤ 10 H10 ≤ 5 •Mercury method: H15 ≤ 15 H10 ≤ 10 H5 ≤ 5
	Y32, 36 class steel	≥ 375	490-660 (≥ 490)		2Y	0		
	Y40 class steel	≥ 400	510-690 (≥ 510)		3Y	-20		
BV	Mild steel	≥ 305	400-560 (≥ 400)	≥ 22	4Y	-40	≥ 47 (≥ 34)	•Glycerine method: H15 ≤ 10 H10 ≤ 5 •Mercury method: H15 ≤ 15 H10 ≤ 10 H5 ≤ 5
	Y32, 36 class steel	≥ 375	490-660 (≥ 490)		5Y	-60		
	Y40 class steel	≥ 400	510-690 (≥ 510)		2Y40	0		
BV	Mild steel	≥ 305	400-560 (≥ 400)	≥ 22	3Y40	-20	≥ 47 (≥ 41)	•Glycerine method: H15 ≤ 10 H10 ≤ 5 •Mercury method: H15 ≤ 15 H10 ≤ 10 H5 ≤ 5
	Y32, 36 class steel	≥ 375	490-660 (≥ 490)		4Y40	-40		
	Y40 class steel	≥ 400	510-690 (≥ 510)		5Y40	-60		

Note: (1) Tensile strengths in parentheses are requirements in butt welding.
(2) Impact values in parentheses are requirements in vertical butt welding.

■ Wires for mild steel and high tensile strength steel (Semiautomatic gas shielded arc welding)

Ship class. society	Type of steel	Yield point (MPa)	Tensile strength ⁽¹⁾ (MPa)	El. (%)	Impact value ⁽²⁾			
					Grade	Temp. (°C)	J	
NK	Mild steel	≥ 305	400-560 (≥ 400)	≥ 22	KSW1	20	≥ 47 (≥ 34)	
	Y32, 36 class steel	≥ 375	490-660 (≥ 490)		KSW2	0		
					KSW3	-20		
Y40 class steel	≥ 400	510-690 (≥ 510)	KSW51	20	≥ 47 (≥ 41)			
Mild steel	≥ 305	400-660 (≥ 400)	KSW52	0				
			KSW53	-20				
Y32, 36 class steel	≥ 375	490-660 (≥ 490)	KSW54	-40	≥ 47 (≥ 34)			
Y40 class steel	≥ 400	510-690 (≥ 510)	KSW52Y40	0				
			KSW53Y40	-20				
Y40 class steel	≥ 400	510-690 (≥ 510)	KSW54Y40	-40	≥ 47 (≥ 41)			
AB	Mild steel	≥ 305	400-660 (≥ 400)	≥ 22		1SA	20	≥ 47 (≥ 34)
	Y32, 36 class steel	≥ 375	490-660 (≥ 490)			2SA	0	
					3SA	-20		
Y40 class steel	≥ 400	510-690 (≥ 510)	2YSA	0	≥ 47 (≥ 41)			
Mild steel	≥ 305	400-560 (≥ 400)	3YSA	-20				
			4YSA	-40				
Y32, 36 class steel	≥ 375	490-660 (≥ 490)	2Y400SA	0	≥ 47 (≥ 41)			
Y40 class steel	≥ 400	510-690 (≥ 510)	3Y400SA	-20				
			4Y400SA	-40				
LR	Mild steel	≥ 305	400-560 (≥ 400)	≥ 22	1NS	20	≥ 47 (≥ 34)	
	Y32, 36 class steel	≥ 375	490-660 (≥ 490)		2NS	0		
					3NS	-20		
Y40 class steel	≥ 400	510-690 (≥ 510)	1YS	20	≥ 47 (≥ 41)			
Mild steel	≥ 305	400-660 (≥ 400)	2YS	0				
			3YS	-20				
Y32, 36 class steel	≥ 375	490-660 (≥ 490)	4YS	-40	≥ 47 (≥ 41)			
Y40 class steel	≥ 400	510-690 (≥ 510)	2Y40S	0				
			3Y40S	-20				
Y40 class steel	≥ 400	510-690 (≥ 510)	4Y40S	-40	≥ 47 (≥ 34)			
NV	Mild steel	≥ 305	400-560 (≥ 400)	≥ 22		I	20	≥ 47 (≥ 34)
	Y32, 36 class steel	≥ 375	490-660 (≥ 490)			II	0	
					III	-20		
Y40 class steel	≥ 400	510-690 (≥ 510)	IV	20	≥ 47 (≥ 41)			
Mild steel	≥ 305	400-660 (≥ 400)	IIV	0				
			IIIV	-20				
Y32, 36 class steel	≥ 375	490-660 (≥ 490)	IVY	-40	≥ 47 (≥ 41)			
Y40 class steel	≥ 400	510-690 (≥ 510)	VY	-60				
			IIY40	0				
BV	Mild steel	≥ 305	400-560 (≥ 400)	≥ 22	IIIV40	-20	≥ 47 (≥ 41)	
	Y32, 36 class steel	≥ 375	490-660 (≥ 490)		IVY40	-40		
					SA1	20		
Y40 class steel	≥ 400	510-690 (≥ 510)	SA2	0	≥ 47 (≥ 34)			
Mild steel	≥ 305	400-660 (≥ 400)	SA3	-20				
			SA4	-40				
Y32, 36 class steel	≥ 375	490-660 (≥ 490)	SA1Y	20	≥ 47 (≥ 41)			
Y40 class steel	≥ 400	510-690 (≥ 510)	SA2Y	0				
			SA3Y	-20				
BV	Mild steel	≥ 305	400-560 (≥ 400)	≥ 22	SA4Y	-40	≥ 47 (≥ 41)	
	Y32, 36 class steel	≥ 375	490-660 (≥ 490)		SA5Y	-60		
					SA2Y40	0		
Y40 class steel	≥ 400	510-690 (≥ 510)	SA3Y40	-20	≥ 47 (≥ 41)			
Mild steel	≥ 305	400-660 (≥ 400)	SA4Y40	-40				
			SA5Y40	-60				

Note: (1) Tensile strengths in parentheses are requirements in butt welding.
(2) Impact values in parentheses are requirements in vertical butt welding.

Rules of Ship Classification Societies for Welding Consumables

■ Flux-wire combinations and wires for mild steel and high tensile strength steel
(Automatic submerged arc welding and gas shielded arc welding)

Ship class. society	Type of steel	Yield point (MPa)	Tensile strength ⁽¹⁾ (MPa)	El. (%)	Impact value ⁽¹⁾		
					Grade	Temp. (°C)	J
NK	Mild steel	≥ 305	400-560 (≥ 400)	≥ 22	KAW1 KAW2 KAW3	20 0 -20	≥ 34
	Y32, 36 class steel	≥ 375	490-660 (≥ 490)		KAW51 KAW52 KAW53 KAW54	20 0 -20 -40	
	Y40 class steel	≥ 400	510-690 (≥ 510)		KAW52Y40 KAW53Y40 KAW54Y40	0 -20 -40	
AB	Mild steel	≥ 305	400-660 (≥ 400)	≥ 22	1 2 3	20 0 -20	≥ 34
	Y32, 36 class steel	≥ 375	490-660 (≥ 490)		1Y 2Y 3Y 4Y	20 0 -20 -40	
	Y40 class steel	≥ 400	510-690 (≥ 510)		2Y400 3Y400 4Y400	0 -20 -40	
LR	Mild steel	≥ 305	400-560 (≥ 400)	≥ 22	1 2 3	20 0 -20	≥ 34
	Y32, 36 class steel	≥ 375	490-660 (≥ 490)		1Y 2Y 3Y 4Y	20 0 -20 -40	
	Y40 class steel	≥ 400	510-690 (≥ 510)		2Y40 3Y40 4Y40 5Y40	0 -20 -40 -60	
NV	Mild steel	≥ 305	400-560 (≥ 400)	≥ 22	I II III	20 0 -20	≥ 34
	Y32, 36 class steel	≥ 375	490-660 (≥ 490)		IY IIY IIY IVY VY	20 0 -20 -40 -60	
	Y40 class steel	≥ 400	510-690 (≥ 510)		IY40 IIY40 IVY40	0 -20 -40	
BV	Mild steel	≥ 305	400-560 (≥ 400)	≥ 22	A1 A2 A3 A4	20 0 -20 -40	≥ 34
	Y32, 36 class steel	≥ 375	490-660 (≥ 490)		A1Y A2Y A3Y A4Y A5Y	20 0 -20 -40 -60	
	Y40 class steel	≥ 400	510-690 (≥ 510)		A2Y40 A3Y40 A4Y40 A5Y40	0 -20 -40 -60	

Note: (1) Tensile strengths and impact values in parentheses are requirements in butt welding.

■ Wires for mild steel and high tensile strength steel
(Electroslag and electrogas arc welding)

Ship class. society	Type of steel	Yield point (MPa)	Tensile strength ⁽¹⁾ (MPa)	El. (%)	Impact value		
					Grade	Temp. (°C)	J
NK	Mild steel	≥ 305	400-560 (≥ 400)	≥ 22	KEW1 KEW2 KEW3	20 0 -20	≥ 34
	Y32, 36 class steel	≥ 375	490-660 (≥ 490)		KEW51 KEW52 KEW53 KEW54	20 0 -20 -40	
	Y40 class steel	≥ 400	510-690 (≥ 510)		KEW52Y40 KEW53Y40 KEW54Y40	0 -20 -40	
AB	Mild steel	≥ 305	400-660 (≥ 400)	≥ 22	1 2 3	20 0 -20	≥ 34
	Y32, 36 class steel	≥ 375	490-660 (≥ 490)		1Y 2Y 3Y 4Y	20 0 -20 -40	
	Y40 class steel	≥ 400	510-690 (≥ 510)		2Y400 3Y400 4Y400	0 -20 -40	
LR	Mild steel	≥ 305	400-560 (≥ 400)	≥ 22	1 2 3	20 0 -20	≥ 34
	Y32, 36 class steel	≥ 375	490-660 (≥ 490)		1Y 2Y 3Y 4Y	20 0 -20 -40	
	Y40 class steel	≥ 400	510-690 (≥ 510)		2Y40 3Y40 4Y40 5Y40	0 -20 -40 -60	
NV	Mild steel	≥ 305	400-560 (≥ 400)	≥ 22	I II	20 0	≥ 34
	Y32, 36 class steel	≥ 375	490-660 (≥ 490)		IY IIY	20 0	
	Y40 class steel	≥ 400	510-690 (≥ 510)		IIY40	0	
BV	Mild steel	≥ 305	400-560 (≥ 400)	≥ 22	AV1 AV2 AV3	20 0 -20	≥ 34
	Y32, 36 class steel	≥ 375	490-660 (≥ 490)		AV2Y AV3Y AV4Y	0 -20 -40	
	Y40 class steel	≥ 400	510-690 (≥ 510)		AV2Y40 AV3Y40 AV4Y40	0 -20 -40	

Note: (1) Tensile strengths in parentheses are requirements in butt welding.

Rules of Ship Classification Societies for Welding Consumables

Covered electrodes, flux-wire combinations, and wires for thermal refining high tensile strength steel, low temperature steel, and heat resistant steel (SMAW, SAW, FCAW, GMAW)

Note: The welding process designators are omitted for the grades of the ship classification societies other than NK.

Ship class. society	Type of steel	Yield point (MPa)	Tensile strength ⁽¹⁾ (MPa)	El. (%)	Impact value ⁽¹⁾		
					Grade		J
					Temp. (°C)		
NK	Y42 class steel	≥ 420	530-680 (≥ 530)	≥ 20	KMW2Y42, KSW2Y42, KAW2Y42 KMW3Y42, KSW3Y42, KAW3Y42 KMW4Y42, KSW4Y42, KAW4Y42 KMW5Y42, KSW5Y42, KAW5Y42	0 -20 -40 -60	≥ 47
	Y46 class steel	≥ 460	570-720 (≥ 570)	≥ 18	KMW2Y46, KSW2Y46, KAW2Y46 KMW3Y46, KSW3Y46, KAW3Y46 KMW4Y46, KSW4Y46, KAW4Y46 KMW5Y46, KSW5Y46, KAW5Y46	0 -20 -40 -60	≥ 47
	Y50 class steel	≥ 500	610-770 (≥ 610)	≥ 17	KMW2Y50, KSW2Y50, KAW2Y50 KMW3Y50, KSW3Y50, KAW3Y50 KMW4Y50, KSW4Y50, KAW4Y50 KMW5Y50, KSW5Y50, KAW5Y50	0 -20 -40 -60	≥ 50
	Y55 class steel	≥ 550	670-830 (≥ 670)	≥ 16	KMW2Y55, KSW2Y55, KAW2Y55 KMW3Y55, KSW3Y55, KAW3Y55 KMW4Y55, KSW4Y55, KAW4Y55 KMW5Y55, KSW5Y55, KAW5Y55	0 -20 -40 -60	≥ 55
	Y62 class steel	≥ 620	720-890 (≥ 720)		KMW2Y62, KSW2Y62, KAW2Y62 KMW3Y62, KSW3Y62, KAW3Y62 KMW4Y62, KSW4Y62, KAW4Y62 KMW5Y62, KSW5Y62, KAW5Y62	0 -20 -40 -60	≥ 62
	Y69 class steel	≥ 690	770-940 (≥ 770)	≥ 15	KMW2Y69, KSW2Y69, KAW2Y69 KMW3Y69, KSW3Y69, KAW3Y69 KMW4Y69, KSW4Y69, KAW4Y69 KMW5Y69, KSW5Y69, KAW5Y69	0 -20 -40 -60	≥ 69
	Low temperature steel	≥ 305	400-560 (≥ 400)	≥ 22	KMWL1, KSWL1	0	≥ 34 (≥ 27)
					KAWL1	-40	≥ 27
		≥ 345	440-610 (≥ 440)	≥ 21	KMWL2, KSWL2	0	≥ 34 (≥ 27)
					KAWL2	-60	≥ 27
≥ 375	490-660 (≥ 490)	≥ 21	KMWL3, KSWL3	0	≥ 34 (≥ 27)		
			KAWL3	-60	≥ 27		
≥ 410	≥ 660 (≥ 670)	≥ 25	KMWL91, KSWL91, KAWL91	-196	≥ 27		
AB	Y42 class steel	≥ 420	530-680 (≥ 530)	≥ 20	3YQ420 4YQ420 5YQ420	-20 -40 -60	≥ 47
	Y46 class steel	≥ 460	570-720 (≥ 570)		3YQ460 4YQ460 5YQ460	-20 -40 -60	
	Y50 class steel	≥ 500	610-770 (≥ 610)		3YQ500 4YQ500 5YQ500	-20 -40 -60	
	Y55 class steel	≥ 550	670-830 (≥ 670)	≥ 18	3YQ550 4YQ550 5YQ550	-20 -40 -60	≥ 55
	Y62 class steel	≥ 620	720-890 (≥ 720)		3YQ620 4YQ620 5YQ620	-20 -40 -60	≥ 62
	Y69 class steel	≥ 690	770-940 (≥ 770)	≥ 17	3YQ690 4YQ690 5YQ690	-20 -40 -60	≥ 69

Continued

Ship class. society	Type of steel	Yield point (MPa)	Tensile strength ⁽¹⁾ (MPa)	El. (%)	Impact value ⁽¹⁾					
					Grade		J			
					Temp. (°C)					
LR BV	Y42 class steel	≥ 420	530-680	≥ 20	3Y42 4Y42 5Y42	-20 -40 -60	≥ 47 [≥ 41] ⁽²⁾			
	Y46 class steel	≥ 460	570-720		3Y46 4Y46 5Y46	-20 -40 -60	≥ 47			
	Y50 class steel	≥ 500	610-770		3Y50 4Y50 5Y50	-20 -40 -60	≥ 50			
	Y55 class steel	≥ 550	670-830	≥ 18	3Y55 4Y55 5Y55	-20 -40 -60	≥ 55			
	Y62 class steel	≥ 620	720-890		3Y62 4Y62 5Y62	-20 -40 -60	≥ 62			
	Y69 class steel	≥ 690	770-940	≥ 17	3Y69 4Y69 5Y69	-20 -40 -60	≥ 69			
	Low temperature steel	LR BV	≥ 375	≥ 460 (≥ 490)	≥ 22	1.5Ni	-80	≥ 34 (≥ 27)		
						N15	-100			
						3.5Ni	-120			
						N35	-196			
5Ni						-				
N50						-				
9Ni						-				
NV	Y42 class steel	≥ 420	530-680	≥ 20	3Y42/IIIY42 4Y42/IVY42 5Y42/VY42	-20 -40 -60	≥ 47			
	Y46 class steel	≥ 460	570-720		3Y46/IIIY46 4Y46/IVY46 5Y46/VY46	-20 -40 -60				
	Y50 class steel	≥ 500	610-770		3Y50/IIIY50 4Y50/IVY50 5Y50/VY50	-20 -40 -60		≥ 50		
	Y55 class steel	≥ 550	670-830	≥ 18	3Y55/IIIY55 4Y55/IVY55 5Y55/VY55	-20 -40 -60	≥ 55			
	Y62 class steel	≥ 620	720-890		3Y62/IIIY62 4Y62/IVY62 5Y62/VY62	-20 -40 -60	≥ 62			
	Y69 class steel	≥ 690	770-940	≥ 17	3Y69/IIIY69 4Y69/IVY69 5Y69/VY69	-20 -40 -60	≥ 69			
	Low temperature steel ⁽⁴⁾	≥ 305	400-560 (≥ 400)	≥ 22	5V	NV2-4 NV2-4L	-55 -60	≥ 41 ≥ 34		
					5Y/VY	NV4-4 NV4-4L	-55 -60	≥ 41 ≥ 34		
					≥ 375	490-660 (≥ 490)	≥ 25	NV1.5Ni	-95	≥ 34
					≥ 345	≥ 440		NV3.5Ni	-115	
≥ 390					≥ 570	NV5Ni		-145		
≥ 490					≥ 640	NV9Ni	-196			
Heat resistant steel	≥ 305	≥ 440	≥ 18	NV0.3Mo	-	-				
				NV1Cr0.5Mo	-	-				
				NV2.25Cr1Mo	-	-				

Note: (1) Tensile strengths and impact values in parentheses are requirements in butt welding.

(2) Impact value in bracket is requirement in automatic 2-layer welding.

Welding Consumables Approved by Ship Classification Societies

Notes on usage

The ship classification approvals of welding consumables shown below are those renewed as of December 25, 2007. They may be cancelled, added, or changed and may not necessarily be applied to all the welding consumables produced at the production plants (Ibaraki Plant, Saijo Plant, Fukuchiyama Branch, and Fujisawa Branch) of Kobe Steel. Therefore, please contact with the International Operations Dept. of the Welding Company of Kobe Steel when you need the ship classification approval of a particular welding consumable to be used. These tables abbreviate the names of ship classification societies and some designations to those noted in the following. As regards "Grade," refer to the rules of ship classification societies for welding consumables, which are listed at page 328.

■ Covered electrodes for mild steel and high tensile strength steel

Trade designation	AB			LR		NV	
	Grade	AP	F & HF	Grade	WP	Grade	WP
B-14	3	≦5.0	≦8.0	3m	F, V, O	3	F, V, O
B-17	3	≦5.0	≦8.0	3m	F, V, O	3	F, V, O
RB-26	2	≦5.0	-	2m	F, V, O	-	-
LB-26	3H15	≦5.0	≦8.0	3m, 3Ym(H15)	F, V, O	3YH10	F, V, O
LB-52	3H10,3Y,3Y400	≦5.0	≦6.0	3m, 3Ym(H15)	F, V, O	3YH10	F, V, O
LB-52A	-	-	-	-	-	-	-
LB-52U	3H10, 3Y	≦5.0	-	3m, 3Ym(H15)	F, V, O	3YH10	F, V, O
LB-52T	3H10, 3Y	≦5.0	-	3m, 3Ym(H15)	F, V, O	3YH10	F, V, O
LB-52-18	3H10, 3Y	≦4.0	≦6.0	3m, 3Ym(H15)	F, V, O	3YH10	F, V, O
LB-62	3YQ500(H10)	≦4.0	≦6.0	3m, 3Ym(H15)	F, V, O	3YH10	F, V, O
LB-62U	3YQ500(H10)	≦4.0	-	-	-	-	-
LB-62UL	-	-	-	-	-	-	-
LB-67L	5YQ500 H5	≦4.0	≦5.0	-	-	-	-
LB-80UL	-	-	-	-	-	-	-
LB-88LT	-	-	-	-	-	5Y69H5	F, V, O
LB-106	MG(E10016-G)	≦6.0	-	-	-	-	-
LB-70L	4YQ620 H5	≦4.0	≦5.0	-	-	4Y62H5	F, V, O
LB-116	MG(E11016-G)	≦4.0	≦6.0	-	-	4Y69H5	F, V, O
LB-80L	5YQ690 H5	≦4.0	≦5.0	-	-	5Y69H5	F, V, O
LT-B50	3, 3Y*	-	≦8.0	3m, 3Ym, 3YG	F	3, MG	F
LT-B52A	3H10, 3Y	≦4.5	≦8.0	3G, 3YG(H15)	F, V, O	3YH15	F, V, O
Z-44	3	≦6.0	-	3m	F, V, O	3	F, V, O

Note: (1) The maximum electrode diameter (mm) for all-position welding is indicated outside the paren-

[Ship classification societies]

AB: American Bureau of Shipping LR: Lloyd's Register of Shipping NV: Det Norske Veritas

BV: Bureau Veritas NK: Nippon Kaiji Kyokai CR: Central Research of Ships S. A.

GL: Germanischer Lloyd KR: Korean Register of Shipping CCS: China Classification Society

[Welding positions]

F: Flat position V: Vertical position VD: Vertical down O: Overhead; H: Horizontal

[Other abbreviations]

MG: Maker guarantee MED: Maximum electrode diameter

BV		NK			Others
Grade	WP	Grade	MED ⁽¹⁾	F & HF	
3	F, V, O	KMW3	5(8)	F, V, O	CR, GL
3	F, V, O	KMW3	5(8)	F, V, O	CR, GL
-	-	KMW2	5	F, V, O	
3, 3YH	F, V, O	KMW3H15	5(8)	F, V, O	CR
3, 3Y	F, V, O	KMW53H10	5(8)	F, V, O	
-	-	KMW53HH	5(6)	F, V, O	
3, 3YHH	F, V, O	KMW53H10	5	F, V, O	CCS
3, 3YHH	F, V, O	KMW53H10	5	F, V, O	CR
-	-	KMW53HH	4(6)	F, V, O	
3, 3YHH	F, V, O	KMW3Y50H10	5(6)	F, V, O	CR
-	-	-	-	-	
-	-	-	-	-	CCS
-	-	-	-	-	
-	-	KMW3Y69H5	4(5)	F, V, O	CCS
-	-	-	-	-	
-	-	KMW3Y62H5	5(6)	F, V, O	CR
-	-	-	-	-	
-	-	MG(E11016-G)	4(5)	F, V, O	
-	-	-	-	-	
3, 3Y	F	KMW53	8	F, H	CR, GL
3, 3YHH	F, V, O	KMW53H	4.5(8)	F, V, O	
-	-	KMW3	5	F, V, O	

thesis while that for flat welding is indicated inside the parenthesis.

Welding Consumables Approved by Ship Classification Societies

■ Covered electrodes for low temperature steel

Trade designation	AB			LR		NV	
	Grade	AP	F & HF	Grade	WP	Grade	WP
LB-7018-1	4Y400(H10)	≤4.0	-	4Y40mH10	F, V, O	-	-
LB-52NS	3H10, 3Y, MG	≤5.0	≤6.0	5Y40m(H15)	F, V, O	5YH10 NV2-4(L), 4-4(L)	F, V, O
NB-1SJ	-	-	-	5Y40m(H15)	F, V, O	5YH10 NV2-4L, 4-4L	F, V, O
LB-62L	5YQ500H10	≤5.0	-	-	-	-	-
NI-C70S	-	-	-	-	-	-	-
NI-C1S	-	-	-	-	-	-	-

Note: (1) The maximum electrode diameter (mm) for all-position welding is indicated outside the paren-

■ Covered electrodes for heat-resistant low-alloy steel

Trade designation	AB			LR		NV	
	Grade	AP	F & HF	Grade	WP	Grade	WP
CM-A96	MG(E8016-B2)	≤4.0	≤6.0	MG(E8016-B2)	F, V, O	H10,NV1Cr0.5Mo	F, V, O
CM-A96MB	-	-	-	-	-	-	-
CM-B98	-	-	-	MG(E8016-B2)	F, V, O	-	-
CM-A106	MG(E9016-B3)	≤6.0	-	MG(E9016-B3)	F, V, O	H10, NV2.25Cr1Mo	F, V, O
CM-A106N	-	-	-	-	-	-	-

Note: (1) The maximum electrode diameter (mm) for all-position welding is indicated outside the paren-

■ Covered electrodes for stainless steel

Trade designation	AB			LR		NV	
	Grade	AP	F & HF	Grade	WP	Grade	WP
NC-38	MG(E308-16)	≤5.0	-	-	-	308	F, V, O
NC-38L	-	-	-	304Lm(Chem.)	F, V, O	-	-
NC-38LT	-	-	-	304Lm(Cry.)	F, V, O	308L	F, V, O
NC-39	MG(E309-16)	≤4.0	≤6.0	SS/CMnm(Chem.)	F, V, O	309, MG	F, V, O
NC-39L	-	-	-	-	-	309L, MG	F, V, O
NC-39MoL	MG	≤4.0	≤5.0	-	-	-	-
NC-36	-	-	-	-	-	-	-
NC-36L	MG(E316L-16)	≤4.0	≤5.0	316Lm(Chem.)	F, V, O	316L, MG	F, V, O

Note: (1) The maximum electrode diameter (mm) for all-position welding is indicated outside the paren-

BV		NK			Others
Grade	WP	Grade	MED ⁽¹⁾	F & HF	
-	-	-	-	-	
4Y40MHH, MG	F, V, O	KMWL3HH	5(6)	F, V, O	
4Y40MHH, MG	F, V, O	KMW5Y42H10	5	F, V, O	
-	-	-	-	-	
-	-	KMWL91	4(5)	F, V, O	
-	-	KMWL92	4(5)	F, V, O	

thesis while that for flat welding is indicated inside the parenthesis.

BV		NK			Others
Grade	WP	Grade	MED ⁽¹⁾	F & HF	
MG(E8016-B2)	F, V, O	MG(E8016-B2)	4(6)	F, V, O	
MG(E8016-B2)	F, V, O	-	-	-	
-	-	-	-	-	
MG(E9016-B3)	F, V, O	MG(E9016-B3)	4(6)	F, V, O	
MG(E9016-B3)	F, V, O	-	-	-	

thesis while that for flat welding is indicated inside the parenthesis.

BV		NK			Others
Grade	WP	Grade	MED ⁽¹⁾	F & HF	
-	-	KD308	4(5)	F, V, O	
308L	F, V, O	KD308L	4(6)	F, V, O	GL
-	-	KD308L	4	F, V, O	
MG(E309-16)	F, V, O	KD309	4(5)	F, V, O	CCS, GL
MG(E309L-16)	F, V, O	KD309L	4	F, V, O	
-	-	KD309Mo	4(5)	F, V, O	
-	-	KD316	4(6)	F, V, O	
MG(E316L-16)	F, V, O	KD316L	5	F, V, O	GL

thesis while that for flat welding is indicated inside the parenthesis.

Welding Consumables Approved by Ship Classification Societies

■ Flux-cored wires for gas shielded arc welding of mild steel and high tensile strength steel ⁽¹⁾

Trade designation	AB	LR
DW-100/CO ₂	2SA, 2Y400SA(H10)	2S, 2YS(H10), 2M, 2YM(H10)
DW-50/CO ₂	3SA, 3YSA(H5)	3S, 3YS(H5)
DW-50/Ar-CO ₂	3SA, 3YSA(H5)	3S, 3YS(H5)
DW-100V/CO ₂	2SA, 2YSA	2S, 2YS(H10)
DW-100E/CO ₂	3SA, 3Y400SA(H10)	3S, 3YS(H10)
DW-200/CO ₂	3SA, 3YSA	3S, 3YS(H10)
DW-A50/Ar-CO ₂	3SA, 3YSA(H5)	3S, 3YS(H5)
DW-A51B/Ar-CO ₂	-	3YS(H5)
MX-100/CO ₂	2SA, 2YSA	2S, 2YS(H10)
MX-100T/CO ₂	3SA, 3YSA(H5)	3S, 3YS(H5)
MX-100T/Ar-CO ₂	-	3S, 3YS(H5)
MX-200/CO ₂	2SA, 2Y400SA(H5)	2S, 2YS(H5)
MX-200E/CO ₂	4Y400SA(H5)	4Y40S(H5)
MX-200H(×2)/CO ₂	3SA, 3YSA	3M, 3YM(H5)
MX-A100/Ar-CO ₂	-	3S, 4Y(H5)

Note: (1) The designators put before or after a numeral signify the following. G: the wire uses a shield-

■ Flux-cored wires for gas shielded arc welding of low temperature steel ⁽¹⁾

Trade designation	AB	LR
DW-55E/CO ₂	3SA, 3Y400SA(H5)	4Y40S(H5)
DW-A55E/Ar-CO ₂	4Y400SA(H5)	4Y40S(H5)
DW-55L/CO ₂	3SA, 4Y400SA, MG	5Y40S(H15)
DW-55LF/CO ₂	-	5Y40S(H15)
DW-55LSR/CO ₂	5YQ420SA(H5), 4Y400SA(H5)	5Y42S, 5Y42srS(H10), MG
DW-A55L/Ar-CO ₂	3SA, 3YSA, MG	5Y46S(H5)
DW-A55LSR/Ar-CO ₂	5YQ420SA(H5)	5Y42S(H5)
DW-A55ESR/Ar-CO ₂	4Y400SA(H5)	-
DW-A81Ni1/ Ar-CO ₂	5YQ420SA(H5), 4Y400SA(H5)	5Y42S(H5)
MX-55LF/CO ₂	3YSA, MG	5Y40S(H5)
MX-A55T/Ar-CO ₂	-	5Y40S(H5)

Note: (1) The designators put before or after a numeral signify the following. G: the wire uses a shield-

NV	BV	NK	Others
II YMS(H10)	SA2MHH, SA2YMHH	KSW52Y40G(C)H10	CR, GL, KR, CCS
III YMS(H5)	-	KSW53G(C)	GL
III YMS(H5)	-	-	GL
II YMS	SA2YM	KSW52G(C)	GL
III YMS	SA3, 3YM	KSW53G	GL, CCS
III YMS	SA3YM	KSW53G(C)	
III YMS(H5), MG	SA3YMHHH	KSW52G(M2)	GL
III YMS(H5)	SA3YM(HHH)	-	GL
II YMS	SA2YM	KSW52G(C)	CR, GL
III YMS(H5)	SA3YM(HHH)	-	CR, GL
III YMS(H5)	SA3YM(HHH)	-	GL
II YMS(H5)	SA2YMHHH	KSW52Y40G(C)H5	CR, GL, KR, CCS
IV Y40MS(H5)	SA4Y40MH5	KSW54Y40G(C)H5	GL
III YM	A3YM	KSW53G(C)	CR, KR, CCS
IV YMS(H5)	SA4YMHHH	-	GL

ing gas; S or SA: semiautomatic welding; M or MS: multiple-pass welding.

NV	BV	NK	Others
III YMS(H5)	SA3, SA3YMHHH	KSW54Y40G(C)H5	CR, GL
IV YMS(H5)	SA3YMHHH	-	GL
V YMS(H10), NV2-4, 4-4	SA3YM(HH), MG	KSWL3G(C)	GL, KR, CCS
V YMS(H15), NV2-4L, 4-4L	-	KSWL3G(C)	
V 42MS(H10), MG, NV2-4L, 4-4L	SA4Y40MHH, MG	KSW5Y42G(C)H10, MG	
V Y46MS(H5), NV2-4, 4-4	-	-	
V Y42MS(H5), NV2-4L, 4-4L	-	-	
-	-	-	
V Y42MS(H5), NV2-4L, 4-4L	-	-	
V YMS, NV2-4L, 4-4L	SA3YM, MG	KSWL3G(C), 54G(C)	
V YMS(H5), NV2-4, 4-4	SA3YM(HHH), MG	-	

ing gas; S or SA: semiautomatic welding; M or MS: multiple-pass welding.

Welding Consumables Approved by Ship Classification Societies

Flux-cored wires for gas shielded arc welding of stainless steel ⁽¹⁾

Trade designation	AB	LR
DW-308/CO ₂	MG	-
DW-308L/CO ₂	MG	304LS(Chem.Cry.)
DW-308L/Ar-CO ₂	-	-
DW-308LP/CO ₂	MG	304LMS(Chem.Cry.)
DW-308LT/CO ₂	-	304LS(Chem.Cry.)
DW-309L/CO ₂	MG	SS/CMnS(Chem.)
DW-309L/Ar-CO ₂	-	SS/CMnS(Chem.)
DW-309LP/CO ₂	-	SS/CMnMS(Chem.Cry.)
DW-309LP/Ar-CO ₂	-	SS/CMnS(Chem.)
DW-309MoL/CO ₂	MG	SS/CMnS(Chem.)
DW-309MoL/Ar-CO ₂	-	-
DW-316L/CO ₂	MG	316LS(Chem.)
DW-316L/Ar-CO ₂	-	316LS(Chem.)
DW-316LP/CO ₂	-	-
DW-316LP/Ar-CO ₂	-	316LS(Chem.)
DW-317L/CO ₂	-	MG

Note: (1) The designators put before or after a numeral signify the following. G: the wire uses a shield-

Solid wires for gas shielded arc welding of mild steel and high tensile strength steel ⁽¹⁾

Trade designation	AB	LR
MG-50/CO ₂	3SA, 3YSA	3S, 3YS, H15
MG-50T/CO ₂	3SA, 3YSA	3S, 3YS, H15
MG-60/CO ₂	-	-
MG-S80/Ar-CO ₂	MG(ER110S-G)	-
MIX-50/Ar-CO ₂	3SA, 3YSA	-
MIX-50S/Ar-CO ₂	3SA, 3YSA	3S, 3YS(H15)
TG-S50/Ar	3*, 3Y*	3Ym, H15

Note: (1) The designators put before or after a numeral signify the following. G: the wire uses a shield-

NV	BV	NK	Others
-	-	KW308G	
308LMS	-	KW308LG(C)	GL
308LMS	-	-	
308L	308LBT	KW308LG(C)	KR
308LMS	-	MG	
309LMS	MG	KW309LG(C) (base on KW309)	GL
-	-	-	
309L	309L	KW309LG(C)	
309L	309L	-	
309MoLMS	MG	MG	
309MoLMS	-	-	
316MLS	MG	KW316LG(C)	GL
316MLS	-	-	
316L	-	KW316LG(C)	
316L	-	-	
317LMS	MG	MG	

ing gas; S or SA: semiautomatic welding; M or MS: multiple-pass welding.

NV	BV	NK	Others
III YMS	SA3M, 3YM	KSW53G	CR, GL, KR
III YMS	SA3M, 3YM	KSW53G	CR, KR
III Y46MS, MG	-	KSW3Y50G(C)H15	
IV Y69MS	-	MG	GL
-	-	KSW53G	
III YMS	-	KSW53G	GL
III YM	SA3YM	KSW53G	CCS

ing gas; S or SA: semiautomatic welding; M or MS: multiple-pass welding.

Welding Consumables Approved by Ship Classification Societies

■ Solid wires for gas shielded arc welding of low temperature steel ⁽¹⁾

Trade designation	AB	LR
MG-S50LT/Ar-CO ₂	3YSA, MG	5Y40S(H15)
TG-S1N/Ar	4YSA, MG	MG
TG-S709S/Ar	-	-

Note: (1) The designators put before or after a numeral signify the following. G: the wire uses a shield-

■ Solid wires for gas shielded arc welding of heat-resistant low-alloy steel ⁽¹⁾

Trade designation	AB	LR
MG-S1CM/Ar-CO ₂	MG(ER80S-G)	MG(ER80S-G)
TG-SM/Ar	MG(ER80S-G)	-
TG-S1CM/Ar	MG	MG(ER80S-G)
TG-S2CM/Ar	MG	-

Note: (1) The designators put before or after a numeral signify the following. G: the wire uses a shield-

■ Solid wires for gas shielded arc welding of stainless steel ⁽¹⁾

Trade designation	AB	LR
TG-S308/Ar	MG(ER308)	-
TG-S308L/Ar	MG(ER308L)	MG(Y308L)
TG-S309/Ar	-	-
TG-S316L/Ar	MG(ER316L)	MG(Y316L)
TG-S317L/Ar	-	317Lm(Chem.)
TG-S347/Ar	-	-

Note: (1) The designators put before or after a numeral signify the following. G: the wire uses a shield-

NV	BV	NK	Others
V YMS, NV2-4(L), 4-4(L)	-	KSWL3G	
V YM, NV4-4L	4YM, MG	KSWL2G	GL
-	-	KSWL92G(I)	GL

ing gas; S or SA: semiautomatic welding; M or MS: multiple-pass welding.

NV	BV	NK	Others
-	MG(ER80S-G)	-	
-	-	-	
MG	MG(ER80S-G)	MG	KR
MG	MG(ER90S-G)	MG	KR

ing gas; S or SA: semiautomatic welding; M or MS: multiple-pass welding.

NV	BV	NK	Others
308MS	-	KY308	
308LMS	308LBT	KY308L	CCS, GL
309MS	-	KY309	GL
316LMS	316LBT	KY316L	CCS, GL
-	-	-	
-	-	KY347	

ing gas; S or SA: semiautomatic welding; M or MS: multiple-pass welding.

Welding Consumables Approved by Ship Classification Societies

■ Flux/wire combinations for submerged arc welding [Multi-pass and double-sided two pass welding] ⁽¹⁾

Trade designation	AB	LR
US-36/G-60	1T	1T
US-36/G-80	2M	2M
US-36/MF-38	2T, 2YT, 3M, 3YM	2T, 2YT, 3YM
US-36/MF-53	2T, 2YT	2M, 2YM
US-36(×2)/MF-53	○	-
US-36/MF-300	2T, 2YT, 3M, 3YM	2T, 2YT, 3YM
US-36/PF-H55E	3TM, 3YTM, 3Y400TM	3T, 3YM, 3YT
US-36(×2)/PF-H55E	○	3T, 3YM, 3YT
US-36/PF-H55LT	3M, 3YM, MG	5Y40M(H5)
US-36(×2)/PF-H55LT	4YM, MG	-
US-40/MF-38	MG	-
US-43/PF-H45	3TM	3M, 3T
US-43(×2)/PF-H45	○	3M, 3T
US-43/PF-I50	3TM, 3YTM	3T, 3YM, 3YT
US-49/MF-38	3YTM	3T, 3YM, 3YT
US-36J/PF-H55AS	5Y400(H5)	5Y40MH5
US-80LT/PF-H80AS	4YQ690	-
US-80LT/PF-H80AK	-	-
US-709S/PF-N4	-	-

Note: (1) The designators put after a numeral signify the following: T: Double-sided two pass welding

NV	BV	NK	Others
IT	A1T	KAW1TM	CR
IIIYM	A3M	KAW2M	KR
IIYT, IIIYM	A2, 2YT, 3, 3YM	KAW52T, 53M	CR, GL, KR
IIIY	-	KAW52	
-	-	○	
IIYT, IIIYM	-	-	GL
IIIYTM	A3YTM	KAW53Y40TM	CR, GL
-	A3, A3YT	○	GL
VYM, NV2-4, 4-4	A4YM, MG	KAWL3M	
VYM	-	-	
-	-	KAW3Y50MH10	
IIITM	A3TM	KAW3TM	CR, GL
-	-	○	
-	-	KAW53TM	
IIIYTM	A3YTM	KAW3Y46TMH10	CCS
-	-	-	
-	-	-	
VY69M	-	-	
-	-	KAWL92M	

M: Multi-pass welding.

Redrying Conditions for Welding Consumables

Covered electrodes

Applicable type of metal	Type of covering	Trade designation	Guideline of moisture content that needs redrying (%) ⁽¹⁾	Redrying temperature (°C)
Mild steel	Ilmenite	B-10,B-14, B-17	3	70-100
	Lime titania	Z-44	2	70-100
	High titanium oxide	RB-26,B-33	3	70-100
	Low hydrogen	LB-26,LB-47,LB-52U	0.5	300-350
	Iron powder titania	KOBE-7024	2	70-100
Weather proof steel	Low hydrogen	LB-W52,	0.5	325-375
		LB-W52B,LB-W588,LB-W62G	0.5	350-400
High tensile strength steel or low temperature steel	Lime titania	LT-B50	2	70-100
	Low hydrogen	LB-52,LB-52-18,LB-52T,LB-76,LT-B52A,LB-52RC	0.5	300-350
		LB-52A,LB-7018-1,LB-52LT-18, LB-57,LB-62,LB-62D,LB-62L, LB-62U, LB-65L,LB-67L,LB-106, LB-70L, LB-116, LB-80L, LB-M52,LB-78VS,LB-88VS, LB-98VS,LB-80EM	0.3-0.5	350-400
		LB-62UL,LB-80UL,LB-88LT	-	350-430
Low temperature steel or heat-resistant low-alloy steel	High titanium oxide	CM-B83	3	70-100
	Low hydrogen	LB-52NS,NB-1SJ,NB-3J	0.5	350-400
		BL-96,BL-106,CM-2CW,CM-5, CM-9,CM-95B9,CM-96B9, CM-9Cb,CM-A76,CM-A96, CM-A96MB,CM-A96MBD, CM-A106,CM-A106N, CM-A106ND,CM-A106H, CM-A106HD,CM-B95,CM-B98, CM-B105,CM-B108,CR-12S	0.5	325-375

Redrying time (min.)	Max. allowable redrying time (h) ⁽²⁾	Max. allowable cycles of redrying (cycle) ⁽²⁾	Holding temperature (°C)	Max. holding time (h) ⁽²⁾	Min. time to reach guideline of moisture content after redrying (h) ⁽³⁾
30-60	24	5	-	-	8
30-60	24	5	-	-	8
30-60	24	5	-	-	8
30-60	24	3	100-150	72	4
30-60	24	5	-	-	8
60	24	3	100-150	72	4
60	24	3	100-150	72	4
30-60	24	5	-	-	8
30-60	24	3	100-150	72	4
60	24	3	100-150	72	4
60	12	3	100-150	72	4
30-60	24	5	-	-	8
60	24	3	100-150	72	4
60	24	3	100-150	72	4

Note: (1) Drying is needed if the moisture content (weight loss of the covering at 110°C) exceeds this guideline to recover the usability and weldability of welding consumables.

(2) Longer periods or more cycles of drying than indicated above may cause permanent damage of welding consumables. Welding consumables dried or held in the conditions indicated above should be confirmed that they have no change in color, no cracking in the covering, no covering detachment, and other damages before use, and that no abnormal performance is recognized during welding.

(3) Under the atmosphere of 30°C-80% relative humidity.

Redrying Conditions for Welding Consumables

Covered electrodes

Applicable type of metal	Type of covering	Trade designation	Guideline of moisture content that needs redrying (%) ⁽¹⁾	Redrying temperature (°C)
Cr-Ni stainless steel	Lime titania	NC-×××	1	150-200
Cr stainless steel	Lime titania	CR-40,CR-43	0.5	300-350
	Lime	CR-40Cb,CR-43Cb,CR-43CbS	0.5	300-350
Hardfacing	High titanium oxide	HF-240,HF-330	3	70-100
	Lime	HF-12,HF-13,HF-30,HF-260, HF-350,HF-450,HF-500,HF-600, HF-650,HF-700,HF-800K	0.5	300-350
		HF-11,HF-16	1	150-200
	Graphite	HF-950	1	150-200
		HF-1000	2	70-100
Cast iron	Lime	CI-A3,CI-A5	0.5	300-350
	Graphite	CI-A1,CI-A2	1.5	70-100
Ni alloy	Lime titania	ME-L34	1	150-200
	Lime	NI-C1S,NI-C70A,NI-C70E, NI-C70S,NI-C625,NI-C703D	1	200-250

Redrying time (min.)	Max. allowable redrying time (h) ⁽²⁾	Max. allowable cycles of redrying (cycle) ⁽²⁾	Holding temperature (°C)	Max. holding time (h) ⁽²⁾	Min. time to reach guideline of moisture content after redrying (h) ⁽³⁾
30-60	24	3	100-150	72	4
30-60	24	3	100-150	72	4
30-60	24	3	100-150	72	4
30-60	24	5	-	-	8
30-60	24	3	100-150	72	4
30-60	24	3	100-150	72	4
30-60	24	3	100-150	72	4
30-60	24	5	-	-	8
30-60	24	3	100-150	72	4
30-60	24	5	-	-	8
30-60	24	3	100-150	72	4
30-60	24	3	100-150	72	4

Note: (1) Drying is needed if the moisture content (weight loss of the covering at 110°C) exceeds this guideline to recover the usability and weldability of welding consumables.

(2) Longer periods or more cycles of drying than indicated here may cause permanent damage of welding consumables. Welding consumables dried or held in the conditions indicated above should be confirmed that they have no change in color, no cracking in the covering, no covering detachment, and other damages before use, and that no abnormal performance is recognized during welding.

(3) Under the atmosphere of 30°C-80% relative humidity.

Redrying Conditions for Welding Consumables

Fluxes for submerged arc welding

Applicable type of metal	Type of flux	Trade designation	Redrying temperature (°C)	Redrying time (min.)
Mild steel, Weather proof steel, or High tensile strength steel (490MPa)	Fused type	G-50,G-60,G-80,MF-33H, MF-38,MF-38A,MF44,MF-53, MF-63,MF-300	150-350	60
	Bonded type	PF-H45,PF-H55E,PF-I50, PF-I52E,PF-I55E,PF-H55AS	200-300	60
High tensile strength steel (590-780MPa)	Fused type	MF-33H,MF-38,MF-38A, MF-63	150-350	60
	Bonded type	PF-H80AK,PF-H80AS	250-350	60
Low temperature steel or Heat-resistant low-alloy steel	Fused type	G-80,MF-27,MF-29A,MF-33H, MF-38	150-350	60
	Bonded type	PF-H203,PF-H55LT, PF-200, PF-200S,PF-500,PF-200D, PF-500D,PF-90B9	200-300	60
Stainless steel	Bonded type	PF-S1,PF-S1M,PF-S1LT, PF-S4M	200-300	60
Hardfacing	Fused type	G-50,MF-30	150-350	60
9%Ni steel	Bonded type	PF-N3,PF-N4,	200-300	60

Note: (1) Longer periods or more cycles of drying than indicated here may cause permanent damage of welding consumables. Welding consumables dried or held in the conditions indicated above should be confirmed that they have no change in color and other damages before use, and that no abnormal performance is recognized during welding.

(2) Under the atmosphere of 30°C-80% relative humidity.

Max. allowable redrying time (h) ⁽¹⁾	Max. allowable cycles of redrying (cycle) ⁽¹⁾	Holding temperature (°C)	Max. holding time (h) ⁽¹⁾	Min. time to reach guideline of moisture content after redrying (h) ⁽²⁾
24	5	100-150	72	8
24	5	100-150	72	8
24	5	100-150	72	8
24	5	100-150	72	8
24	5	100-150	72	8
24	5	100-150	72	8
24	5	100-150	72	8
24	5	100-150	72	8

A Guide to Estimating the Consumption of Welding Consumables

Figure 1 shows the calculated consumption of welding consumables as a function of plate thickness, welding process, groove angle, and root opening for butt joints. Figure 2 shows the calculated consumption of welding consumables as a function of fillet size, welding process, and reinforcement size. These diagrams were developed using the calculations obtained by the following equation for both groove and fillet welding joints under the prerequisites given below.

$$C = [(A_1 + A_2) \times L \times G / E] \times 1 / 10$$

where C: Consumption of welding consumables (kg); A_1 : Area of Section A_1 weld metal (mm^2) (See Fig. 3); A_2 : Area of Section A_2 reinforcement (mm^2) (See Fig. 3); L: Weld length (m); G: Specific gravity of weld metal (7.85 g/cm^3); E: Deposition Efficiency (%) — SMAW covered electrodes: 55%; GMAW solid/metal-cored wires: 95%; FCAW flux-cored wires: 90%; SAW solid wires: 100%.

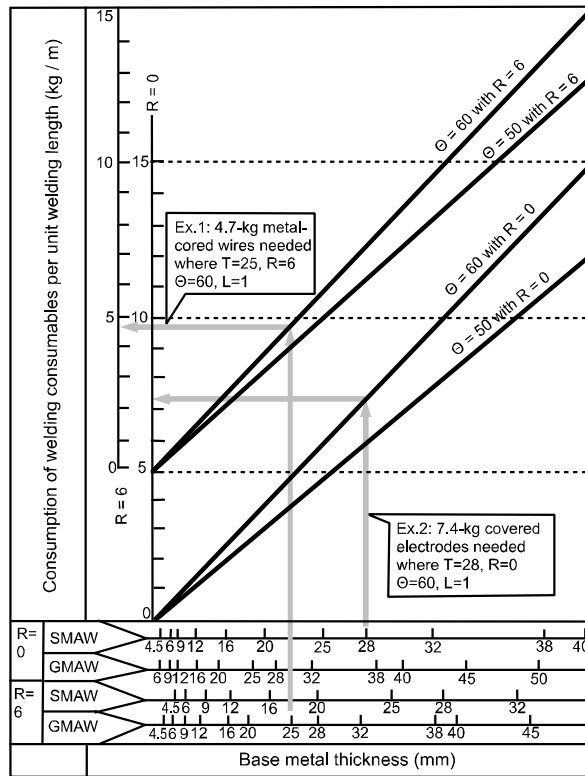

Fig. 1 Consumption of covered electrodes in SMAW and solid/metal-cored wires in GMAW of butt joints

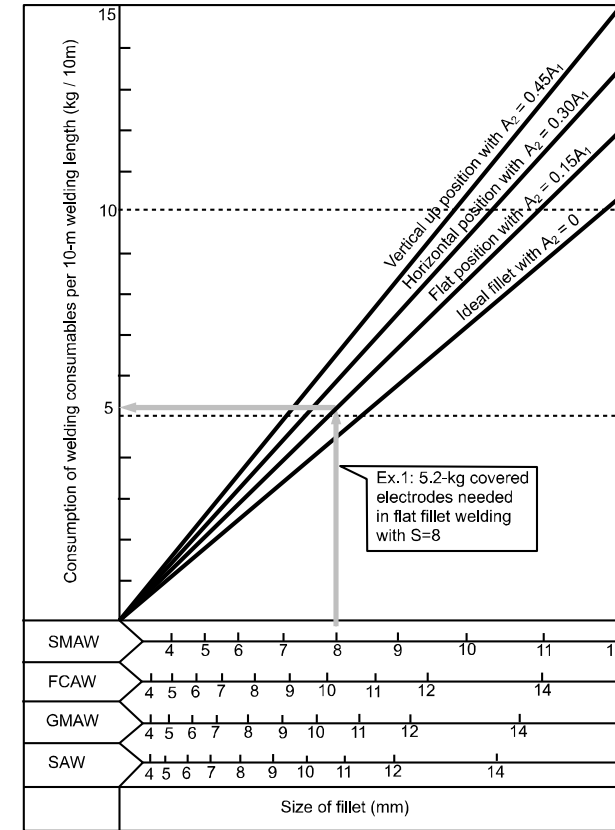

Fig. 2 Consumption of covered electrodes in SMAW, flux-cored wires in FCAW, solid/metal-cored wires in GMAW, and solid wires in SAW of fillet joints

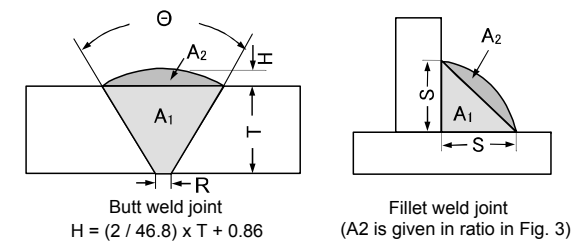

Fig. 3 Weld sizes (Θ in deg., H, R, S, and T in mm)

Conversions for SAW Flux Sizes

The particle size of an individual Kobelco SAW flux is classified with two mesh numbers (e.g., 20 x 200) showing only the largest and the smallest particle size: 20 mesh designates the largest particle size and 200 mesh designates the smallest particle size contained in the bulk flux having specified uniform particle size distribution. These mesh numbers correspond to the largest and the smallest nominal metric sizes of flux particles as shown in Table 1.

Table 1 Conversions for SAW flux sizes ^{(1) (2) (3)}

Nominal metric size	Mesh size
2.36 mm	8
1.70 mm	10
1.40 mm	12
1.18 mm	14
850 μ m	20
500 μ m	32
425 μ m	36
300 μ m	48
212 μ m	65
150 μ m	100
106 μ m	150
75 μ m	200

Note : (1) Nominal metric size is as per JIS Z 8801 (Standard sieve).

(2) Where the particle size of a certain flux is designated as 20 x D for example, this flux contains particles smaller than 75 μ m.

(3) Any SAW flux is specified to contain particles, by 70% or more in amount, within the designated maximum and minimum size range. Where a certain flux contains particles smaller than 75 μ m, this flux is specified to contain particles, by 60% or more in amount, within the maximum and minimum size (75 μ m) range.

Package Specifications for FCAW, GMAW and SAW Wires

FCAW and GMAW spooled wires

Kind of wire	Spool No.	Outside diameter of barrel A (mm)	Outside diameter of flange B (mm)	Outside width of flange D (mm)	Inside diameter of flange E (mm)
Solid 10 kg	SP01	149	225	102	52
Solid 20 kg	SP03	156	270	103	52
FCW 12.5 kg	SP02	192	280	103	52
FCW 15 kg	SP19	179	280	102	52
FCW 20 kg	SP01	140	280	103	52

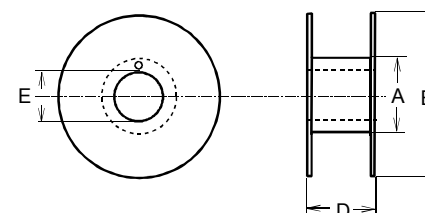

SAW coiled wires

Kind of wire	Inside diameter A (mm)	Outside diameter B (mm)	Width D (mm)
12.5 kg	305	375	64
25 kg (Except 4.8mm wire)	310	410	82
25 kg (4.8mm wire)	310	405	77
75 kg	640	750	115
150 kg (Except 6.4mm wire)	640	825	115
159 kg (6.4mm wire)	640	835	115

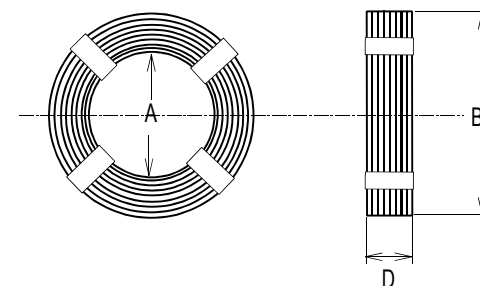

Package Specifications for FCAW and GMAW Wires

Conversions for Temperature

Arrow Pack

1. Principles:

Arrow Pack is a pail-pack of large amounts of flux-cored wires and solid wires for gas shielded arc welding, in which the wire is spooled into the drum from its bottom to the top in coil by a unique way. The wire is spooled to be elastically twisted in the pail so that the wire can be pulled out straight without rotation of the pail. The wire makes good tracking on a welding seam. The use of Arrow Pack wires can reduce the downtime for changing wires when compared with conventional spooled wires, which is effective particularly for robotic welding and other automatic welding.

2. Package specifications:

Solid wire			
Wire size (mm)	Weight (kg)	Pack size dia. x height (mm)	Suitable Arrow Hat
0.8	100	510 × 500	AH-500
0.9	250	510 × 820	AH-500
1.0			
1.4			
1.2	300	510 × 820	AH-500
1.4	300	600 × 820	AH-600
1.6			
1.4			
1.6	400	660 × 820	AH-660

Flux-cored wire			
Wire size (mm)	Weight (kg)	Pack size dia. x height (mm)	Suitable Arrow Hat
1.2	250	510 × 820	AH-500
1.4			
1.6			
1.6	350	660 × 820	AH-660

3. Arrangement of Arrow Pack

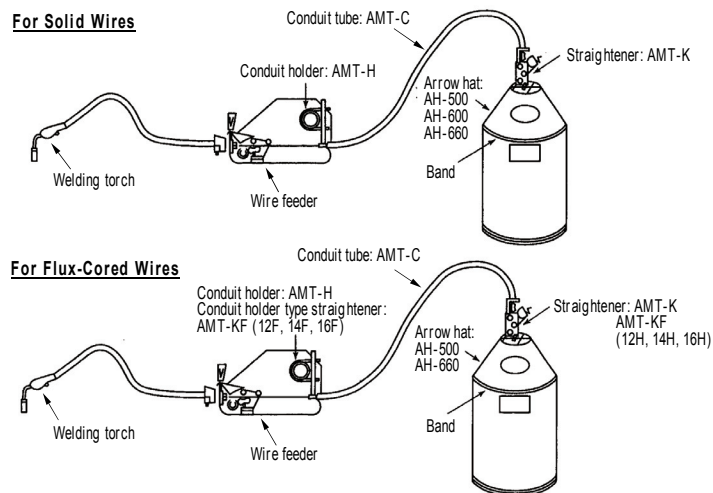

°F	°C	°F	°C	°F	°C	°F	°C	°F	°C	°F	°C
-459.4	-273	-10	-23.3	86	30.0	174	78.9	430	221.1	1240	671
-440	-262	0	-17.8	88	31.1	176	80.0	440	226.7	1260	682
-430	-257	2	-16.7	90	32.2	178	81.1	450	232.2	1280	693
-420	-251	4	-15.6	92	33.3	180	82.2	460	237.8	1300	704
-410	-246	6	-14.4	94	34.4	182	83.3	470	243.3	1320	716
-400	-240	8	-13.3	96	35.6	184	84.4	480	248.9	1340	727
-390	-234	10	-12.2	98	36.7	186	85.6	490	254.4	1360	738
-380	-229	12	-11.1	100	37.8	188	86.7	500	260.0	1380	749
-370	-223	14	-10.0	102	38.9	190	87.8	520	271.1	1400	760
-360	-218	16	-8.9	104	40.0	192	88.9	540	282.2	1420	771
-350	-212	18	-7.8	106	41.1	194	90.0	560	293.3	1440	782
-340	-207	20	-6.7	108	42.2	196	91.1	580	304.4	1460	793
-330	-201	22	-5.6	110	43.3	198	92.2	600	315.6	1480	804
-320	-196	24	-4.4	112	44.4	200	93.3	620	326.7	1500	816
-310	-190	26	-3.3	114	45.6	202	94.4	640	337.8	1520	827
-300	-184	28	-2.2	116	46.7	204	95.6	660	348.9	1540	838
-290	-179	30	-1.1	118	47.8	206	96.7	680	360.0	1560	849
-280	-173	32	0.0	120	48.9	208	97.8	700	371.1	1580	860
-270	-168	34	1.1	122	50.0	210	98.9	720	382.2	1600	871
-260	-162	36	2.2	124	51.1	212	100.0	740	393.3	1620	882
-250	-157	38	3.3	126	52.2	214	101.1	760	404.4	1640	893
-240	-151	40	4.4	128	53.3	216	102.2	780	415.6	1660	904
-230	-146	42	5.6	130	54.4	218	103.3	800	426.7	1680	916
-220	-140	44	6.7	132	55.6	220	104.4	820	437.8	1700	927
-210	-134	46	7.8	134	56.7	230	110.0	840	448.9	1720	938
-200	-129	48	8.9	136	57.8	240	115.6	860	460.0	1740	949
-190	-123	50	10.0	138	58.9	250	121.1	880	471.1	1760	960
-180	-118	52	11.1	140	60.0	260	126.7	900	482.2	1780	971
-170	-112	54	12.2	142	61.1	270	132.2	920	493.3	1800	982
-160	-107	56	13.3	144	62.2	280	137.8	940	504.4	1820	993
-150	-101	58	14.4	146	63.3	290	143.3	960	515.6	1840	1004
-140	-96	60	15.6	148	64.4	300	148.9	980	527	1860	1016
-130	-90	62	16.7	150	65.6	310	154.4	1000	538	1880	1027
-120	-84	64	17.8	152	66.7	320	160.0	1020	549	1900	1038
-110	-79	66	18.9	154	67.8	330	165.6	1040	560	1920	1049
-100	-73	68	20.0	156	68.9	340	171.1	1060	571	1940	1060
-90	-68	70	21.1	158	70.0	350	176.7	1080	582	1960	1071
-80	-62	72	22.2	160	71.1	360	182.2	1100	593	1980	1082
-70	-57	74	23.3	162	72.2	370	187.8	1120	604	2000	1093
-60	-51	76	24.4	164	73.3	380	193.3	1140	616		
-50	-45.6	78	25.6	166	74.4	390	198.9	1160	627		
-40	-40.0	80	26.7	168	75.6	400	204.4	1180	638		
-30	-34.4	82	27.8	170	76.7	410	210.0	1200	649		
-20	-28.9	84	28.9	172	77.8	420	215.6	1220	660		

$$^{\circ}\text{F} = \left(\frac{9}{5} \times ^{\circ}\text{C} \right) + 32$$

$$^{\circ}\text{C} = \frac{5}{9} (^{\circ}\text{F} - 32)$$

Conversions for Tensile Stress

ksi → MPa (Extracted from ASTM E380)

1 ksi = 6.89476 MPa

ksi	0	1	2	3	4	5	6	7	8	9
	MPa									
0	-	6.89	13.79	20.68	27.58	34.47	41.37	48.26	55.16	62.05
10	68.95	75.84	82.74	89.63	96.53	103.42	110.32	117.21	124.11	131.00
20	137.90	144.80	151.68	158.58	165.47	172.37	179.26	186.16	193.05	199.95
30	206.84	213.74	220.63	227.53	234.42	241.32	248.21	255.11	262.00	268.90
40	275.79	282.69	289.58	296.47	303.37	310.26	317.16	324.05	330.95	337.84
50	344.74	351.63	358.53	365.42	372.32	379.21	386.11	393.00	399.90	406.79
60	413.69	420.58	427.47	434.37	441.26	448.16	455.05	461.95	468.84	475.74
70	482.63	489.53	496.42	503.32	510.21	517.11	524.00	530.90	537.79	544.69
80	551.58	558.48	565.37	572.26	579.16	586.05	592.95	599.84	606.74	613.63
90	620.53	627.42	634.32	641.21	648.11	655.00	661.90	668.79	675.69	682.58
100	689.48									

MPa → ksi (Extracted from BS350 Part 2)

1 MPa = 0.145038 ksi

MPa	0	1	2	3	4	5	6	7	8	9
	ksi									
0	-	0.145	0.290	0.435	0.580	0.725	0.870	1.015	1.160	1.305
10	1.450	1.595	1.740	1.886	2.031	2.176	2.321	2.466	2.611	2.756
20	2.901	3.046	3.191	3.336	3.481	3.626	3.771	3.916	4.061	4.206
30	4.351	4.496	4.641	4.786	4.931	5.076	5.221	5.366	5.511	5.656
40	5.802	5.947	6.092	6.237	6.382	6.527	6.672	6.817	6.962	7.107
50	7.252	7.397	7.542	7.687	7.832	7.977	8.122	8.267	8.412	8.557
60	8.702	8.847	8.992	9.137	9.282	9.427	9.572	9.718	9.863	10.008
70	10.153	10.298	10.443	10.588	10.733	10.878	11.023	11.168	11.313	11.458
80	11.603	11.748	11.893	12.038	12.183	12.328	12.473	12.618	12.763	12.908
90	13.053	13.198	13.344	13.489	13.634	13.779	13.924	14.069	14.214	14.359
100	14.504									

Conversions for Impact Energy

ft -lbf → J (Extracted from BS350 Part 2)

1 ft -lbf = 1.35582 J

ft -lbf	0	1	2	3	4	5	6	7	8	9
	J									
0	-	1.36	2.71	4.07	5.42	6.78	8.13	9.49	10.85	12.20
10	13.56	14.91	16.27	17.63	18.98	20.34	21.69	23.05	24.40	25.76
20	27.12	28.47	29.83	31.18	32.54	33.90	35.25	36.61	37.96	39.32
30	40.67	42.03	43.39	44.74	46.10	47.45	48.81	50.17	51.52	52.88
40	54.23	55.59	56.94	58.30	59.66	61.01	62.37	63.72	65.08	66.44
50	67.79	69.15	70.50	71.86	73.21	74.57	75.93	77.28	78.64	79.99
60	81.35	82.70	84.06	85.42	86.77	88.13	89.48	90.84	92.20	93.55
70	94.91	96.26	97.62	98.97	100.33	101.69	103.04	104.40	105.75	107.11
80	108.47	109.82	111.18	112.53	113.89	115.25	116.60	117.96	119.31	120.67
90	122.02	123.38	124.74	126.09	127.45	128.80	130.16	131.51	132.87	134.23
100	135.58									

J → ft -lbf (Extracted from BS350 Part 2)

1 J = 0.737563 ft -lbf

J	0	1	2	3	4	5	6	7	8	9
	ft -lbf									
0	-	0.738	1.475	2.213	2.950	3.688	4.425	5.163	5.901	6.638
10	7.376	8.113	8.851	9.588	10.326	11.063	11.801	12.539	13.276	14.014
20	14.751	15.489	16.226	16.964	17.702	18.439	19.177	19.914	20.652	21.389
30	22.127	22.864	23.602	24.340	25.077	25.815	26.552	27.290	28.027	28.765
40	29.503	30.240	30.978	31.715	32.453	33.190	33.928	34.665	35.403	36.141
50	36.878	37.616	38.353	39.091	39.828	40.566	41.304	42.041	42.779	43.516
60	44.254	44.991	45.729	46.466	47.204	47.942	48.679	49.417	50.154	50.892
70	51.629	52.367	53.105	53.842	54.580	55.317	56.055	56.792	57.530	58.267
80	59.005	59.743	60.480	61.218	61.955	62.693	63.430	64.168	64.906	65.643
90	66.381	67.118	67.856	68.593	69.331	70.068	70.806	71.544	72.281	73.019
100	73.756									

Conversions for Hardness

Vickers Hardness (DPH)	Brinell hardness 10mm ball 3000kg load		Rockwell hardness		Shore hardness	Tensile Strength MPa (approx.)
	Standard ball	Tungsten carbide ball	B-scale	C-scale		
940	-	-	-	68.0	97	-
920	-	-	-	67.5	96	-
900	-	-	-	67.0	95	-
880	-	767	-	66.4	93	-
860	-	757	-	65.9	92	-
840	-	745	-	65.3	91	-
820	-	733	-	64.7	90	-
800	-	722	-	64.0	88	-
780	-	710	-	63.3	87	-
760	-	698	-	62.5	86	-
740	-	684	-	61.8	84	-
720	-	670	-	61.0	83	-
700	-	656	-	60.1	81	-
690	-	647	-	59.7	-	-
680	-	638	-	59.2	80	-
670	-	630	-	58.8	-	-
660	-	620	-	58.3	79	-
650	-	611	-	57.8	-	-
640	-	601	-	57.3	77	-
630	-	591	-	56.8	-	-
620	-	582	-	56.3	75	-
610	-	573	-	55.7	-	-
600	-	564	-	55.2	74	-
590	-	554	-	54.7	-	2095
580	-	545	-	54.1	72	2020
570	-	535	-	53.6	-	1981
560	-	525	-	53.0	71	1952
550	505	517	-	52.3	-	1912
540	496	507	-	51.7	69	1863
530	488	497	-	51.1	-	1824
520	480	488	-	50.5	67	1795
510	473	479	-	49.8	-	1755
500	465	471	-	49.1	66	1706
490	456	460	-	48.4	-	1657
480	448	452	-	47.7	64	1618
470	441	442	-	46.9	-	1569
460	433	433	-	46.1	62	1530
450	425	425	-	45.3	-	1500
440	415	415	-	44.5	59	1461
430	405	405	-	43.6	-	1412
420	397	397	-	42.7	57	1373

Note: These conversions are excerpted from the relevant JIS and ASTM standards, which are based on the data of carbon steels. Therefore, weld metals may exhibit different conversions more or less particularly in the case of alloyed weld metals with higher hardness.

Conversions for Hardness

Vickers Hardness (DPH)	Brinell hardness 10mm ball 3000kg load		Rockwell hardness		Shore hardness	Tensile Strength MPa (approx.)
	Standard ball	Tungsten carbide ball	B-scale	C-scale		
410	388	388	-	41.8	-	1334
400	379	379	-	40.8	55	1285
390	369	369	-	39.8	-	1245
380	360	360	(110.0)	38.8	52	1206
370	350	350	-	37.7	-	1177
360	341	341	(109.0)	36.6	50	1128
350	331	331	-	35.5	-	1098
340	322	322	(108.0)	34.4	47	1069
330	313	313	-	33.3	-	1030
320	303	303	(107.0)	32.2	45	1010
310	294	294	-	31.0	-	981
300	284	284	(105.5)	29.8	42	951
295	280	280	-	29.2	-	941
290	275	275	(104.5)	28.5	41	922
285	270	270	-	27.8	-	902
280	265	265	(103.5)	27.1	40	892
275	261	261	-	26.4	-	873
270	256	256	(102.0)	25.6	38	853
265	252	252	-	24.8	-	843
260	247	247	(101.0)	24.0	37	824
255	243	243	-	23.1	-	804
250	238	238	99.5	22.2	36	794
245	233	233	-	21.3	-	775
240	228	228	98.1	20.3	34	765
230	219	219	96.7	(18.0)	33	736
220	209	209	95.0	(15.7)	32	696
210	200	200	93.4	(13.4)	30	667
200	190	190	91.5	(11.0)	29	637
190	181	181	89.5	(8.5)	28	608
180	171	171	87.1	(6.0)	26	579
170	162	162	85.0	(3.0)	25	549
160	152	152	81.7	(0.0)	24	520
150	143	143	78.7	-	22	490
140	133	133	75.0	-	21	451
130	124	124	71.2	-	20	431
120	114	114	66.7	-	-	392
110	105	105	62.3	-	-	-
100	95	95	56.2	-	-	-
95	90	90	52.0	-	-	-
90	86	86	48.0	-	-	-
85	81	81	41.0	-	-	-

F-No. Grouping and A-No. Classification of Welding Consumables per ASME Sec. IX

Note: The F-No. grouping and A-No. classification of welding consumables shown below are excerpted from ASME Sec. IX 2001 Edition and 2003 Addenda. The F No. and A No. of KOBELCO products are shown in the "List of Welding Consumables" listed at pages from 10 to 21.

F-No. grouping of welding consumables for steels and steel alloys

F No.	ASME Specification No.	AWS Classification No.
1	SFA-5.1, SFA-5.5	EXX20, EXX22, EXX24, EXX27, EXX28
1	SFA-5.4	EXX25, EXX26
2	SFA-5.1, SFA-5.5	EXX12, EXX13, EXX14, EXX19
3	SFA-5.1, SFA-5.5	EXX10, EXX11
4	SFA-5.1, SFA-5.5	EXX15, EXX16, EXX18, EXX48
4	SFA-5.4 (Other than austenitic and duplex)	EXX15, EXX16, EXX17
5	SFA-5.4 (Austenitic and duplex)	EXX15, EXX16, EXX17
6	SFA-5.2	All classifications
6	SFA-5.9	All classifications
6	SFA-5.17	All classifications
6	SFA-5.18	All classifications
6	SFA-5.20	All classifications
6	SFA-5.22	All classifications
6	SFA-5.23	All classifications
6	SFA-5.25	All classifications
6	SFA-5.26	All classifications
6	SFA-5.28	All classifications
6	SFA-5.29	All classifications
6	SFA-5.30	INMs-X, IN5XX, IN3XX

F-No. grouping of welding consumables for nickel and nickel alloys

F No.	ASME Specification No.	AWS Classification No.
41	SFA-5.11	ENi-1
41	SFA-5.14	ERNi-1
41	SFA-5.30	IN61
42	SFA-5.11	ENiCu7
42	SFA-5.14	ERNiCu7, ERNiCu-8

Continued

F No.	ASME specification	AWS classification
42	SFA-5.30	IN60
43	SFA-5.11	ENiCrFe-1, ENiCrFe-2, ENiCrFe-3, ENiCrFe-4, ENiCrFe-7, ENiCrFe-9, ENiCrFe-10, ENiCrCoMo-1, ENiCrMo-2, ENiCrMo-3, ENiCrMo-4, ENiCrMo-5, ENiCrMo-6, ENiCrMo-7, ENiCrMo-10, ENiCrMo-12, ENiCrMo-13, ENiCrMo-14
43	SFA-5.14	ERNiCr-3, ERNiCr-4, ERNiCr-6, ERNiCrFe-5, ERNiCrFe-6, ERNiCrFe-7, ERNiCrFe-8, ERNiCrFe-11, ERNiCrCoMo-1, ERNiCrMo-2, ERNiCrMo-3, ERNiCrMo-4, ERNiCrMo-7, ERNiCrMo-10, ERNiCrMo-13, ERNiCrMo-14, ERNiCrWMo-1, ERNiMo-1,
43	SFA-5.30	IN82, IN62, IN6A, IN52
44	SFA-5.11	ENiMo-1, ENiMo-3, ENiMo-7, ENiMo-8,
44	SFA-5.11	ENiMo-9, ENiMo-10
44	SFA-5.14	ERNiMo-2, ERNiMo-3, ERNiMo-7, ERNiMo-8, ERNiMo-9, ERNiMo-10,
45	SFA-5.11	ENiCrMo-1, ENiCrMo-9, ENiCrMo-11,
45	SFA-5.14	ERNiCrMo-1, ERNiFeCr-1, ERNiCrMo-8, ERNiCrMo-9, ERNiCrMo-11,

A-No. classification of welding consumables

A No.	Types of weld deposit	Chemical composition of weld deposit (%)					
		C	Cr	Mo	Ni	Mn	Si
1	Mild steel	≤0.20	-	-	-	≤1.60	≤1.00
2	C-Mo	≤0.15	≤0.50	0.40-0.65	-	≤1.60	≤1.00
3	Cr (0.4-2%)-Mo	≤0.15	0.40-2.00	0.40-0.65	-	≤1.60	≤1.00
4	Cr (2-6%)-Mo	≤0.15	2.00-6.00	0.40-1.50	-	≤1.60	≤2.00
5	Cr (6-10.5%)-Mo	≤0.15	6.00-10.50	0.40-1.50	-	≤1.20	≤2.00
6	Cr-martensitic	≤0.15	11.00-15.00	≤0.70	-	≤2.00	≤1.00
7	Cr-ferritic	≤0.15	11.00-30.00	≤1.00	-	≤1.00	≤3.00
8	Cr-Ni	≤0.15	14.50-30.00	≤4.00	7.50-15.00	≤2.50	≤1.00
9	Cr-Ni	≤0.30	19.00-30.00	≤6.00	15.00-37.00	≤2.50	≤1.00
10	Ni up to 4%	≤0.15	-	≤0.55	0.80-4.00	≤1.70	≤1.00
11	Mn-Mo	≤0.17	-	0.25-0.75	≤0.85	1.25-2.25	≤1.00
12	Ni-Cr-Mo	≤0.15	≤1.50	0.25-0.80	1.25-2.80	0.75-2.25	≤1.00

Carbon Steel Electrodes for Shielded Metal Arc Welding

Classification system

E ① ② – ③ ④ ⑤ [Ex.] E60 10 E70 16-1 H8 R

E : Designates covered electrodes

① : All-weld metal tensile strength and related requirements

Classification	Tensile strength ⁽¹⁾		Yield strength (0.2%OS) ⁽¹⁾		
	ksi	MPa	ksi	MPa	
E 60	10	60	414	48	331
	11	60	414	48	331
	12	60	414	48	331
	13	60	414	48	331
	18	60	414	48	331
	19	60	414	48	331
	20	60	414	48	331
	22 ⁽⁵⁾	60	414	Not specified	
	27	60	414	48	331
E 70 ⁽⁶⁾	14	70	482	58	399
	15	70	482	58	399
	16	70	482	58	399
	18	70	482	58	399
	24	70	482	58	399
	27	70	482	58	399
	28	70	482	58	399
	48	70	482	58	399
18M ⁽⁴⁾	Note ⁽²⁾	482	53~72 ⁽³⁾	365~496 ⁽³⁾	

Note:(1) Single values are minimum
 (2) Nominal 70ksi (482MPa)
 (3) For 3/32in.(2.4mm) electrodes, the maximum yield point is 77ksi (531MPa)
 (4) For mostly military applications
 (5) Only for single pass welding
 (6) Chemical composition requirements are specified for E70XX weld metal.

② Welding position, type of covering, and related requirements

Classification	Min. elongation 2" (50.8mm) %	Impact value (2V Charpy)			Type of covering	Welding position ⁽¹⁾	Type of current ⁽²⁾	
		Three out of five specimens ⁽³⁾						
		Temp. °F(°C)	Min. average ft-lb(J)	Min. each ft-lb(J)				
E 60	10	22	-20(-29)	20(27)	15(20)	High cellulose sodium	F, V, OH, H	DC(+)
	11	22				High cellulose potassium		AC or DC(+)
	12	17	Not specified			High titania sodium	F, V, OH, H	AC or DC(-)
	13	17				High titania potassium		AC or DC(±)
	18	22	-20(-29)	20(27)	15(20)	Low hydrogen potassium, iron powder	F, V, OH, H	AC or DC(+)
	19	22	0(-18)	20(27)	15(20)	Iron oxide titania	F, V, OH, H	AC or DC(±)
	20	22	Not specified			High iron oxide	H-Fil, F	AC or DC(-) AC or DC(±)
	22	Not specified					F, H	AC or DC(-)
	27	22	-20(-29)	20(27)	15(20)	High iron oxide, iron powder	H-Fil, F	AC or DC(-) AC or DC(±)
	E 70	14	17	Not specified			Iron powder, titania	F, V, OH, H
15		22	-20(-29)	20(27)	15(20)	Low hydrogen sodium	F, V, OH, H	DC(+)
16		22				Low hydrogen potassium		AC or DC(+)
18		22				Low hydrogen potassium, iron powder		F, V, OH, H
24		17	Not specified			Iron powder, titania	H-Fil, F	AC or DC(±)
27		22	-20(-29)	20(27)	15(20)	High iron oxide, iron powder	H-Fil, F	AC or DC(-) AC or DC(±)
28		22	0(-18)	20(27)	15(20)	Low hydrogen potassium, iron powder	H-Fil, F	AC or DC(+)
48		22	-20(-29)	20(27)	15(20)	Low hydrogen potassium, iron powder	F,OH,H,V-down	AC or DC(+)
18M		24	All five specimens ⁽⁴⁾			Low hydrogen, iron powder	F, V, OH, H	DC(+)
			-20(-29)	50(67)	40(54)			

Note:(1) Welding position: F: Flat, H: Horizontal, H-Fil: Horizontal fillet, V-down: Vertical down
 V: Vertical, OH: Overhead (V and OH are applicable for 5/32" (4.0mm) or smaller electrodes as to E7014, E7015, E7016, E7018, E7018M, and for 3/16" (4.8mm) electrodes as to the other types of electrodes)
 (2) Type of current: DC(-) : DC-EN, DC(+): DC-EP, DC(±) : DC-EP or DC-EN
 (3) Among the five specimens, the highest and lowest values shall be discarded in computing the average value. Two of the three remaining values shall be 20ft-lb (27J) or higher.
 (4) All five values obtained shall be used in computing the average. Four of the five values shall be 50ft-lb (67J) or higher.

③ Specification for low temperature impact value (Option)

Classification	Additional Designation	Impact value (2V Charpy)		
		Three out of five specimens		
		Temp. °F(°C)	Average, Min. ft-lb(J)	Each value, Min. ft-lb(J)
E 7016 E 7018 E 7024	1	-50 (-46) 0 (-18)	20 (27) 20 (27)	15 (20) 15 (20)

④ Specification for diffusible hydrogen (Option)

Classification	Additional Designation	Diffusible hydrogen content, Average ml(H ₂)/100g deposited metal, Max
E 7018M	None	4.0
E 7015 E 7016 E 7018 E 7028 E 7048	H16, H8, or H4	16.0, 8.0, or 4.0, respectively

⑤ Specification for absorbed moisture (Option)

Electrode designation	Limit of moisture content (wt%), Max	
	As-received or conditioned	As-exposed
E 7015 E 7016 E 7016-1 E 7018 E 7018-1 E 7028 E 7048	0.6	Not specified
E 7015 E 7016 E 7016-1 E 7018 E 7018-1 E 7028 E 7048	0.3	0.4
E 7018M	0.1	0.4

Low-Alloy Steel Electrodes for Shielded Metal Arc Welding

Classification system

E ① ② – ③ [Ex.] E 70 16 – A1 E 100 18 – D2

E : Designates covered electrodes

① : All-weld-metal tensile strength and related requirements⁽¹⁾

Class.	TS, Min		El., Min (%)	IV, Min. ⁽²⁾ ft-lb (J)
	ksi	MPa		
70	70	480	13-25 according to class.	Av. 20 (27) Each 15 (20) at specific temperature depending on classification
	75	520		
80	80	550		
90	90	620		
100	100	690		
110	110	760		
120	120	830		

Note (1) PWHT is specified depending on classification.
(2) Not specified for EXXX-A1, -BX, -BXL, and -G

② : Type of covering, welding position, and related requirements

Class.	Type of covering	Welding position	Type of current
10	High cellulose sodium	F, V, OH, H	DC(+)
11	High cellulose potassium		AC or DC(+)
13	High-titania potassium	F, V, OH, H	AC or DC(±)
15	Low-hydrogen sodium	F, V, OH, H	DC(+)
16	Low-hydrogen potassium		AC or DC(+)
18	Low-hydrogen potassium, iron powder	F, V, OH, H	AC or DC(+)
20	High-iron oxide	H-Fil	AC or DC(-)
		F	AC or DC(±)
27	High-iron oxide, iron powder	H-Fil	AC or DC(-)
		F	AC or DC(±)

Note: 1. Welding position: F: Flat, V: Vertical, OH: Overhead, H-Fil: Horizontal fillet
2. Type of current: DC(+): DC-EP, DC(-): DC-EN, DC(±):DC-EP or DC-EN

③ Chemical composition of all-weld metal

Class.	Chemical composition (%)									
	C	Mn	Si	P	S	Ni	Cr	Mo	Others	
Electrodes for C-Mn steel										
E 7010 E 7011 E 7020	A1	0.12	0.60	0.40	0.03	0.03	-	-	0.40-0.65	-
E 7015 E 7016			0.90	0.60						
E 7018			0.90	0.80						
E 7027			1.00	0.40						

Note: Single values are maximum.

(Continued)

Class.	Chemical composition (%)									
	C	Mn	Si	P	S	Ni	Cr	Mo	Others	
Electrodes for Cr-Mo steel										
E 8016	B1	0.05-0.12	0.90	0.60	0.03	0.03	-	0.40-0.65	0.40-0.65	-
E 8018				0.80						
E 8016	B2	0.05-0.12	0.90	0.60	0.03	0.03	-	1.00-1.50	0.40-0.65	-
E 8018				0.80						
E 7015	B2L	0.05	0.90	1.00	0.03	0.03	-	1.00-1.50	0.40-0.65	-
E 7016				0.60						
E 7018				0.80						
E 9015	B3	0.05-0.12	0.90	1.00	0.03	0.03	-	2.00-2.50	0.90-1.20	-
E 9016				0.60						
E 9018				0.80						
E 8015	B3L	0.05	0.90	1.00	0.03	0.03	-	2.00-2.50	0.90-1.20	-
E 8018				0.80						
E 8015	B4L	0.05	0.90	1.00	0.03	0.03	-	1.75-2.25	0.40-0.65	-
E 8016	B5	0.07-0.15	0.40-0.70	0.30-0.60	0.03	0.03	-	0.40-0.60	1.00-1.25	V: 0.05
E 8015	B6	0.05-0.10	1.0	0.90	0.03	0.03	0.40	4.0-6.0	0.45-0.65	-
E 8016										
E 8018										
E 8015	B6L	0.05	1.0	0.90	0.03	0.03	0.40	4.0-6.0	0.45-0.65	-
E 8016										
E 8018										
E 8015	B7	0.05-0.10	1.0	0.90	0.03	0.03	0.40	6.0-8.0	0.45-0.65	-
E 8016										
E 8018										
E 8015	B7L	0.05	1.0	0.90	0.03	0.03	0.40	6.0-8.0	0.45-0.65	-
E 8016										
E 8018										
E 8015	B8	0.05-0.10	1.0	0.90	0.03	0.03	0.40	8.0-10.5	0.85-1.20	-
E 8016										
E 8018										
E 8015	B8L	0.05	1.0	0.90	0.03	0.03	0.40	8.0-10.5	0.85-1.20	-
E 8016										
E 8018										
E 9015	B9 ⁽¹⁾	0.08-0.13	1.20	0.30	0.01	0.01	0.80	8.0-10.5	0.85-1.20	V: 0.15-0.30 Cu: 0.25 Al: 0.04 Nb(Cb): 0.02-0.10 N: 0.02-0.07
E 9016										
E 9018										

Note: Single values are maximum. (1) Mn+Ni shall be 1.50% Max.

(Continued)

Class.	Chemical composition (%)									
	C	Mn	Si	P	S	Ni	Cr	Mo	Others	
Electrodes for Ni steel										
E 8016	C1	0.12	1.25	0.60	0.03	0.03	2.00-2.75	-	-	-
E 8018				0.80						
E 7015	C1L	0.05	1.25	0.50	0.03	0.03	2.00-2.75	-	-	-
E 7016										
E 7018										
E 8016	C2	0.12	1.25	0.60	0.03	0.03	3.00-3.75	-	-	-
E 8018				0.80						
E 7015	C2L	0.05	1.25	0.50	0.03	0.03	3.00-3.75	-	-	-
E 7016										
E 7018										
E 8016	C3	0.12	0.40-1.25	0.80	0.03	0.03	0.80-1.10	0.15	0.35	V: 0.05
E 8018										
E 7018	C3L	0.08	0.40-1.40	0.50	0.03	0.03	0.80-1.10	0.15	0.35	V: 0.05
E 8016	C4	0.10	1.25	0.60	0.03	0.03	1.10-2.00	-	-	-
E 8018				0.80						
E 9015	C5L	0.05	0.40-1.00	0.50	0.03	0.03	6.00-7.25	-	-	-
Electrodes for Ni-Mo steel										
E 8018	NM1	0.10	0.80-1.25	0.60	0.02	0.02	0.80-1.10	0.10	0.40-0.65	V: 0.02 Cu: 0.10 Al: 0.05
Electrodes for Mn-Mo steel										
E 8018	D1	0.12	1.00-1.75	0.80	0.03	0.03	0.90	-	0.25-0.45	-
E 9015				0.60						
E10015	D2	0.15	1.65-2.00	0.60	0.03	0.03	0.90	-	0.25-0.45	-
E10016				0.80						
E10018				0.60						
E 8016	D3	0.12	1.00-1.80	0.60	0.03	0.03	0.90	-	0.40-0.65	-
E 8018				0.80						
E 9018										

Note: Single values are maximum.

(Continued)

Stainless Steel Electrodes for Shielded Metal Arc Welding

Classification system

E ① ②

[Ex.] E 308 – 15 E 309 L – 16

E: Designates covered electrodes

①: All-weld metal chemical composition and related requirements

Class.	Chemical composition (%)									
	C	Mn	Si	P	S	Ni	Cr	Mo	Others	
Electrodes for general low-alloy steel										
EXX 10	-	≧ 1.00	≧ 0.80	-	-	≧ 0.50	≧ 0.30	≧ 0.20	V ≧ 0.10 Cu ≧ 0.20	
EXX 11	-	≧ 1.00	≧ 0.80	-	-	≧ 0.50	≧ 0.30	≧ 0.20	V ≧ 0.10 Cu ≧ 0.20	
EXX 13	-	≧ 1.00	≧ 0.80	-	-	≧ 0.50	≧ 0.30	≧ 0.20	V ≧ 0.10 Cu ≧ 0.20	
EXX 15	-	≧ 1.00	≧ 0.80	-	-	≧ 0.50	≧ 0.30	≧ 0.20	V ≧ 0.10 Cu ≧ 0.20	
EXX 16	-	≧ 1.00	≧ 0.80	-	-	≧ 0.50	≧ 0.30	≧ 0.20	V ≧ 0.10 Cu ≧ 0.20	
EXX 18	-	≧ 1.00	≧ 0.80	-	-	≧ 0.50	≧ 0.30	≧ 0.20	V ≧ 0.10 Cu ≧ 0.20	
E 7020	-	≧ 1.00	≧ 0.80	-	-	≧ 0.50	≧ 0.30	≧ 0.20	V ≧ 0.10 Cu ≧ 0.20	
E 7027	-	≧ 1.00	≧ 0.80	-	-	≧ 0.50	≧ 0.30	≧ 0.20	V ≧ 0.10 Cu ≧ 0.20	
Military-similar Electrodes										
E 9018	M	0.10	0.60-1.25	0.80	0.030	0.030	1.40-1.80	0.15	0.35	V: 0.05
E 10018		0.10	0.75-1.70	0.60	0.030	0.030	1.40-2.10	0.35	0.25-0.50	V: 0.05
E 11018		0.10	1.30-1.80	0.60	0.030	0.030	1.25-2.50	0.40	0.25-0.50	V: 0.05
E 12018		0.10	1.30-2.25	0.60	0.030	0.030	1.75-2.50	0.30-1.50	0.30-0.55	V: 0.05
E 12018	M1	0.10	0.80-1.60	0.65	0.015	0.012	3.00-3.80	0.65	0.20-0.30	V: 0.05
Electrodes for pipeline										
E 7010 E 8010	P1	0.20	1.20	0.60	0.03	0.03	1.00	0.30	0.50	V: 0.10
Electrodes for weathering steel										
E7018	W1	0.12	0.40-0.70	0.40-0.70	0.025	0.025	0.20-0.40	0.15-0.30	-	V: 0.08 Cu: 0.30-0.60
E8018	W2	0.12	0.50-1.30	0.35-0.80	0.03	0.03	0.40-0.80	0.45-0.70	-	Cu: 0.30-0.75

Note: Single values are maximum.

(1) The "G" group shall have the minimum of at least one of the elements listed in this table. The letters "XX" stand for various tensile strength levels of weld metal.

Class.	Chemical composition of all-weld metal (%) ⁽¹⁾⁽²⁾											Mechanical properties of all-weld metal (As-welded)		
	C	Cr	Ni	Mo	Nb(Cb)+Ta	Mn	Si	P	S	N	Cu	TS, Min.		El., Min. (%)
												ksi	MPa	
E209	0.06	20.5-24.0	9.5-12.0	1.5-3.0	-	4.0-7.0	1.00	0.04	0.03	0.10-0.30	0.75	100	690	15
E219	0.06	19.0-21.5	5.5-7.0	0.75	-	8.0-10.0	1.00	0.04	0.03	0.10-0.30	0.75	90	620	15
E240	0.06	17.0-19.0	4.0-6.0	0.75	-	10.5-13.5	1.00	0.04	0.03	0.10-0.30	0.75	100	690	15
E307	0.04-0.14	18.0-21.5	9.0-10.7	0.5-1.5	-	3.30-4.75	1.00	0.04	0.03	-	0.75	85	590	30
E308	0.08	18.0-21.0	9.0-11.0	0.75	-	0.5-2.5	1.00	0.04	0.03	-	0.75	80	550	35
E308H	0.04-0.08	18.0-21.0	9.0-11.0	0.75	-	0.5-2.5	1.00	0.04	0.03	-	0.75	80	550	35
E308L	0.04	18.0-21.0	9.0-11.0	0.75	-	0.5-2.5	1.00	0.04	0.03	-	0.75	75	520	35
E308Mo	0.08	18.0-21.0	9.0-12.0	2.0-3.0	-	0.5-2.5	1.00	0.04	0.03	-	0.75	80	550	35
E308LMo	0.04	18.0-21.0	9.0-12.0	2.0-3.0	-	0.5-2.5	1.00	0.04	0.03	-	0.75	75	520	35
E309	0.15	22.0-25.0	12.0-14.0	0.75	-	0.5-2.5	1.00	0.04	0.03	-	0.75	80	550	30
E309H	0.04-0.15	22.0-25.0	12.0-14.0	0.75	-	0.5-2.5	1.00	0.04	0.03	-	0.75	80	550	30
E309L	0.04	22.0-25.0	12.0-14.0	0.75	-	0.5-2.5	1.00	0.04	0.03	-	0.75	75	520	30
E309Nb	0.12	22.0-25.0	12.0-14.0	0.75	0.70-1.00	0.5-2.5	1.00	0.04	0.03	-	0.75	80	550	30
E309Mo	0.12	22.0-25.0	12.0-14.0	2.0-3.0	-	0.5-2.5	1.00	0.04	0.03	-	0.75	80	550	30
E309LMo	0.04	22.0-25.0	12.0-14.0	2.0-3.0	-	0.5-2.5	1.00	0.04	0.03	-	0.75	75	520	30
E310	0.08-0.20	25.0-28.0	20.0-22.5	0.75	-	1.0-2.5	0.75	0.03	0.03	-	0.75	80	550	30
E310H	0.35-0.45	25.0-28.0	20.0-22.5	0.75	-	1.0-2.5	0.75	0.03	0.03	-	0.75	90	620	10
E310Nb	0.12	25.0-28.0	20.0-22.0	0.75	0.70-1.00	1.0-2.5	0.75	0.03	0.03	-	0.75	80	550	25
E310Mo	0.12	25.0-28.0	20.0-22.0	2.0-3.0	-	1.0-2.5	0.75	0.03	0.03	-	0.75	80	550	30
E312	0.15	28.0-32.0	8.0-10.5	0.75	-	0.5-2.5	1.00	0.04	0.03	-	0.75	95	660	22
E316	0.08	17.0-20.0	11.0-14.0	2.0-3.0	-	0.5-2.5	1.00	0.04	0.03	-	0.75	75	520	30
E316H	0.04-0.08	17.0-20.0	11.0-14.0	2.0-3.0	-	0.5-2.5	1.00	0.04	0.03	-	0.75	75	520	30
E316L	0.04	17.0-20.0	11.0-14.0	2.0-3.0	-	0.5-2.5	1.00	0.04	0.03	-	0.75	70	490	30
E316LMn	0.04	18.0-21.0	15.0-18.0	2.5-3.5	-	5.0-8.0	0.90	0.04	0.03	0.10-0.25	0.75	80	550	20
E317	0.08	18.0-21.0	12.0-14.0	3.0-4.0	-	0.5-2.5	1.00	0.04	0.03	-	0.75	80	550	30
E317L	0.04	18.0-21.0	12.0-14.0	3.0-4.0	-	0.5-2.5	1.00	0.04	0.03	-	0.75	75	520	30
E318	0.08	17.0-20.0	11.0-14.0	2.0-3.0	-	0.5-2.5	1.00	0.04	0.03	-	0.75	80	550	25
E320	0.07	19.0-21.0	32.0-36.0	2.0-3.0	8xC-1.00	0.5-2.5	0.60	0.04	0.03	-	3.0-4.0	80	550	30
E320LR	0.03	19.0-21.0	32.0-36.0	2.0-3.0	8xC-0.40	1.50-2.50	0.30	0.020	0.015	-	3.0-4.0	75	520	30
E330	0.18-0.25	14.0-17.0	33.0-37.0	0.75	-	1.0-2.5	1.00	0.04	0.03	-	0.75	75	520	25
E330H	0.35-0.45	14.0-17.0	33.0-37.0	0.75	-	1.0-2.5	1.00	0.04	0.03	-	0.75	90	620	10
E347	0.08	18.0-21.0	9.0-11.0	0.75	8xC-1.00	0.5-2.5	1.00	0.04	0.03	-	0.75	75	520	30
E349	0.13	18.0-21.0	8.0-10.0	0.35-0.65	0.75-1.20	0.5-2.5	1.00	0.04	0.03	-	0.75	100	690	25
E383	0.03	26.5-29.0	30.0-33.0	3.2-4.2	-	0.5-2.5	0.90	0.02	0.02	-	0.6-1.5	75	520	30
E385	0.03	19.5-21.5	24.0-26.0	4.2-5.2	-	1.0-2.5	0.70	0.03	0.02	-	1.2-2.0	75	520	30

(Continued)

Class.	Chemical composition of all-weld metal (%) ^{(1) (2)}										Mechanical properties of all-weld metal ⁽³⁾			
	C	Cr	Ni	Mo	Nb(Cb)+Ta	Mn	Si	P	S	Cu	TS, Min		El., Min. (%)	PWHT
											ksi	MPa		
E409Nb	0.12	11.0-14.0	0.6	0.75	0.50-1.50	1.0	1.00	0.04	0.03	0.75	65	450	20	d
E410	0.12	11.0-13.5	0.7	0.75	-	1.0	0.90	0.04	0.03	0.75	65	450	20	a
E410NiMo	0.06	11.0-12.5	4.0-5.0	0.40-0.70	-	1.0	0.90	0.04	0.03	0.75	110	760	15	c
E430	0.10	15.0-18.0	0.6	0.75	-	1.0	0.90	0.04	0.03	0.75	65	450	20	d
E430Nb	0.10	15.0-18.0	0.6	0.75	0.50-1.50	1.0	1.00	0.04	0.03	0.75	65	450	20	d
E630	0.05	16.00-16.75	4.5-5.0	0.75	0.15-0.30	0.25-0.75	0.75	0.04	0.03	3.25-4.00	135	930	7	e
E16-8-2	0.10	14.5-16.5	7.5-9.5	1.0-2.0	-	0.5-2.5	0.60	0.03	0.03	0.75	80	550	35	None

②: Type of current and welding position

Classification suffix	Type of current	Welding position
-15	DC-EP	All positions
-16	DC-EP or AC	All positions
-17	DC-EP or AC	All positions
-26	DC-EP or AC	H, F

Class.	Chemical composition of all-weld metal (%) ^{(1) (2)}												Mechanical properties of all-weld metal ⁽³⁾			
	C	Cr	Ni	Mo	Nb(Cb)+Ta	Mn	Si	P	S	N	Cu	Others	TS, Min		El., Min. (%)	PWHT
													ksi	MPa		
E2209	0.04	21.5-23.5	8.5-10.5	2.5-3.5	-	0.5-2.0	0.90	0.04	0.03	0.08-0.20	0.75	-	100	690	20	None
E2553	0.06	24.0-27.0	6.5-8.5	2.9-3.9	-	0.5-1.5	1.0	0.04	0.03	0.10-0.25	1.5-2.5	-	110	760	15	None
E2593	0.04	24.0-27.0	8.5-10.5	2.9-3.9	-	0.5-1.5	1.00	0.04	0.03	0.08-0.25	1.5-3.0	-	110	760	15	None
E2594	0.04	24.0-27.0	8.5-10.5	3.5-4.5	-	0.5-2.0	1.00	0.04	0.03	0.20-0.30	0.75	-	110	760	15	None
E2595	0.04	24.0-27.0	8.5-10.5	2.5-4.5	-	2.5	1.2	0.03	0.025	0.20-0.30	0.4-1.5	W: 0.4-1.0	110	760	15	None
E3155	0.10	20.0-22.5	19.0-21.0	2.5-3.5	0.75-1.25	1.0-2.5	1.00	0.04	0.03	-	0.75	Co: 18.5-21.0 V: 2.0-3.0	100	690	20	None
E33-31	0.03	31.0-35.0	30.0-32.0	1.0-2.0	-	2.5-4.0	0.9	0.02	0.01	0.3-0.5	0.4-0.8	-	105	720	25	None

Note: (1) Single values are maximum.

(2) The total of other elements, except iron, shall not present in excess of 0.5%.

(3) All-weld-metal mechanical properties are obtained after the following PWHT:

- a: Heat to 1350 to 1400°F (730 to 760°C), hold for one hour, furnace cool at a rate of 100°F (55°C) per hour to 600°F (315°C) and air cool to ambient.
- b: Heat to 1550 to 1600°F (840 to 870°C), hold for two hours, furnace cool at a rate not exceeding 100°F (55°C) per hour to 1100°F (595°C) and air cool to ambient.
- c: Heat to 1100 to 1150°F (595 to 620°C), hold for one hour, and air cool to ambient.
- d: Heat to 1400 to 1450°F (760 to 790°C), hold for two hours, furnace cool at a rate not exceeding 100°F (55°C) per hour to 1100°F (595°C) and air cool to ambient.
- e: Heat to 1875 to 1925°F (1025 to 1050°C), hold for one hour, and air cool to ambient, and then precipitation harden at 1135 to 1165°F (610 to 630°C), hold for four hours, and air cool to ambient.

Nickel and Nickel Alloy Welding Electrodes for Shielded Metal Arc Welding

Classification system

E ① [Ex.] E NiCu-7

E: Designates covered electrodes

①: Chemical composition of all-weld metal

Class.	Wt % ⁽¹⁾															
	C	Mn	Fe	P	S	Si	Cu	Ni ⁽²⁾	Co	Al	Ti	Cr	Nb(Cb)+Ta	Mo	V	W
ENi-1	0.10	0.75	0.75	0.03	0.02	1.25	0.25	≥92.0	-	1.0	1.0-4.0	-	-	-	-	-
ENiCr-4	0.10	1.5	1.0	0.02	0.02	1.0	0.25	Bal	-	-	-	48.0-52.0	1.0-2.5	-	-	-
ENiCu-7	0.15	4.0	2.5	0.02	0.015	1.5	Bal	62.0-69.0	-	0.75	1.0	-	-	-	-	-
ENiCrFe-1	0.08	3.5	11.0	0.03	0.015	0.75	0.50	≥62.0	-	-	-	13.0-17.0	1.5-4.0 ⁽⁴⁾	0.5-2.5	-	-
ENiCrFe-2	0.10	1.0-3.5	12.0	0.03	0.02	0.75	0.50	≥62.0 ⁽³⁾	-	-	-	13.0-17.0	0.5-3.0 ⁽⁴⁾	0.5-2.5	-	-
ENiCrFe-3	0.10	5.0-9.5	10.0	0.03	0.015	1.0	0.50	≥59.0 ⁽³⁾	-	1.0	1.0	13.0-17.0	1.0-2.5 ⁽⁴⁾	-	-	-
ENiCrFe-4	0.20	1.0-3.5	12.0	0.03	0.02	1.0	0.50	≥60.0	-	-	-	13.0-17.0	1.0-3.5	1.0-3.5	-	-
ENiCrFe-7 ⁽⁵⁾	0.05	5.0	7.0-12.0	0.03	0.015	0.75	0.50	Bal	⁽³⁾	0.50	0.50	28.0-31.5	1.0-2.5	0.5	-	-
ENiCrFe-9	0.15	1.0-4.5	12.0	0.02	0.015	0.75	0.50	≥55.0	-	-	-	12.0-17.0	0.5-3.0	2.5-5.5	-	1.5
ENiCrFe-10	0.20	1.0-3.5	12.0	0.02	0.015	0.75	0.50	≥55.0	-	-	-	13.0-17.0	1.0-3.5	1.0-3.5	-	1.5-3.5
ENiCrFe-12	0.10-0.25	1.0	8.0-11.0	0.04	0.02	1.0	0.20	Bal	1.0	1.5-2.2	0.10-0.40	24.0-26.0	-	-	-	-
ENiCrFeSi-1	0.05-0.20	2.5	21.0-25.0	0.04	0.03	2.5-3.0	0.30	Bal	1.0	0.30	-	26.0-29.0	-	-	-	-
ENiMo-1	0.07	1.0	4.0-7.0	0.04	0.03	1.0	0.50	Bal	2.5	-	-	1.0	-	26.0-30.0	0.60	1.0
ENiMo-3	0.12	1.0	4.0-7.0	0.04	0.03	1.0	0.50	Bal	2.5	-	-	2.5-5.5	-	23.0-27.0	0.60	1.0
ENiMo-7	0.02	1.75	2.25	0.04	0.03	0.2	0.50	Bal	1.0	-	-	1.0	-	26.0-30.0	-	1.0
ENiMo-8	0.10	1.5	10.0	0.02	0.015	0.75	0.50	≥60.0	-	-	-	0.5-3.5	-	17.0-20.0	-	2.0-4.0
ENiMo-9	0.10	1.5	7.0	0.02	0.015	0.75	0.3-1.3	≥62.0	-	-	-	-	-	18.0-22.0	-	2.0-4.0
ENiMo-10	0.02	2.0	1.0-3.0	0.04	0.03	0.2	0.50	Bal	3.0	-	-	1.0-3.0	-	27.0-32.0	-	3.0
ENiMo-11	0.02	2.5	2.0-5.0	0.04	0.03	0.2	0.5	Bal	1.0	0.1-0.5	0.3	0.5-1.5	0.5	26.0-30.0	-	-
ENiCrMo-1	0.05	1.0-2.0	18.0-21.0	0.04	0.03	1.0	1.5-2.5	Bal	2.5	-	-	21.0-23.5	1.75-2.50	5.5-7.5	-	1.0
ENiCrMo-2	0.05-0.15	1.0	17.0-20.0	0.04	0.03	1.0	0.50	Bal	0.50-2.50	-	-	20.5-23.0	-	8.0-10.0	-	0.2-1.0
ENiCrMo-3	0.10	1.0	7.0	0.03	0.02	0.75	0.50	≥55.0 ⁽³⁾	-	-	-	20.0-23.0	3.15-4.15	8.0-10.0	-	-
ENiCrMo-4	0.02	1.0	4.0-7.0	0.04	0.03	0.2	0.50	Bal	2.5	-	-	14.5-16.5	-	15.0-17.0	0.35	3.0-4.5
ENiCrMo-5	0.10	1.0	4.0-7.0	0.04	0.03	1.0	0.50	Bal	2.5	-	-	14.5-16.5	-	15.0-17.0	0.35	3.0-4.5

(Continued)

Class.	Wt % ⁽¹⁾															
	C	Mn	Fe	P	S	Si	Cu	Ni ⁽²⁾	Co	Al	Ti	Cr	Nb(Cb)+Ta	Mo	V	W
ENiCrMo-6	0.10	2.0-4.0	10.0	0.03	0.02	1.0	0.50	≥55.0	-	-	-	12.0-17.0	0.5-2.0	5.0-9.0	-	1.0-2.0
ENiCrMo-7	0.015	1.5	3.0	0.04	0.03	0.2	0.50	Bal	2.0	-	0.70	14.0-18.0	-	14.0-17.0	-	0.5
ENiCrMo-9	0.02	1.0	18.0-21.0	0.04	0.03	1.0	1.5-2.5	Bal	5.0	-	-	21.0-23.5	0.5	6.0-8.0	-	1.5
ENiCrMo-10	0.02	1.0	2.0-6.0	0.03	0.015	0.2	0.50	Bal	2.5	-	-	20.0-22.5	-	12.5-14.5	0.35	2.5-3.5
ENiCrMo-11	0.03	1.5	13.0-17.0	0.04	0.02	1.0	1.0-2.4	Bal	5.0	-	-	28.0-31.5	0.3-1.5	4.0-6.0	-	1.5-4.0
ENiCrMo-12	0.03	2.2	5.0	0.03	0.02	0.7	0.50	Bal	-	-	-	20.5-22.5	1.0-2.8	8.8-10.0	-	-
ENiCrMo-13	0.02	1.0	1.5	0.015	0.01	0.2	-	Bal	-	-	-	22.0-24.0	-	15.0-16.5	-	-
ENiCrMo-14	0.02	1.0	5.0	0.02	0.02	0.25	0.50	Bal	-	-	0.25	19.0-23.0	-	15.0-17.0	-	3.0-4.4
ENiCrMo-17	0.020	0.5	3.0	0.030	0.015	0.2	1.3-1.9	Bal	2.0	-	-	22.0-24.0	-	15.0-17.0	-	-
ENiCrMo-18	0.03	0.7	12.0-15.0	0.03	0.02	0.6	0.3	Bal	1.0	0.5	-	19.0-22.0	0.3	10.0-13.0	0.15	1.0-2.0
ENiCrMo-19 ⁽⁶⁾	0.02	1.5	1.5	0.03	0.02	0.2	0.5	Bal	0.3	0.4	-	20.0-23.0	-	19.0-21.0	-	0.3
ENiCrCoMo-1	0.05-0.15	0.3-2.5	5.0	0.03	0.015	0.75	0.50	Bal	9.0-15.0	-	-	21.0-26.0	1.0	8.0-10.0	-	-
ENiCrWMo-1	0.05-0.10	0.3-1.0	3.0	0.02	0.015	0.25-0.75	0.50	Bal	5.0	0.50	0.10	20.0-24.0	-	1.0-3.0	-	13.0-15.0

- Note: (1) Single values are maximum. The total of other elements shall not be in excess of 0.50%.
 (2) Includes incidental cobalt.
 (3) Cobalt—0.12 maximum, when specified.
 (4) Tantalum—0.30 maximum, when specified.
 (5) Boron is 0.005% maximum and Zr is 0.020% maximum when specified.
 (6) N = 0.02-0.15%.

Welding Electrodes and Rods for Cast Iron

Classification system

E ① [Ex.] E NiFe-CI

E: Designates covered electrodes

①: Chemical composition

Class.	Chemical composition (%) ⁽¹⁾										
	C	Mn	Si	P	S	Fe	Ni ⁽²⁾	Mo	Cu ⁽³⁾	Al	Others
Chemical composition of all-weld metal											
ENi-CI	2.0	2.5	4.0	-	0.03	8.0	≥ 85	-	2.5	1.0	1.0
ENi-CI-A	2.0	2.5	4.0	-	0.03	8.0	≥ 85	-	2.5	1.0-3.0	1.0
ENiFe-CI	2.0	2.5	4.0	-	0.03	Bal	45-60	-	2.5	1.0	1.0
ENiFe-CI-A	2.0	2.5	4.0	-	0.03	Bal	45-60	-	2.5	1.0-3.0	1.0
ENiFeMn-CI	2.0	10-14	1.0	-	0.03	Bal	35-45	-	2.5	1.0	1.0
ENiCu-A	0.35-0.55	2.3	0.75	-	0.025	3.0-6.0	50-60	-	35-45	-	1.0
ENiCu-B	0.35-0.55	2.3	0.75	-	0.025	3.0-6.0	60-70	-	25-35	-	1.0
ENiFeT3-CI ⁽⁴⁾	2.0	3.0-5.0	1.0	-	0.03	Bal	45-60	-	2.5	1.0	1.0
Chemical composition of core wire											
ESt	0.15	0.60	0.15	0.04	0.04	Bal	-	-	-	-	-

Note : (1) Single values are maximum.
 (2) Nickel plus incidental cobalt.
 (3) Copper plus incidental silver.
 (4) No shielding gas shall be used for ENiFeT3-CI.

**A5.17: Carbon Steel Electrodes and Fluxes for Submerged Arc Welding
 A5.23: Low Alloy Steel Electrodes and Fluxes for Submerged Arc Welding**

F ① ② ③ - ④ ⑤ - ⑥ [Ex.] F 6 A 0 - E H14
 F 9 A2 - EC M1 - M1

F: Designates fluxes

① : All-weld metal tensile strength and related requirements ⁽¹⁾

A5.17 A5.23 Code	TS (ksi)	El., Min. (%)
6	60-80	22
7	70-95	22
8	80-100	20
9	90-110	17
10	100-120	16
11	110-130	15
12	120-140	14

Note (1) PWHT is specified depending on classification for tension and impact testing.

②: Heat treatment

Code	Designation
A	As-welded
P	PWHT

⑤: Chemical composition of wire

Code	Type	Code	Type	Code	Type
L8 L8K L12	Low Mn type	A1 A2 A3 A3K A4	Mo type	Ni1 Ni1K Ni2 Ni3 Ni4 Ni5	Ni type
M11K M12 M12K M13K M14K M15K	Medium Mn type	B1 B2 B2H B3 B5 B6 B6H B8 B9	Cr-Mo type	F1 F2 F3 F4 F5 F6 M2 M3 M4 W G	Other alloying type
H10K H11K H12K H14	High Mn type				
1 G	Weld metal chemical composition of composite wires				

③ : Impact value of all-weld metal ⁽¹⁾

A5.17 A5.23 Code	Temp. (°F)	IV, Min. (ft-lb)
Z	-	Av. 20 Each 15
0	0	
2	-20	
4	-40	
5	-50	
6	-60	
8	-80	
10	-100	
15	-150	

④: Type of wire

Code	Designation
E	Solid wire
EC	Composite wire

⑥: Chemical composition of weld metal

Code	Type	Code	Type
A1 A2 A3 A4	Mo type	Ni1 Ni2 Ni3 Ni4 Ni5	Ni type
B1 B2 B2H B3 B4 B5 B6 B6H B8 B9	Cr-Mo type	F1 F2 F3 F4 F5 F6 M1 M2 M3 M4 M5 M6 W G	Other alloying type

A5.18: Carbon Steel Electrodes and Rods for Gas Shielded Metal Arc Welding
A5.28: Low-Alloy Steel Electrodes and Rods for Gas Shielded Metal Arc Welding

Classification system

ER (or E) ① ② – ③ ④ ⑤

A5.18: [Ex.] ER 70 S – 2, E 70 C – 3 M, E 70 C – 3 M H16
 A5.28: ER 80 S – B2, E 80 C – B2 H16

ER: Designates welding electrodes or rods.

E: Designates welding electrodes

①: All-weld metal tensile strength and related requirements ⁽¹⁾

Code	TS, Min.		El., Min. (%)	IV ₁ ⁽²⁾ Min. (ft-lb)
	ksi	MPa		
70	70	480	14-24 according to classification	Average 20 Each 15 at specific temperature depending on classification
	75 (A5.28)	515 (A5.28)		
80	80	550		
90	90	620		
100	100	690		
10	110	760		
120	120	830		

Note (1) PWHT is specified depending on classification.
 (2) Not required for Mo and Cr-Mo type filler wires.

②: Type of wire

Code	Designation
S	Solid wire
C	Composite wire

④: Type of shielding gas (A 5.18)

Code	Designation
C	CO ₂
M	75-80%Ar-20-25%CO ₂

③: Chemical composition of wire or all-weld metal (A 5.18)

Class.	Suffix	Shielding gas	Type
ER 70 S	2	CO ₂	Carbon steel type
ER 70 S	3		
ER 70 S	4		
ER 70 S	6		
ER 70 S	7		
ER 70 S	G		
E 70 C	3	75-80%Ar/bal.CO ₂ or CO ₂	
E 70 C	6		
E 70 C	G	(2)	
E 70 C	GS ⁽¹⁾		

Note : (1) For single pass
 (2) As agreed upon between purchaser and supplier

⑤: Diffusible hydrogen (Option) (A 5.18)

Code	Diffusible hydrogen, ml/100g deposited metal Max.
H16	16.0
H8	8.0
H4	4.0

③: Chemical composition of wire or all-weld metal (A 5.28)

Class.	Suffix	Shielding gas	Type
ER 70 S	A1	Argon/1-5%O ₂	C-0.5Mo steel
E 90 C	D2	Argon/1-5%O ₂	1.5Mn-0.5Mo steel
ER 80 S	B2	Argon/1-5%O ₂	1.25Cr-0.5Mo steel
ER 70 S	B2L		
E 70 C	B2L		
E 80 C	B2		
ER 90 S	B3	Argon/1-5%O ₂	2.25Cr-1Mo steel
ER 80 S	B3L		
E 80 C	B3L		
E 90 C	B3	Argon/1-5%O ₂	5Cr-0.5Mo steel
ER 80 S	B6		
ER 80 S	B8	Argon/1-5%O ₂	9Cr-1Mo steel
ER 90 S	B9	Argon/5%O ₂	9Cr-1Mo-0.2V steel
ER 80 S	Ni1	Argon/1-5%O ₂	Ni steel
E 80 C	Ni1		
ER 80 S	Ni2		
E 70 C	Ni2		
E 80 C	Ni2		
ER 80 S	Ni3		
E 80 C	Ni3		
ER 80 S	D2		
ER 90 S	D2	Argon/1-5%O ₂	Other low alloy steels
ER 100 S	1	Argon/2%O ₂	
ER 110 S	1		
ER 120 S	1	(1)	Not specified ⁽²⁾
ER xx S	G ⁽¹⁾		
E xx C			

Note: (1) As agreed upon between purchaser and supplier

④: Diffusible hydrogen (Option) (A 5.28)

Additional Designation	Diffusible hydrogen ml/100g deposited metal, Max.
H16	16.0
H8	8.0
H4	4.0
H2	2.0

A5.20: Carbon Steel Electrodes for Flux Cored Arc Welding
A5.29: Low Alloy Electrodes for Flux Cored Arc Welding

Classification system

A 5.20 : E [①] [②] T - [③] [④] - J HZ [Ex.] E Z 1 T - 1 M - J H8

A 5.29 : E [①] [②] T [③] - [⑤] [④] - J HZ [Ex.] E 8 1 T 1 - B2 M - J H8

E: Designates electrodes

①: All-weld metal tensile strength and related requirements⁽¹⁾

Code	TS		IV, Min. ft-lb (J)
	ksi	MPa	
6	60-80	410-550	Average 20 (27) Each 15 (20) at specific temperature depending on classification
7	70-90	480-620	
8	80-100	550-690	
9	90-110	620-760	
10	100-120	690-830	
11	110-130	760-900	
12	120-140	830-970	

Note (1) PWHT is required depending on classification

④: Shielding gas

②: Welding position		Suffix	Designation
Code	Designation	M	75-80%Ar / Bal. CO ₂
0	F, H-Fil	C	CO ₂
1	All positions	None	Self-shield

⑤: Chemical composition of all-weld metal (A 5.29)

Suffix	Type	Suffix	Type
A1	C-Mo steel	Ni1	Ni steel
B1	Cr-Mo steel	Ni2	
B1L		Ni3	
B2		D1	Mn-Mo steel
B2L		D2	
B2H		D3	
B3		Other low-alloy steels	K1
B3L			K2
B3H			K3
B6			K4
B6L			K5
B6L			K6
B8			K7
B8L	K8		
	K9		
	W2		
	G		

T: Designates flux-cored electrodes

③: Performances

Suffix ⁽¹⁾	Performances (Type of flux, Polarity, Application)
1	MAG, Rutile type, Fillet welding (Multi-pass)
2	MAG, Rutile type, Fillet welding (Single pass)
3	Self-shielded, DC-EP, High welding speed
4	Self-shielded, DC-EP, High deposition rate
5	MAG, Lime type, High impact value, Good crack resistance
6	Self-shielded, DC-EP, High impact value
7	Self-shielded, DC-EN, High deposition rate
8	Self-shielded, DC-EN, High deposition rate
9	MAG, Rutile type, DC-EP, Small size: for all positions
10	Self-shielded, DC-EN, High welding speed
11	Self-shielded, DC-EN, Good usability
12	MAG, Rutile type, DC-EP, High impact value
13	Self-shielded, DC-EN, Root pass welding of pipes
14	Self-shielded, DC-EN, All positions, High welding speed
G	Not specified, For multiple-pass welding
GS	Not specified, For single-pass welding

Note: (1) A 5.29 designates 1, 4, 5, 6, 7, 8, 11 or G only.

[Option]

J: Satisfies the minimum Charpy impact value 27J at -40°C (A5.20) or at a test temperature of 11°C lower (A5.29) than the specified temperature

HZ: Diffusible hydrogen

Suffix	Diffusible hydrogen, Max. ml/100g deposited metal
H16	16.0
H8	8.0
H4	4.0
None ⁽¹⁾	8.0

Note (1) A 5.29 only

Carbon and Low Alloy Steel Electrodes for Electrode Gas Welding

Classification system

EG [①] [②] [③] [Ex.] EG 6 0 T (or S) 1

EG: Designates electrode gas welding electrodes

T: Designates cored electrodes

S: Designates solid electrodes

①: Tensile strength of all-weld metal

Code	Tensile strength	
	ksi	MPa
6	60-80	420-550
7	70-95	490-650
8	80-100	550-690

②: Impact value of all-weld metal

Code	Impact value (2V Charpy)	
	Temp.°F(°C)	ft-lb(J)
Z	Not specified	
0	0 (-18)	20 (27)
2	-20 (-29)	20 (27)

③: Chemical composition

Class	Suffix	Chemical composition of solid wire (%) ⁽¹⁾											
		C	Mn	S	P	Si	Ni	Mo	Cu	Ti	Zr	Al	Others
EGXXS	1	0.07-0.19	0.90-1.40	0.035	0.025	0.30-0.50	-	-	0.35	-	-	-	0.50
	2	0.07	0.90-1.40	0.035	0.025	0.40-0.70	-	-	0.35	0.05-0.15	0.02-0.12	0.05-0.15	0.50
	3	0.06-0.15	0.90-1.40	0.035	0.025	0.45-0.75	-	-	0.35	-	-	-	0.50
	5	0.07-0.19	0.90-1.40	0.035	0.025	0.30-0.60	-	-	0.35	-	-	0.50-0.90	0.50
	6	0.06-0.15	1.40-1.85	0.035	0.025	0.80-1.15	-	-	0.35	-	-	-	0.50
	D2	0.07-0.12	1.60-2.10	0.035	0.025	0.50-0.80	0.15	0.40-0.60	0.35	-	-	-	0.50
	G	Not specified											

Note: (1) Single values are maximum.

Class	Suffix	Shielding gas	Chemical composition of all-weld metal of composite wires (%) ⁽¹⁾										
			C	Mn	P	S	Si	Ni	Cr	Mo	Cu	V	Others
EG6XT	1	None	(2)	1.7	0.03	0.03	0.50	0.30	0.20	0.35	0.35	0.08	0.50
EG7XT	1	None	(2)	1.7	0.03	0.03	0.50	0.30	0.20	0.35	0.35	0.08	0.50
EG6XT	2	CO ₂	(2)	2.0	0.03	0.03	0.90	0.30	0.20	0.35	0.35	0.08	0.50
EG7XT	2	CO ₂	(2)	2.0	0.03	0.03	0.90	0.30	0.20	0.35	0.35	0.08	0.50
EGXXT	Ni1	CO ₂	0.10	1.0-1.8	0.03	0.03	0.50	0.70-1.10	-	0.30	0.35	-	0.50
EGXXT	NM1	Ar-CO ₂ or CO ₂	0.12	1.0-2.0	0.02	0.03	0.15-0.50	1.5-2.0	0.20	0.40-0.65	0.35	0.05	0.50
EGXXT	NM2	CO ₂	0.12	1.1-2.1	0.03	0.03	0.20-0.60	1.1-2.0	0.20	0.10-0.35	0.35	0.05	0.50
EGXXT	W	CO ₂	0.12	0.50-1.3	0.03	0.03	0.30-0.80	0.40-0.80	0.45-0.70	-	0.30-0.75	-	0.50
EGXXT	G	Not specified											

Note: (1) Single values are maximum.

(2) Composition range of carbon not specified for these classifications, but the amount shall be determined and reported.

**Stainless Steel Electrodes for Flux Cored Arc Welding and
Stainless Steel Flux-Cored Rods for Gas Tungsten Arc Welding**

Classification system

E ① T ② - ③ [Ex.] E 308L T 1 -1
R ① T ② - ③ [Ex.] R 308L T 1 -5

E: Designates welding electrodes
R: Designates welding rods
T: Designates flux-core electrodes or rods

①: Weld metal chemical composition and related requirements (See A5.22 for self-shielded wires)

Class.	Chemical composition of all-weld metal (%) ^{(1) (2)}										Mechanical properties of all-weld metal (As-welded)		
	C	Cr	Ni	Mo	Cb+Ta	Mn	Si	P	S	Cu	TS, Min		El., Min. (%)
											ksi	MPa	
E307	0.13	18.0-20.5	9.0-10.5	0.5-1.5	-	3.30-4.75	1.0	0.04	0.03	0.5	85	590	30
E308	0.08	18.0-21.0	9.0-11.0	0.5	-	0.5-2.5	1.0	0.04	0.03	0.5	80	550	35
E308H	0.04-0.08	18.0-21.0	9.0-11.0	0.5	-	0.5-2.5	1.0	0.04	0.03	0.5	80	550	35
E308L	0.04	18.0-21.0	9.0-11.0	0.5	-	0.5-2.5	1.0	0.04	0.03	0.5	75	520	35
E308Mo	0.08	18.0-21.0	9.0-11.0	2.0-3.0	-	0.5-2.5	1.0	0.04	0.03	0.5	80	550	35
E308LMo	0.04	18.0-21.0	9.0-12.0	2.0-3.0	-	0.5-2.5	1.0	0.04	0.03	0.5	75	520	35
E309	0.10	22.0-25.0	12.0-14.0	0.5	-	0.5-2.5	1.0	0.04	0.03	0.5	80	550	30
E309L	0.04	22.0-25.0	12.0-14.0	0.5	-	0.5-2.5	1.0	0.04	0.03	0.5	75	520	30
E309LCb	0.04	22.0-25.0	12.0-14.0	0.5	0.70-1.00	0.5-2.5	1.0	0.04	0.03	0.5	75	520	30
E309Mo	0.12	21.0-25.0	12.0-16.0	2.0-3.0	-	0.5-2.5	1.0	0.04	0.03	0.5	80	550	25
E309LMo	0.04	21.0-25.0	12.0-16.0	2.0-3.0	-	0.5-2.5	1.0	0.04	0.03	0.5	75	520	25
E309LNiMo	0.04	20.5-23.5	15.0-17.0	2.5-3.5	-	0.5-2.5	1.0	0.04	0.03	0.5	75	520	25
E310	0.20	25.0-28.0	20.0-22.5	0.5	-	1.0-2.5	1.0	0.03	0.03	0.5	80	550	30
E312	0.15	28.0-32.0	8.0-10.5	0.5	-	0.5-2.5	1.0	0.04	0.03	0.5	95	660	22
E316	0.08	17.0-20.0	11.0-14.0	2.0-3.0	-	0.5-2.5	1.0	0.04	0.03	0.5	75	520	30
E316L	0.04	17.0-20.0	11.0-14.0	2.0-3.0	-	0.5-2.5	1.0	0.04	0.03	0.5	70	485	30
E317L	0.04	18.0-21.0	12.0-14.0	3.0-4.0	-	0.5-2.5	1.0	0.04	0.03	0.5	75	520	20
E347	0.08	18.0-21.0	9.0-11.0	0.5	8xC-1.00	0.5-2.5	1.0	0.04	0.03	0.5	75	520	30
R308L	0.03	18.0-21.0	9.0-11.0	0.5	-	0.5-2.5	1.2	0.04	0.03	0.5	75	520	35
R309L	0.03	22.0-25.0	12.0-14.0	0.5	-	0.5-2.5	1.2	0.04	0.03	0.5	75	520	30
R316L	0.03	17.0-20.0	11.0-14.0	2.0-3.0	-	0.5-2.5	1.2	0.04	0.03	0.5	70	485	30
R347	0.08	18.0-21.0	9.0-11.0	0.5	8xC-1.00	0.5-2.5	1.2	0.04	0.03	0.5	75	520	30

(Continued)

Class.	Chemical composition of all-weld metal (%) ^{(1) (2)}									Mechanical properties of all-weld metal ⁽³⁾			
	C	Cr	Ni	Mo	Mn	Si	P	S	Cu	TS, Min		El., Min. (%)	PWHT
										ksi	MPa		
E409	0.10	10.5-13.5	0.60	0.5	0.80	1.0	0.04	0.03	0.5	65	450	15	None
E410	0.12	11.0-13.5	0.60	0.5	1.2	1.0	0.04	0.03	0.5	75	520	20	(a)
E410NiMo	0.06	11.0-12.5	4.0-5.0	0.40-0.70	1.0	1.0	0.04	0.03	0.5	110	760	15	(b)
E410NiTi	0.04	11.0-12.0	3.6-4.5	0.5	0.70	0.50	0.03	0.03	0.5	110	760	15	(b)
E430	0.10	15.0-18.0	0.60	0.5	1.2	1.0	0.04	0.03	0.5	65	450	20	(c)
E502	0.10	4.0-6.0	0.40	0.45-0.65	1.2	1.0	0.04	0.03	0.5	60	415	20	(d)
E505	0.10	8.0-10.5	0.40	0.85-1.20	1.2	1.0	0.04	0.03	0.5	60	415	20	(d)

(Continued)

Class.	Chemical composition of all-weld metal (%) ^{(1) (2)}										Mechanical properties of all-weld metal ⁽³⁾			
	C	Cr	Ni	Mo	Mn	Si	P	S	N	Cu	TS, Min		El., Min. (%)	PWHT
											ksi	MPa		
E2209	0.04	21.0-24.0	7.5-10.0	2.5-4.0	0.5-2.0	1.0	0.04	0.03	0.08-0.20	0.5	100	690	20	None
E2553	0.04	24.0-27.0	8.5-10.5	2.9-3.9	0.5-1.5	0.75	0.04	0.03	0.10-0.20	1.5-2.5	110	760	15	None

Note: (1) Single values are maximum.

(2) The total of other elements, except iron, shall not present in excess of 0.5%.

(3) All-weld-metal mechanical properties are obtained after the following PWHT:

- a: Heated to 1350 to 1400°F (732 to 760°C), held for 1 hour, then furnace cooled to 600°F (315°C) at a rate not to exceed 100°F (55°C) per hour, then cooled in air to room temperature.
- b: Heated to 1100 to 1150°F (593 to 621°C), held for 1 hour, then cooled in air to room temperature.
- c: Heated to 1400 to 1450°F (760 to 788°C), held for 4 hours, then furnace cooled to 1100°F (593°C) at a rate not to exceed 100°F (55°C) per hour, then cooled in air to room temperature.
- d: Heated to 1550 to 1600°F (840 to 870°C), held for 2 hours, then furnace cooled to 1100°F (595°C) at a rate not to exceed 100°F (55°C) per hour, then cool in air to room temperature.

② Position of welding

Code	Welding position
0	Flat and horizontal
1	All positions

③ External shielding medium and related requirements

Code	External shielding medium	Welding polarity	Welding process
1	CO ₂	DC-EP	FCAW
3	None (self-shielded)	DC-EP	FCAW
4	75-80%Ar/bal. CO ₂	DC-EP	FCAW
5	100%Argon	DC-EN	GTAW

Nickel-Alloy Electrodes for Flux Cored Arc Welding

Classification system

ENi ① T ② - ③ [Ex.] ENi Cr3 T 0 -4

TNi ① - ② ③ [Ex.] TNi 6082 -0 4

E: Designates welding electrodes

T: Designates tubular or flux-cored electrodes

①: Weld metal chemical and mechanical requirements

Classification		Chemical composition of all-weld metal (%) ⁽¹⁾⁽²⁾									
Traditional	ISO format	C	Mn	Fe	P	S	Si	Cu	Ni ⁽³⁾	Co	Ti
Cr3	6082	0.10	2.5-3.5	3.0	0.03	0.015	0.50	0.50	67.0 min.	(5)	0.75
CrFe1	6062	0.08	3.5	11.0	0.03	0.015	0.75	0.50	62.0 min.	-	-
CrFe2	6133	0.10	1.0-3.5	12.0	0.03	0.02	0.75	0.50	62.0 min.	(5)	-
CrFe3	6182	0.10	5.0-9.5	10.0	0.03	0.015	1.0	0.50	59.0 min.	(5)	1.0
CrMo2	6002	0.05-0.15	1.0	17.0-20.0	0.04	0.03	1.0	0.50	Bal	0.50-2.50	-
CrMo3	6625	0.10	0.5	5.0 ⁽⁴⁾	0.02	0.015	0.50	0.50	58.0min.	(5)	0.40
CrMo4	6276	0.02	1.0	4.0-7.0	0.03	0.03	0.2	0.50	Bal	2.5	-
CrMo10	6022	0.02	1.0	2.0-6.0	0.03	0.015	0.2	0.50	Bal	2.5	-
CrCoMo1	6117	0.05-0.15	0.3-2.5	5.0	0.03	0.015	0.75	0.50	Bal	9.0-15.0	-

①: Weld metal chemical and mechanical requirements (Continued)

Classification		Chemical composition of all-weld metal (%) ⁽¹⁾⁽²⁾					Mechanical properties of all-weld metal ⁽⁷⁾		
Traditional	ISO format	Cr	Nb(Cb)+ Ta ⁽⁶⁾	Mo	V	W	TS, Min		El., Min. (%)
							ksi	MPa	
Cr3	6082	18.0-22.0	2.0-3.0	-	-	-	80	550	25
CrFe1	6062	13.0-17.0	1.5-4.0	-	-	-	80	550	25
CrFe2	6133	13.0-17.0	0.5-3.0	0.5-2.5	-	-	80	550	25
CrFe3	6182	13.0-17.0	1.0-2.5	-	-	-	80	550	25
CrMo2	6002	20.5-23.0	-	8.0-10.0	-	0.2-1.0	90	620	25
CrMo3	6625	20.0-23.0	3.15-4.15	8.0-10.0	-	-	100	690	25
CrMo4	6276	14.5-16.5	-	15.0-17.0	0.35	3.0-4.5	100	690	25
CrMo10	6022	20.0-22.5	-	12.5-14.5	0.35	2.5-3.5	100	690	25
CrCoMo1	6117	21.0-26.0	1.0	8.0-10.0	-	-	90	620	25

(1) Single values are maximum.

(2) The total of other elements shall not present in excess of 0.50%.

(3) Includes residual cobalt.

(4) Iron is 1.0 maximum when specified.

(5) Cobalt is 0.10 Maximum when specified.

(6) Tantalum is 0.30 maximum when specified.

(7) As-welded condition.

② Welding position

Code	Welding position
0	Flat and horizontal
1	All positions

③ Shielding gas

Code	External shielding medium
1	CO ₂
3	None (self-shielded)
4	75-80%Ar/bal. CO ₂

Covered electrodes for manual metal arc welding of non-alloy and fine grain steels

Classification (System A)

EN ISO 2560-A-E ① ② ③ ④ ⑤ ⑥ ⑦

[Ex.] EN ISO 2560-A-E 46 3 1Ni B 5 4 H5

E: Designates covered electrodes for manual metal arc welding

①: All-weld metal yield strength and related requirements

Code	Yield strength or 0.2% offset strength, Min. (N/mm ²)	Tensile strength (N/mm ²)	Elongation (L=5D) Min. (%)
35	355	440-570	22
38	380	470-600	20
42	420	500-640	20
46	460	530-680	20
50	500	560-720	18

②: Impact value of all-weld metal

Code	Test temp. (°C)	Impact absorbed energy Min. (J)
Z	Not required	Average 47
A	+20	
0	0	
2	-20	
3	-30	
4	-40	
6	-60	

③: Chemical composition of all-weld metal

Code	Chemical composition ⁽¹⁾ (%)		
	Mn	Mo	Ni
No symbol	2.0	—	—
Mo	1.4	0.3-0.6	—
MnMo	>1.4-2.0	0.3-0.6	—
1Ni	1.4	—	0.6-1.2
2Ni	1.4	—	1.8-2.6
3Ni	1.4	—	>2.6-3.8
Mn1Ni	>1.4-2.0	—	0.6-1.2
1NiMo	1.4	0.3-0.6	0.6-1.2
Z	Other elements as agreed		

Note: (1) Single values are maximums.
If not specified, Mo<0.2%, Ni<0.3%,
Cr<0.2%, V<0.05%, Nb<0.05%,
Cu<0.3%

④: Type of covering

Code	Type of electrode covering
A	Acid covering
C	Cellulose covering
R	Rutile covering
RR	Rutile thick covering
RC	Rutile-cellulosic covering
RA	Rutile-acid covering
RB	Rutile-basic covering
B	Basic covering

⑤: Weld metal recovery and type of current (Option)

Code	Weld metal recovery (%)	Type of current
1	≤105	AC, DC
2	≤105	DC
3	>105 ≤125	AC, DC
4	>105 ≤125	DC
5	>125 ≤160	AC, DC
6	>125 ≤160	DC
7	>160	AC, DC
8	>160	DC

⑥: Welding position (Option)

Code	Designation
1	All positions
2	All positions except vertical down
3	Flat butt, flat fillet and Horizontal-vertical fillet
4	Flat butt and fillet
5	Vertical-down and those specified in the code 3

⑦: Diffusible hydrogen (Option)

Code	Diffusible hydrogen, Max. ml/100g all-weld metal
H5	5
H10	10
H15	15

Tubular Cored Electrodes for Gas Shielded or Self-Shielded Metal Arc Welding of Non-Alloy and Fine-Grain Steels

Classification (System A)

EN ISO 17632-A - T ① ② ③ ④ ⑤ ⑥ ⑦

[Ex.] EN ISO 17632-A - T 46 3 1Ni B M 4 H5

T: Designates tubular cored electrodes for metal arc welding

①: Yield strength and related requirements

(a) Multiple-layer welding:

Yield strength of all-weld metal

Code	Yield strength or 0.2% offset strength Min. (N/mm ²)	Tensile strength (N/mm ²)	Elongation (L=5D) Min. (%)
35	355	440~570	22
38	380	470~600	20
42	420	500~640	20
46	460	530~680	20
50	500	560~720	18

(b) Single pass welding:

Yield strength of weld joint

Code	Yield strength of base metal Min. (N/mm ²)	Tensile strength of weld joint Min. (N/mm ²)
3T	355	470
4T	420	520
5T	500	600

②: Impact value of all-weld metal or weld joint

Code	Test temp. (°C)	Impact absorbed energy Min. (J)
Z	Not required	Average 47
A	+20	
0	0	
2	-20	
3	-30	
4	-40	
6	-60	

③: Chemical composition of all-weld metal

Code	Chemical composition ⁽¹⁾ (%)		
	Mn	Ni	Mo
-	2.0	-	-
Mo	1.4	-	0.3-0.6
MnMo	1.4~2.0	-	0.3-0.6
1Ni	1.4	0.6-1.2	-
1.5Ni	1.6	1.2-1.8	-
2Ni	1.4	1.8-2.6	-
3Ni	1.4	2.6-3.8	-
Mn1Ni	1.4~2.0	0.6-1.2	-
1NiMo	1.4	0.6-1.2	0.3-0.6
Z	Other elements as agreed		

Note: (1) Single values are maximum.
Where no specification, Mo<0.2%, Ni<0.5%, Cr<0.2%, V<0.08%, Nb<0.05%, Cu<0.3%, and for self-shielded wires, Al<2.0%

④: Type of cored flux

Code	Features	Type of welding	Shielding gas
R	Rutile, Slow-freezing slag	Single pass or multiple pass	Required
P	Rutile, Fast-freezing slag		
B	Basic		
M	Metal powder	Single pass	Not required
V	Rutile or basic / Fluorides		
W	Basic / Fluorides, Slow-freezing slag		
Y	Basic / Fluorides Fast-freezing slag	Single pass or multiple pass	Not required
Z	Other types		

⑤: Shielding gas

Code	Designation
M	Gas mixtures (Gases specified as M2 per EN 439, excepting He)
C	CO ₂ (Gases specified as C1 per EN 439)
N	Self-shielded

⑥: Welding position (Option)

Code	Designation
1	All positions
2	All positions except vertical downward
3	Flat butt and fillet, Horizontal fillet
4	Flat butt and fillet
5	Vertical downward and those specified in the code 3

⑦: Diffusible hydrogen (Option)

Code	Diffusible hydrogen, Max. ml/100g deposited metal
H5	5
H10	10
H15	15

Tubular cored electrodes for gas-shielded and non-gas shielded metal arc welding of high-strength steels

Classification (System A)

EN ISO 18276-A - T ① ② ③ ④ ⑤ ⑥ ⑦ ⑧

[Ex.] EN ISO 18276-A - T 55 5 Mn1.5Ni B M 4 H5 T

T: Designates tubular cored electrodes for gas-shielded and non-gas shielded metal arc welding

①: All-weld metal yield strength and related requirements

Code	Yield point or 0.2% offset strength, Min. (N/mm ²)	Tensile strength (N/mm ²)	Elongation (L=5D) (%)
55	550	640-820	18
62	620	700-890	18
69	690	770-940	17
79	790	880-1080	16
89	890	940-1180	15

②: Impact value of all-weld metal

Code	Absorbed energy of 47J, Three-specimen average, (1) Test temp. (°C)
Z	Not specified
A	+20
0	0
2	-20
3	-30
4	-40
5	-50
6	-60

Note: (1) One value can be lower than 47J but shall be 32J or higher

③: Chemical composition of all-weld metal

Code	Chemical composition (%) (1)			
	Mn	Ni	Cr	Mo
Z	Elements as agreed			
MnMo	1.4-2.0	-	-	0.3-0.6
Mn1Ni	1.4-2.0	0.6-1.2	-	-
Mn1, 5Ni	1.1-1.8	1.3-1.8	-	-
Mn2, 5Ni	1.1-2.0	2.1-3.0	-	-
1NiMo	1.4	0.6-1.2	-	0.3-0.6
1, 5NiMo	1.4	1.2-1.8	-	0.3-0.7
2NiMo	1.4	1.8-2.6	-	0.3-0.7
Mn1NiMo	1.4-2.0	0.6-1.2	-	0.3-0.7
Mn2NiMo	1.4-2.0	1.8-2.6	-	0.3-0.7
Mn2NiCrMo	1.4-2.0	1.8-2.6	0.3-0.6	0.3-0.6
Mn2Ni1CrMo	1.4-2.0	1.8-2.6	0.6-1.0	0.3-0.6

Note: (1) Single values are maximum.

④: Welding position

Code	Designation
1	All positions
2	All positions except vertical downward
3	Flat butt and fillet, Horizontal fillet
4	Flat butt and fillet
5	Vertical downward and those in Code 3

⑤: Diffusible hydrogen

Code	Diffusible hydrogen, Max. ml/100g deposited metal
H5	5
H10	10

⑧: Heat treatment: T: 560-600°C × 1h, FC to 300°C for mechanical tests of all-weld metal

Tubular cored electrodes for gas shielded metal arc welding of creep-resisting steels

Classification (System A)

EN ISO 17634-A - T ① ② ③ ④ ⑤

[Ex.] EN ISO 17634-A - T CrMo1 B M 4 H5

T: Designates tubular cored electrodes for gas shielded metal arc welding

①: Chemical composition and mechanical properties of all-weld metal

Code	Chemical composition (%)		
	Cr	Mo	V
Mo	-	0.40-0.65	-
MoL	-	0.40-0.65	-
MoV	0.30-0.60	0.50-0.80	0.25-0.45
CrMo1	0.90-1.40	0.40-0.65	-
CrMo1L	0.90-1.40	0.40-0.65	-
CrMo2	2.00-2.50	0.90-1.30	-
CrMo2L	2.00-2.50	0.90-1.30	-
CrMo5	4.00-6.00	0.40-0.70	-
Z	Elements as agreed		

②: Type of flux

Code	Features
R	Rutile, Slow-freezing slag
P	Rutile, Fast-freezing slag
B	Basic
M	Metal powder
Z	Other types

③: Shielding gas

Code	Designation
M	Gas mixtures (Gases specified as M2 per EN 439, excepting He)
C	CO ₂ (Gases specified as C1 per EN 439)

④: Welding position (Opt.)

Code	Designation
1	All positions
2	All positions except vertical downward
3	Flat butt and fillet, Horizontal fillet
4	Flat butt and fillet
5	Vertical downward and those in Code 3

⑤: Diffusible hydrogen (Option)

Code	Diffusible hydrogen, Max. ml/100g deposited metal
H5	5
H10	10

Mechanical properties of all-weld metal

Code	Proof strength, Min. Rp0.2 (N/mm ²)	Tensile strength, Min. Rm (N/mm ²)	Elongation (L=5D) Min. A (%)	Absorbed energy Kv (J) +20°C		Heat treatment of all-weld metal		
				Average of three values, Min. (J)	Single value, Min. (J)	Preheat and interpass temp. (°C)	PWHT	
							Temp. (1) (°C)	Time (min)
Mo/MoL	355	510	22	47	38	< 200	570-620	60±10
MoV	355	510	18	47	38	200-300	690-730	60±10
CrMo1	355	510	20	47	38	150-250	660-700	60±10
CrMo1L	355	510	20	47	38	150-250	660-700	60±10
CrMo2	400	500	18	47	38	200-300	690-750	60±10
CrMo2L	400	500	18	47	38	200-300	690-750	60±10
CrMo5	400	590	17	47	38	200-300	730-760	60±10
Z	Mechanical properties as agreed							

Note (1) Cooling speed: 200°C/1h max. to 300°C by FC

Tubular cored electrodes and rods for gas shielded and non-gas shielded metal arc welding of stainless and heat-resisting steels

Classification (System A)

EN ISO 17633-A - T ① ② ③ ④ [Ex.] EN ISO 17633-A - T 19 12 3L R M 4

T: Designates tubular cored electrodes for gas shielded and non-gas shielded metal arc welding

①: chemical composition and mechanical properties of all-weld metal

Classification	Chemical composition (%)				Proof strength Min. Rp0.2 (N/mm ²)	Tensile strength Min. Rm (N/mm ²)	El. (L=5D) Min. A %	PWHT
	Cr	Ni	Mo	Others				
Martensite/ferrite type								
13	11.0-14.0	—	—	—	250	450	15	(3)
13 Ti	10.5-13.0	—	—	Ti (1)	250	450	15	(3)
13 4	11.0-14.5	3.0-5.0	0.4-1.0	—	500	750	15	(4)
17	16.0-18.0	—	—	—	300	450	15	(5)
Austenite type								
19 9 L	18.0-21.0	9.0-11.0	—	—	320	510	30	None
19 9 Nb	18.0-21.0	9.0-11.0	—	Nb (2)	350	550	25	None
19 12 3 L	17.0-20.0	10.0-13.0	2.5-3.0	—	320	510	25	None
19 12 3 Nb	17.0-20.0	10.0-13.0	2.5-3.0	Nb (2)	350	550	25	None
19 13 4 N L	17.0-20.0	12.0-15.0	3.0-4.5	N: 0.08-0.20	350	550	25	None
Austenite-ferrite high corrosion resistant type								
22 9 3 N L	21.0-24.0	7.5-10.5	2.5-4.0	N: 0.08-0.20	450	550	20	None
Full-austenite high corrosion resistant type								
18 16 5 N L	17.0-20.0	15.5-19.0	3.5-5.0	N: 0.08-0.20	300	480	25	None
Special type								
18 8 Mn	17.0-20.0	7.0-10.0	—	—	350	500	25	None
20 10 3	19.5-22.0	9.0-11.0	2.0-4.0	—	400	620	20	None
23 12 L	22.0-25.0	11.0-14.0	—	—	320	510	25	None
23 12 2 L	22.0-25.0	11.0-14.0	2.0-3.0	—	350	550	25	None
29 9	27.0-31.0	8.0-12.0	—	—	450	650	15	None
Heat resistant type								
22 12 H	20.0-23.0	10.0-13.0	—	—	350	550	25	None
25 20	23.0-27.0	18.0-22.0	—	—	350	550	20	None

Note: (1) Ti :10×C%-1.5%

(2) Nb:8×C%-1.1%: Nb can be replaced with Ta up to 20%

(3) 840-870°C×2h heating, followed by FC to 600°C and later AC

(4) 580-620°C×2h heating, followed by AC

(5) 760-790°C×2h heating, followed by FC to 600°C and later AC

②: Type of flux

Code	Features
R	Rutile, Slow-freezing slag
P	Rutile, Fast-freezing slag
M	Metal powder
U	Self-shielded
Z	Other types

③: Shielding gas

Code	Designation
M	Gas mixtures (Gases specified as M2 per EN 439, excepting He)
C	CO ₂ (Gases specified as C1 per EN 439)
N	Self-shielded

④: Welding position (Option)

Code	Designation
1	All positions
2	All positions except vertical downward
3	Flat butt and fillet, and horizontal fillet
4	Flat butt and fillet
5	Vertical downward and those in Code 3

■ Alphabetical Index for Welding Consumables

KOBELCO

Global Manufacturing and Sales Bases

JAPAN

KOBE STEEL, LTD.
WELDING COMPANY, International Operations Dept.
9-12, Kita-Shinagawa 5-chome, Shinagawa-ku,
Tokyo, 141-8688 Japan
Tel: (81) 3-5739-6331, Fax: (81) 3-5739-6960

EUROPE

KOBELCO WELDING OF EUROPE B.V.
Eisterweg 8, 6422 PN, Heerlen, The Netherlands
Tel: (31) 45-547-1111 Fax: (31) 45-547-1100

USA

KOBELCO WELDING OF AMERICA INC.
HOUSTON HEAD OFFICE
4755 Alpine, Suite, 250, Stafford, Texas 77477, USA
Tel: (1) 281 240-5600, Fax: (1) 281 240-5625

KOREA

KOBE WELDING OF KOREA CO., LTD.
21-14, Palryong-Dong, Changwon, Kyongnam,
Republic of Korea
Tel: (82) 55-292-6886, Fax: (82) 55-292-7786

CHINA

KOBE WELDING OF TANGSHAN CO., LTD.
196, Huoju Road, Tangshan, New & Hi-Tech Development Zone,
Tangshan, Hebei, P. R. China, 063020
Tel: (86) 315-385-2806, Fax: (86) 315-385-2829

SINGAPORE

KOBE WELDING (SINGAPORE) PTE. LTD.
20, Pandan Avenue, Jurong, Singapore 609387,
Republic of Singapore
Tel: (65) 6268-2711, Fax: (65) 6264-1751

THAILAND

THAI-KOBE WELDING CO., LTD.
500, Moo 4 Soi 1, Bangpoo Industrial Estate, Sukhumvit
Road, Praeksa, Muang Samutprakarn 10280, Thailand
Tel: (66) 2-324-0588 up to 91, Fax: (66) 2-324-0797

KOBE MIG WIRE (THAILAND) CO., LTD.
491, Moo 4 Soi 1, Bangpoo Industrial Estate, Sukhumvit
Road, Praeksa, Muang Samutprakarn 10280, Thailand
Tel: (66) 2-324-0588 up to 91, Fax: (66) 2-324-0797

MALAYSIA

KOBE WELDING (MALAYSIA) SDN. BHD.
Plot 502, Jalan Perusahaan Baru, Kawasan Perusahaan
Prai, 13600 Prai, Malaysia
Tel: (60) 4-3905792, Fax: (60) 4-3905827

INDONESIA

PT. INTAN PERTIWI INDUSTRI
(Technically-Collaborated Company)
Jalan P Jayakarta 45, Block A/27, Jakarta 11110,
Indonesia
Tel: (62) 21-639-2608, Fax: (62) 21-649-6081